

SHDXL | XLERATOR™

HAND DRYER



XLERATOR

THE STANDARD IN HIGH VELOCITY

The first high velocity hand dryer on the market, the XLERATOR sets the standard for quality and performance in its category. The XLERATOR dries hands in seconds, making it the ultimate choice in washrooms with high traffic, such as stadiums, arenas and public places. Its reinforced, die-cast zinc alloy shell make it virtually unbreakable. The first choice for LEED® buildings, the XLERATOR is the ideal high velocity hand dryer!

DRIES HANDS IN ONLY 8 SECONDS†!

LED WARNING LIGHT IN CASE OF PROBLEMS

PERFECT FOR LEED® BUILDINGS

CHOICE OF 5 COLOURS AND CUSTOMIZATION WITH YOUR LOGO

COLOURS

- **standard:** white, white polymer BMC
- **luxurious finish:** chrome, graphite or brushed stainless steel (surcharge)

FINISH

- epoxy-polyester powdercoat

MANUFACTURING

- rib reinforced shell, solidly constructed of die-cast zinc alloy
- lightweight, unbreakable and rustproof
- secured to its supporting wall bracket with two chrome-plated, tamper-proof bolts

SOUND LEVEL

- 71 dBA (81 dBA with hands)

ELEMENT

- nichrome element producing instant heat

CONTROL

- infrared optical sensor located next to the air outlet activates hand dryer
- 35-second lockout feature is activated if hands are not removed before this time

INSTALLATION

- wall mounted

WARRANTY

- five years, *three years on electronic components

† Dry time and energy use testing performed by SGS International on standard XLERATOR Hand Dryer with 0.8 in. nozzle to 0.25 g or less of residual moisture, pursuant to the UL Environment Global Product Category Rules (PCR) for Hand Dryers.

TECHNICAL SPECIFICATIONS

PRODUCT	POWER (WATTS)			VOLTAGE	AMPERAGE	WEIGHT		PRICE			
	ELEMENT	MOTOR	TOTAL			KG	LB	W	BW	GR	CH OR SS
SHDXLAS1	1000	500	1500	120	12.5	7.3	16	933.00	851.00	986.00	1069.00
SHDXLAS2	1000	500	1500	208-240-277	6.5	7.3	16	933.00	851.00	986.00	1069.00









Add W for white, BW for white polymer BMC, CH for chrome, SS for brushed stainless steel or GR for graphite.

°STELPRO

°STELPRO reserves the right to modify descriptions, manufacturing specifications or prices without prior notice. No returns accepted on optional-colour products. For all the latest models and prices, please refer to our website at www.stelpro.com.



FC_SHDXL_EN_311018

	ENERGY SAVINGS	AIR SPEED OR AIR FLOW	HEATING POWER	NOISE LEVEL	DRYING TIME
ADJUSTABLE PARAMETERS: HEAT, MOTOR AND RANGE Ideal for: schools, arenas, stadiums and busy public places		 ADJUSTABLE			
					
					
					

*At maximum capacity

RECOMMENDED INSTALLATION HEIGHTS				
Distance between floor and bottom of hand dryer				
MEN	WOMEN	TEENAGERS	CHILDREN	HANDICAPPED
45 in. (115 cm)	43 in. (110 cm)	41 in. (105 cm)	35 in. (90 cm)	37 in. (95 cm)

CHOICE OF 5 COLOURS



PERSONALIZATION



Create a memorable impact by personalizing your hand dryer. Choose your colour and have your company logo printed right on the dryer. For more details, contact your °Stelpro representative.

ACCESSORIES

RECESS KIT

The recess kit is comprised of a stainless steel, satin finish wall box and mounting plate. When installed with the recess kit, the XLERATOR takes up less than 4 in. (10 cm) of wall depth, meeting ADA Protrusion Requirements (*Americans with Disabilities Act*).

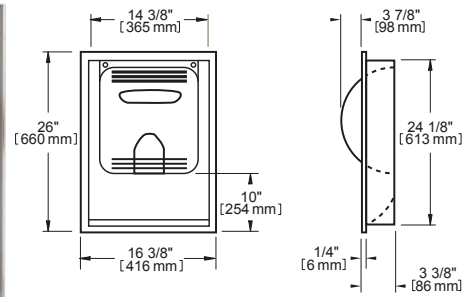

HEPA FILTRATION SYSTEM

°STELPRO offers the only certified HEPA filtration system proven to remove 99.97% of bacteria and particles from the air.

HEPA FILTER KIT

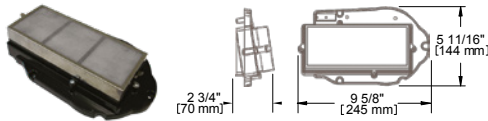

HEPA REPLACEMENT FILTER

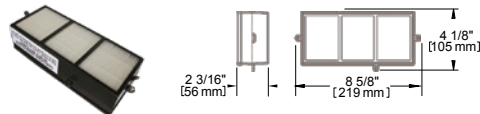

PRE-FILTER

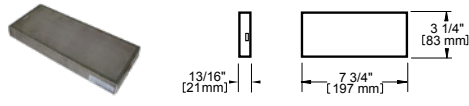

WALL GUARD

The wall guard protects the wall under the hand dryer from drops of water due to wet hands being blown dry, keeping bacteria from forming on the wall.



- WHITE
- BLACK
- STAINLESS STEEL

PRODUCT	DESCRIPTION	PRICE
SHDXL-40525	HEPA filter kit	332.00
SHDXL-40520	HEPA replacement filter	177.00
SHDXL-94	Replacement pre-filter with stainless steel mesh screen	56.00
SHDXL-40502	Stainless steel recess kit	353.00
SHDXL-89W	Wall guard - white (15 3/4 in. x 31 3/4 in. x 1/16 in. – 40 cm x 81 cm x 0.16 cm) – set of two	277.00
SHDXL-89B	Wall guard - black (15 3/4 in. x 31 3/4 in. x 1/16 in. – 40 cm x 81 cm x 0.16 cm) – set of two	277.00
SHDXL-89S	Wall guard - stainless steel (15 3/4 in. x 31 3/4 in. x 1/16 in. – 40 cm x 81 cm x 0.16 cm) – set of two	442.00

TECHNICAL DRAWINGS

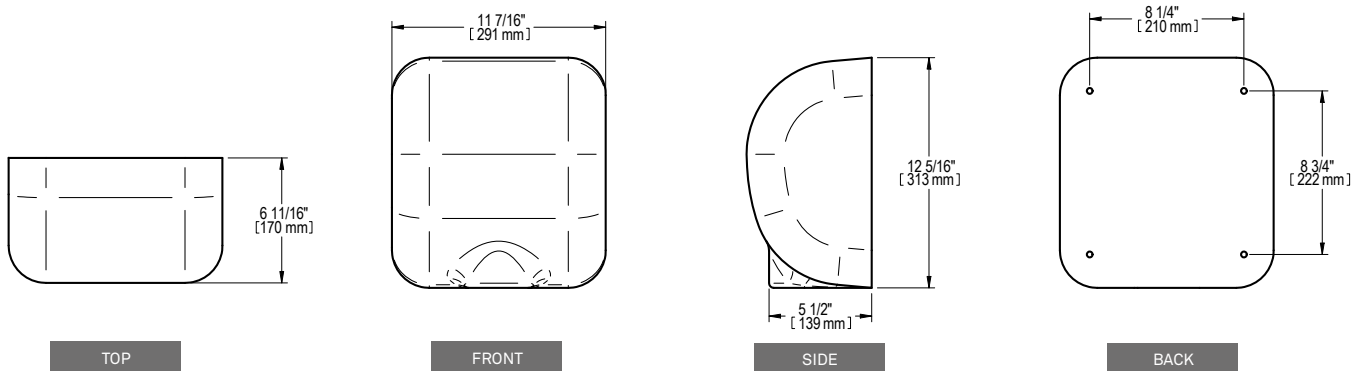

°STELPRO reserves the right to modify descriptions, manufacturing specifications or prices without prior notice. No returns accepted on optional-colour products. For all the latest models and prices, please refer to our website at www.stelpro.com.

