

R841

ELECTROMECHANICAL RELAY – LOW VOLTAGE



R841C1151



CONTROL

- all or nothing (on/off)
- with a 24 V transformer (except the R841D1036 w/o a transformer)
- compatible with the T822K1034, T87K1015 and ET180 thermostats (the R841D1036 w/o a transformer is also compatible with the STE241 and D010 thermostats)
- installing more than four relays without a transformer to the same thermostat is not recommended (two relays without a transformer if connected to a STE241 thermostat)
- no additional relay can be connected to the same control circuit as a relay with a transformer

INSTALLATION

- these relays can be installed in an external junction box
- these relays may or may not be installed in the junction box of the heating unit (see the accessories table for the heating unit)

WARRANTY

- one year

TECHNICAL DRAWINGS

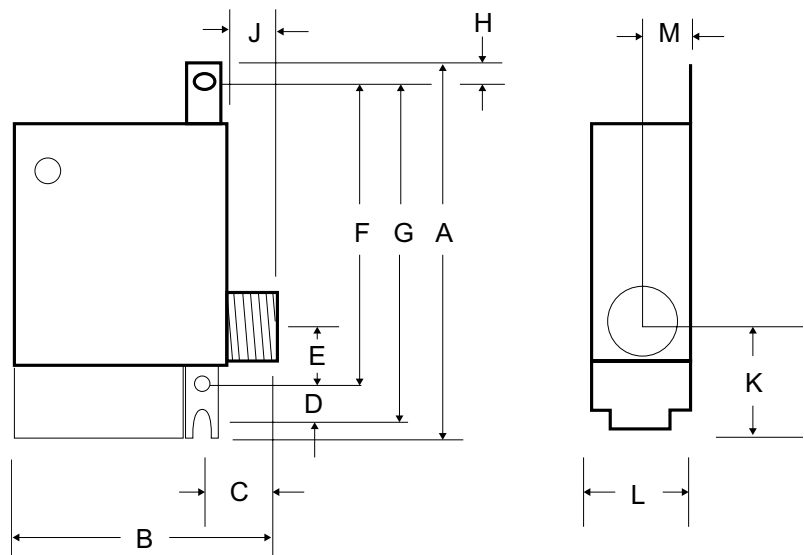

PRODUCT	DESCRIPTION	PRICE
R841C1151	ELECTROMECHANICAL RELAY C/W TRANSFORMER 24 V [6000 W @ 600 V]	91.00
R841D1036	ELECTROMECHANICAL RELAY W/O TRANSFORMER 24 V [6000 W @ 600 V]	73.00

DIMENSIONS												
KEY	A	B	C	D	E	F	G	H	J	K	L	M
MM (NOMINAL)	95	65	20	10	20	75	85	5	10	35	40	15
IN.	3 1/4	2 3/8	3/4	15/32	3/4	2 29/32	3 3/8	1/4	7/16	1 15/32	1 1/2	5/8