

RACK-MOUNTABLE BLOWERS

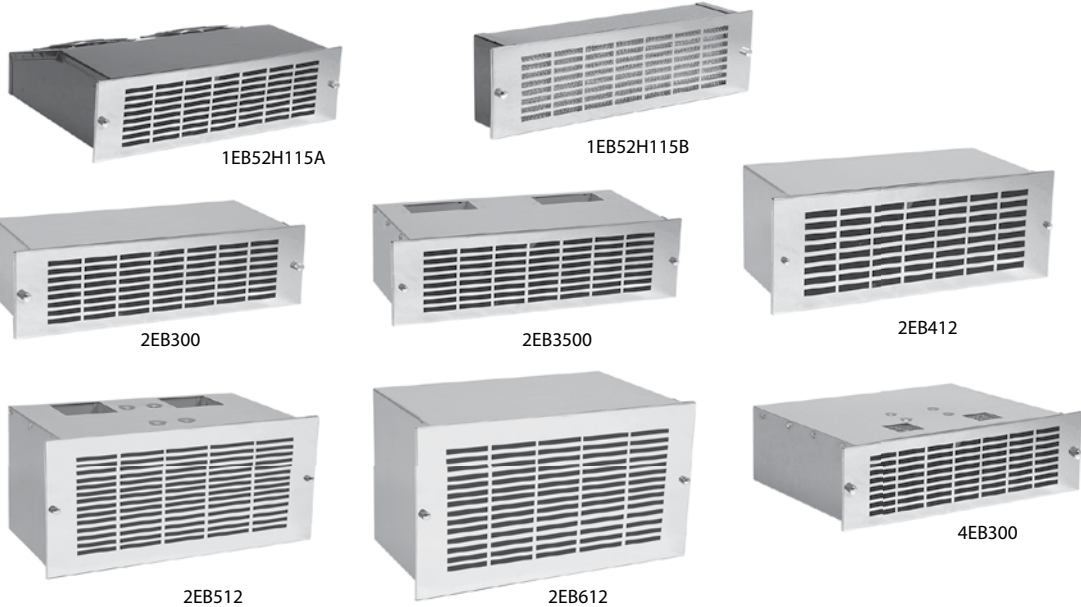

INDUSTRY STANDARDS

UL recognized

CSA Certified Motors
CE

APPLICATION

Fanpack packaged blowers are filtered inlet redundant fan packages. The compact size of the "B" models result in minimal intrusion into the enclosure.

Standard packaged blowers offer reliable rack cooling in a variety of case styles. Two exhaust styles are available with air flowing out the rear or out the top. Specify exhaust style (R or T) when ordering.

Multi-exhaust packaged blowers feature top and rear exhausts, for a wide, deep airflow pattern. Designed with two separate blowers inside, multi-exhaust blowers also offer redundancy and increased airflow.

FEATURES

- Permanent, Washable Aluminum Filter
- 19-in. Rack Mountable
- Brushed Aluminum Grille
- Exhaust Guard
- Power Cord
- Permanently lubricated ball bearing motors
- 100% functionally tested

SPECIFICATIONS

- 115/230 VAC
- 50/60 Hz

1EB Models

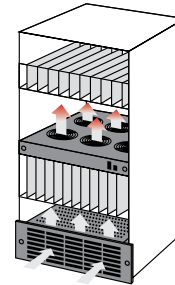

2EB Models

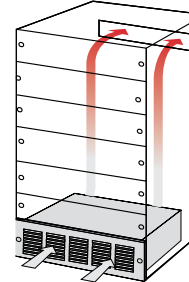

4EB Models

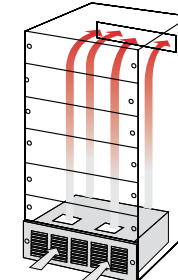

Performance Data **1EB Models**

ELECTRICAL DATA		
Rated Voltage	115	230
Frequency (Hz)	50/60	50/60
Maximum Operating Temperature (°F/°C)	140/60	140/60
"A" Models		
Catalog Numbers	1EB52H115A	1EB52H230A
Free Airflow (CFM/M ³ /hr.)	320/544	320/544
RPM	3300	3300
Nominal Run Current Maximum (Amps)	.52	.26
Nominal Start Current Maximum (Amps)	1.00	.50
Power Consumption (Watts)	62	62
Weight (lb./kg)	14/6.3	14/6.3
"B" Models		
Catalog Numbers	1EB52H115B	1EB52H230B
Free Airflow (CFM/M ³ /hr.)	235/400	235/400
RPM	3100	3100
Nominal Run Current Maximum (Amps)	.55	.31
Nominal Start Current Maximum (Amps)	.80	.40
Power Consumption (Watts)	44	44
Weight (lb./kg)	8/3.6	8/3.6

1EB52HxxxB Models

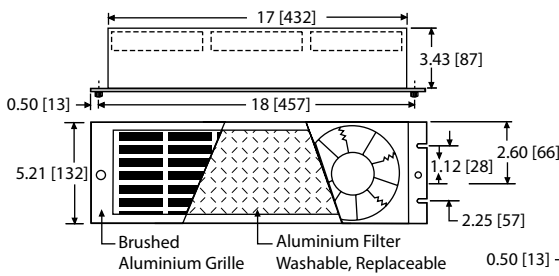

1EB52HxxxA Models

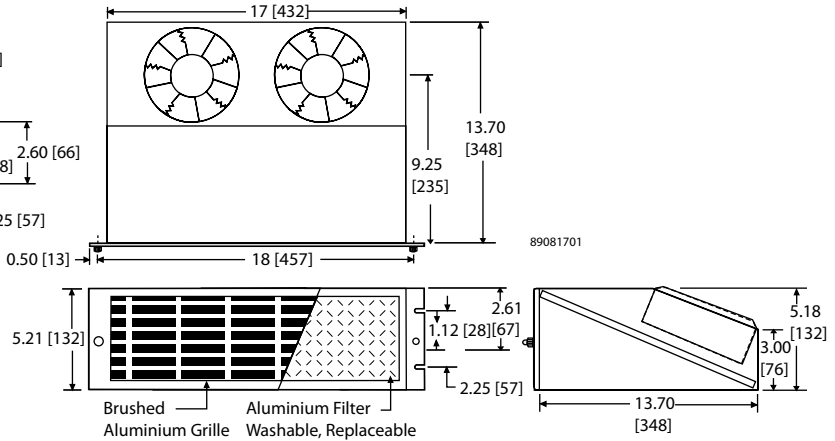

1EB Models

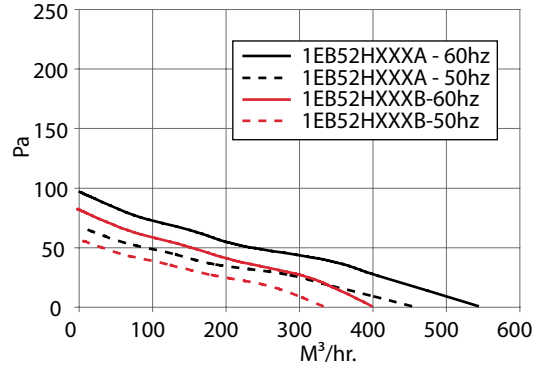
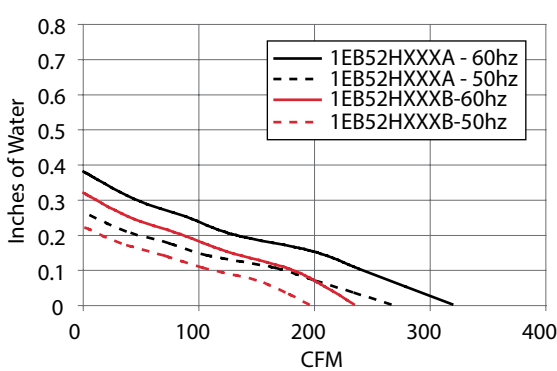

Performance Data 2EB Models

ELECTRICAL DATA		
Rated Voltage	115	230
Frequency (Hz)	50/60	50/60
Maximum Operating Temperature (°F/°C)	104/40	104/40
2EB300R Models		
Catalog Numbers	2EB300R115	
Free Airflow (CFM/M ³ /hr.)	125/212	
RPM	3000	
Nominal Run Current Maximum (Amps)	.9	
Power Consumption (Watts)	70	
Weight (lb./kg)	16/17.3	
2EB3500R Models		
Catalog Numbers	2EB3500R115	2EB3500R230
Free Airflow (CFM/M ³ /hr.)	290/493	290/493
RPM	3050	3050
Nominal Run Current Maximum (Amps)	1.8	.9
Power Consumption (Watts)	125	125
Weight (lb./kg)	17/7.7	17/7.7
2EB412R Models		
Catalog Numbers	2EB412R115	2EB412R230
Free Airflow (CFM/M ³ /hr.)	375/637	375/637
RPM	3100	3100
Nominal Run Current Maximum (Amps)	1.8	.8
Power Consumption (Watts)	200	200
Weight (lb./kg)	22/10	22/10
2EB512R Models		
Catalog Numbers	2EB512R115	
Free Airflow (CFM/M ³ /hr.)	425/722	
RPM	1700	
Nominal Run Current Maximum (Amps)	1.3	
Power Consumption (Watts)	140	
Weight (lb./kg)	25/11.3	
2EB512T Models		
Catalog Numbers	2EB512T115	
Free Airflow (CFM/M ³ /hr.)	425/722	
RPM	1700	
Nominal Run Current Maximum (Amps)	1.3	
Power Consumption (Watts)	140	
Weight (lb./kg)	25/11.3	
2EB612R Models		
Catalog Numbers	2EB612R115	2EB612R230
Free Airflow (CFM/M ³ /hr.)	800/1359	800/1359
RPM	1650	1650
Nominal Run Current Maximum (Amps)	2.2	1.0
Power Consumption (Watts)	220	220
Weight (lb./kg)	41/18.6	41/18.6

Design Data 2EB Models

CATALOG NUMBERS	PMax in./mm	A in./mm	B in./mm	C in./mm	D in./mm	E in./mm	F in./mm
2EB300R115	5.25/133	4.30/109	2.05/52	—	—	8.22/209	—
2EB3500R115	5.25/133	4.38/111	4.56/116	—	—	7.17/182	1.75/44
2EB412R115	7.00/178	4.23/107	3.15/80	—	—	8.22/209	—
2EB512R115	8.75/222	4.13/105	3.63/92	—	—	8.22/209	—
2EB512T115	8.75/222	4.13/105	3.63/92	.80/20	3.40/86	9.61/244	—
2EB612R115	10.50/267	4.38/111	3.99/101	—	—	10.22/620	—

2EB Models

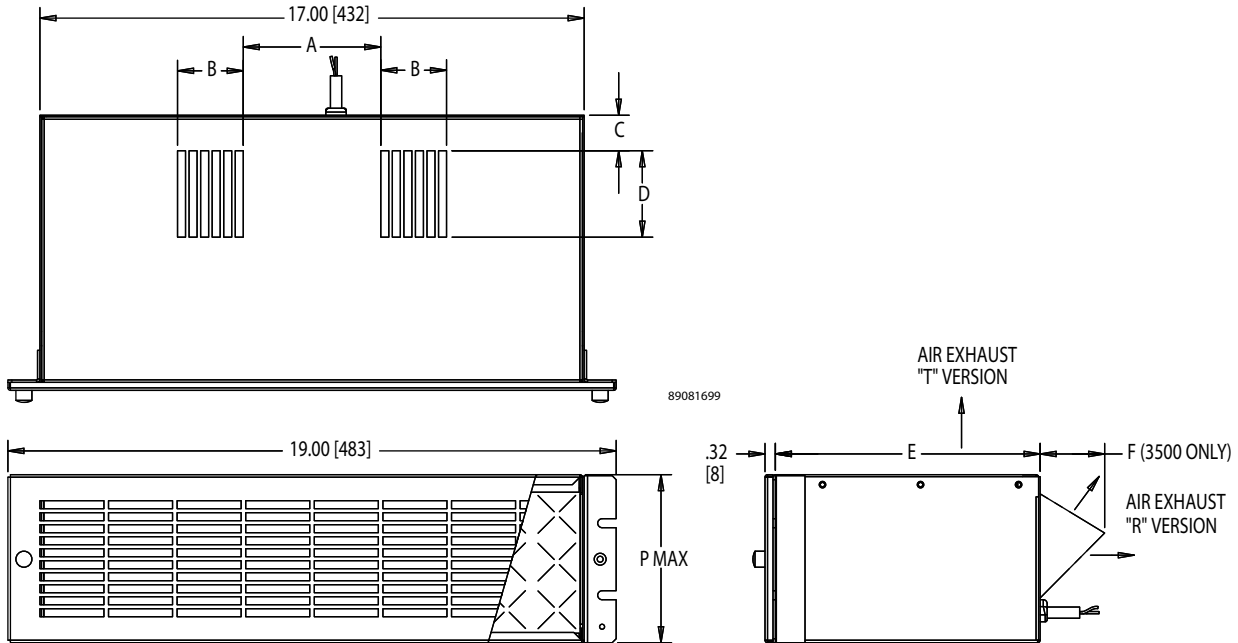

2EB Models

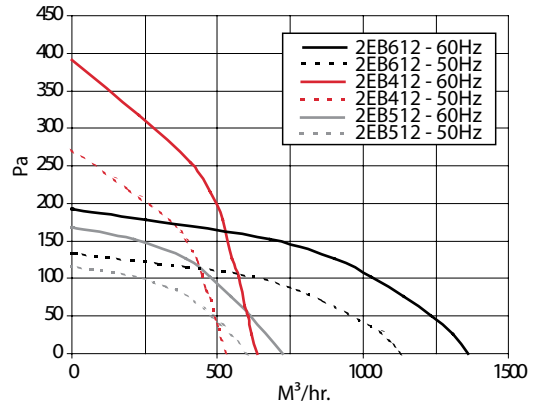
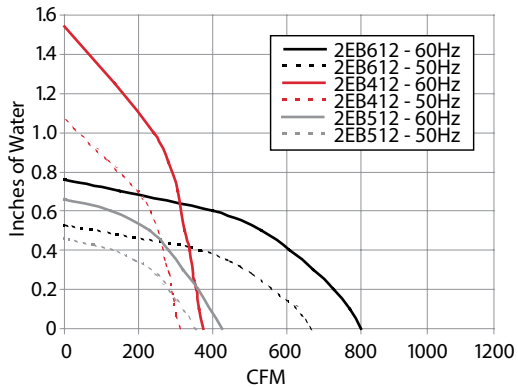
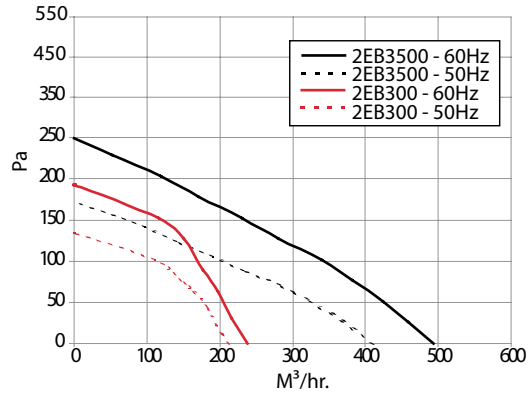
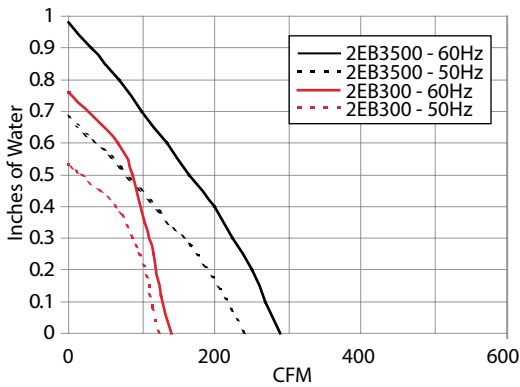

Performance Data **4EB Models**

ELECTRICAL DATA	
Rated Voltage	115
Frequency (Hz)	50/60
Maximum Operating Temperatur (°F/°C)	104/40
4EB300RT Models	
Catalog Number	4EB300RT115
Free Airflow (CFM/M ³ /hr.)	180/306
RPM	2900
Nominal Run Current Maximum (Amps)	2.0
Power Consumption (Watts)	130
Weight (lb./kg)	21/9.5

 Design Data **4EB Models**

CATALOG NUMBERS	PMax in./mm	A in./mm	B in./mm	C in./mm	D in./mm	E in./mm	F in./mm
4EB300RT115	5.25/133	4.30/109	2.05/52	7.25/184	2.70/69	12.88/327	—

4EB Models

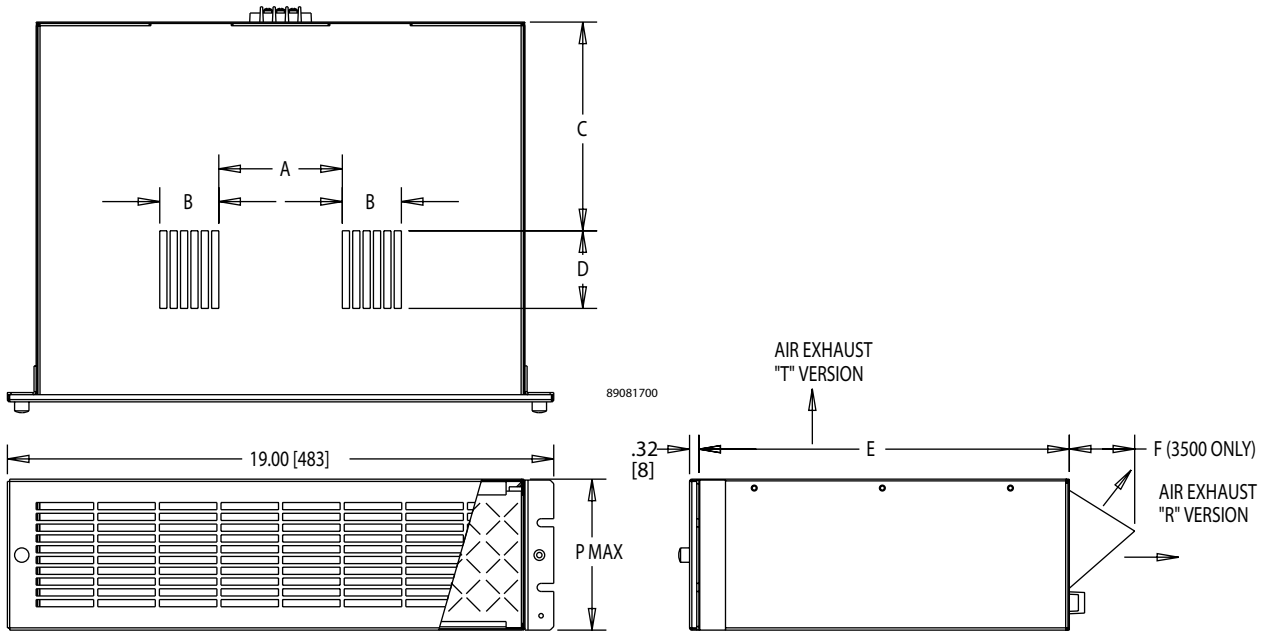

4EB Models

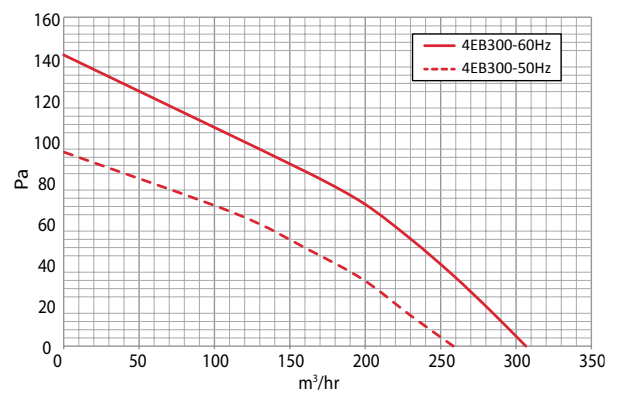
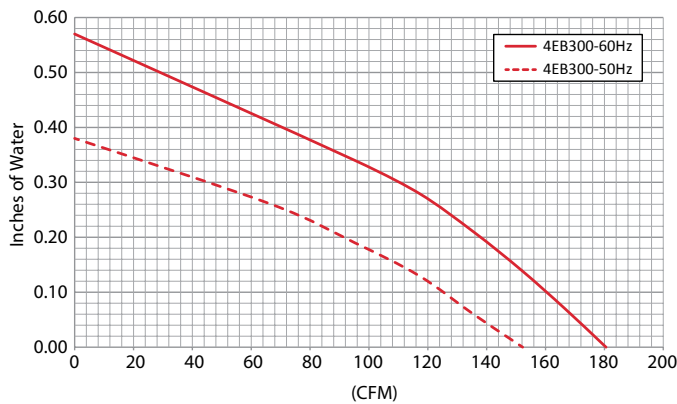

Notes