













Siemens  
EcoTech



EMERGENCY STOP mushroom pushbutton, 22 mm, round, plastic, red, 40 mm, positive latching, acc. to EN ISO 13850, rotate-to-unlatch



product brand name	SIRIUS ACT
product designation	EMERGENCY STOP mushroom pushbuttons
design of the product	Actuating/signaling element
product type designation	3SU1
product line	Plastic, black, 22 mm
<b>Enclosure</b>	
number of command points	1
<b>Actuator</b>	
design of the actuating element	positive latching
principle of operation of the actuating element	latching
product extension optional	
• light source	No
• contact module	Yes
color	
• of the actuating element	red
material of the actuating element	plastic
shape of the actuating element	round
outer diameter of the actuating element	40 mm
type of unlocking device	rotate-to-unlatch mechanism
number of switching positions	2
<b>Front ring</b>	
product component front ring	No
<b>General technical data</b>	
product function	
• positive opening	Yes
• EMERGENCY OFF function	Yes
• EMERGENCY STOP function	Yes
protection class IP	IP66, IP67, IP69(IP69K)
degree of protection NEMA rating	1, 2, 3, 3R, 4, 4X, 12, 13
shock resistance	
• according to IEC 60068-2-27	sinusoidal half-wave 15g / 11 ms
• for railway applications according to EN 61373	Category 1, Class B
vibration resistance	
• according to IEC 60068-2-6	10 ... 500 Hz: 5g
• for railway applications according to EN 61373	Category 1, Class B
operating frequency maximum	600 1/h
mechanical service life (operating cycles) typical	300 000

reference code according to IEC 81346-2	S	
Substance Prohibittance (Date)	10/01/2014	
<b>Safety related data</b>		
<b>proportion of dangerous failures</b>		
• with low demand rate according to SN 31920	20 %	
• with high demand rate according to SN 31920	20 %	
<b>B10 value with high demand rate according to SN 31920</b>	100 000	
<b>failure rate [FIT] with low demand rate according to SN 31920</b>	100 FIT	
<b>Ambient conditions</b>		
<b>ambient temperature</b>		
• during operation	-25 ... +70 °C	
• during storage	-40 ... +80 °C	
environmental category during operation according to IEC 60721	3M6, 3S2, 3B2, 3C3, 3K6 (with relative air humidity of 10 ... 95%)	
<b>Environmental footprint</b>		
Environmental Product Declaration(EPD)	Yes	
Global Warming Potential [CO2 eq] total	0.787 kg	
Global Warming Potential [CO2 eq] during manufacturing	0.566 kg	
Global Warming Potential [CO2 eq] during operation	0.235 kg	
Global Warming Potential [CO2 eq] after end of life	-0.015 kg	
Siemens Eco Profile (SEP)	Siemens EcoTech	
<b>Installation/ mounting/ dimensions</b>		
<b>shape of the installation opening</b>	round	
<b>mounting diameter</b>	22.3 mm	
<b>positive tolerance of installation diameter</b>	0.4 mm	
<b>mounting height</b>	45.3 mm	
<b>installation width</b>	40 mm	
<b>installation depth</b>	26.3 mm	
<b>Approvals Certificates</b>		
<b>General Product Approval</b>		
   <a href="#">Confirmation</a>  		
<b>General Product Approval</b>	<b>Test Certificates</b>	<b>Marine / Shipping</b>
	<a href="#">Type Test Certificates/Test Report</a>	<a href="#">Special Test Certificate</a>
		  
<b>Marine / Shipping</b>	<b>other</b>	<b>Environment</b>
	<a href="#">Confirmation</a>	   <a href="#">Environmental Confirmations</a>
<b>Further information</b>		
<b>Information on the packaging</b> <a href="https://support.industry.siemens.com/cs/ww/en/view/109813875">https://support.industry.siemens.com/cs/ww/en/view/109813875</a> <b>Information- and Downloadcenter (Catalogs, Brochures,...)</b> <a href="https://www.siemens.com/ic10">https://www.siemens.com/ic10</a> <b>Industry Mall (Online ordering system)</b> <a href="https://mall.industry.siemens.com/mall/en/en/Catalog/product?mlfb=3SU1000-1HB20-0AA0">https://mall.industry.siemens.com/mall/en/en/Catalog/product?mlfb=3SU1000-1HB20-0AA0</a> <b>Cax online generator</b> <a href="http://support.automation.siemens.com/WW/CAXorder/default.aspx?lang=en&amp;mlfb=3SU1000-1HB20-0AA0">http://support.automation.siemens.com/WW/CAXorder/default.aspx?lang=en&amp;mlfb=3SU1000-1HB20-0AA0</a> <b>Service&amp;Support (Manuals, Certificates, Characteristics, FAQs,...)</b> <a href="https://support.industry.siemens.com/cs/ww/en/ps/3SU1000-1HB20-0AA0">https://support.industry.siemens.com/cs/ww/en/ps/3SU1000-1HB20-0AA0</a>		

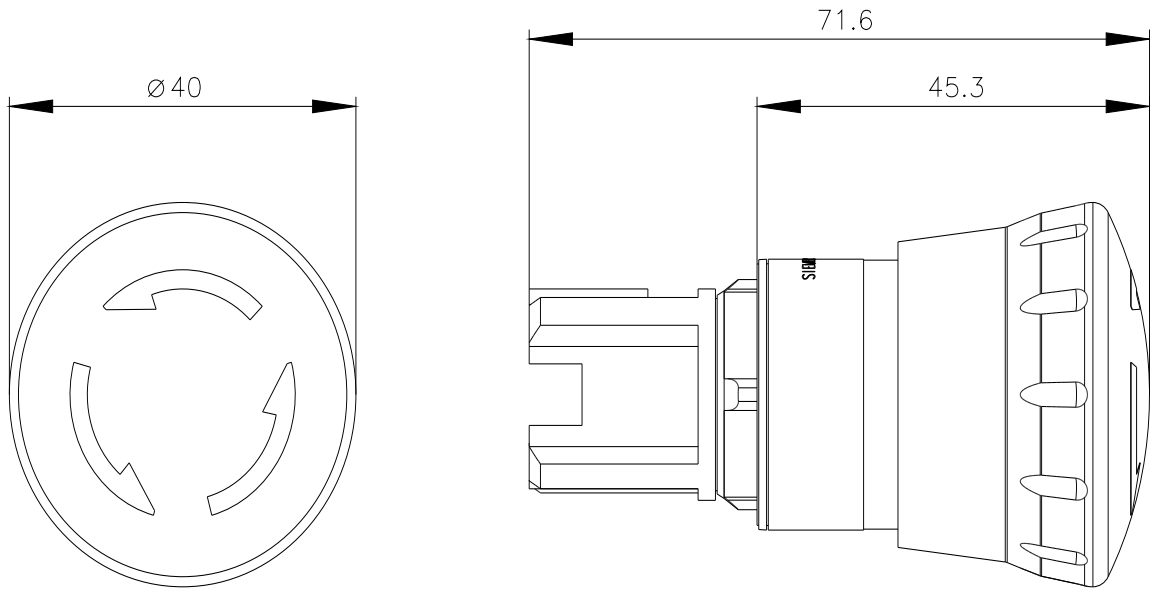

---

last modified:

2/7/2024 