

M22-XLED...

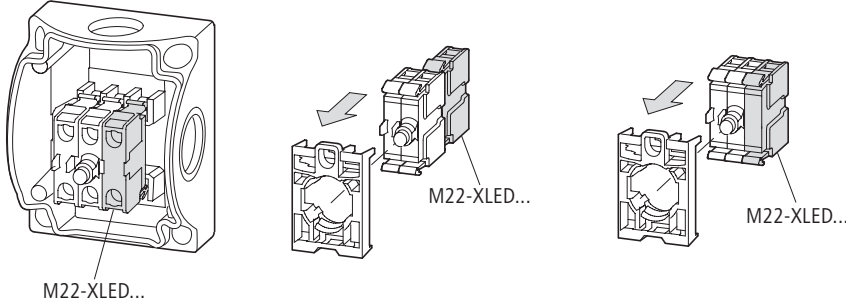

**M22-XLED60
 M22-XLED220**

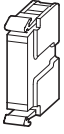
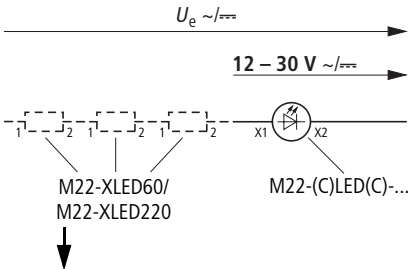

M22-XLED60	1 x	2 x	3 x	4 x	5 x	6 x	7 x
$U_{e [AC/DC]} \leq$	60 V	90 V	120 V	150 V	180 V	210 V	240 V
M22-XLED220	1 x						
$U_{e [AC/DC]} \leq$	220 V						

**M22-XLED-T
 M22-XLED60
 M22-XLED220**

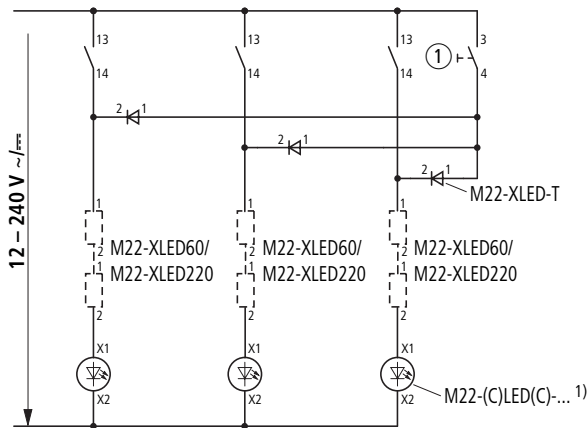

1) ~ 50/60 Hz → 12 - 30 V

M22-XLED230-T

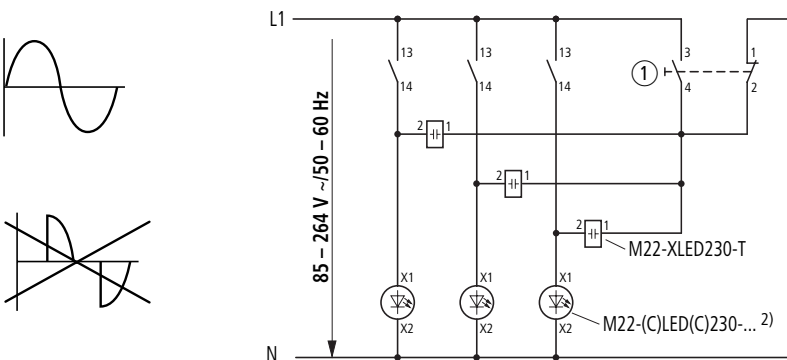

- ① Test button
- ① Tecla de prueba
- ① Touche d'essai
- ① Tasto di verifica
- ① Prüftaste
- ① Испытательная кнопка
- ① 筭突箇

2) ~ 50/60 Hz → 85 - 264 V

Dangerous Electrical Current!
 Only skilled qualified persons may carry out the following operations.

¡Corriente eléctrica! ¡Peligro de muerte!
 El trabajo a continuación descrito debe ser realizado por personas cualificadas y advertidas.

Tension électrique dangereuse !
 Seules les personnes qualifiées et averties doivent exécuter les travaux ci-après.

Lebensgefahr durch elektrischen Strom!
 Nur Elektrofachkräfte und elektrotechnisch unterwiesene Personen dürfen die im Folgenden beschriebenen Arbeiten ausführen.

Tensione elettrica: Pericolo di morte!
 Solo persone abilitate e qualificate possono eseguire le operazioni di seguito riportate.

Электрический ток! Опасно для жизни!
 Только специалисты или проинструктированные лица могут выполнять следующие операции.

触电危险!
 只允许专业人员和受过专业训练的人员进行下列工作。

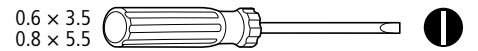
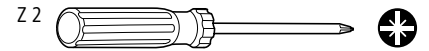

	2 x 0.75 - 2.5 mm ²	M ≤ 7.1 lb-in
	2 x 0.5 - 2.5 mm ²	
	2 x 0.5 - 2.5 mm ²	