





**READ AND FOLLOW ALL SAFETY INSTRUCTIONS!
SAVE THESE INSTRUCTIONS AND DELIVER TO OWNER AFTER INSTALLATION**

- To reduce the risk of death, personal injury or property damage from fire, electric shock, falling parts, cuts/abrasions, and other hazards please read all warnings and instructions included with and on the fixture box and all fixture labels.
- Before installing, servicing, or performing routine maintenance upon this equipment, follow these general precautions.
- Installation and service of luminaires should be performed by a qualified licensed electrician.
- Maintenance of the luminaires should be performed by person(s) familiar with the luminaires' construction and operation and any hazards involved. Regular fixture maintenance programs are recommended.
- It will occasionally be necessary to clean the outside of the refractor/lens. Frequency of cleaning will depend on ambient dirt level and minimum light output which is acceptable to user. Refractor/lens should be washed in a solution of warm water and any mild, non-abrasive household detergent, rinsed with clean water and wiped dry. Should optical assembly become dirty on the inside, wipe refractor/lens and clean in above manner, replacing damaged gaskets as necessary.
- **DO NOT INSTALL DAMAGED PRODUCT!** This luminaire has been properly packed so that no parts should have been damaged during transit. Inspect to confirm. Any part damaged or broken during or after assembly should be replaced.
- **Recycle:** For information on how to recycle LED electronic products, please visit www.epa.gov.
- These instructions do not purport to cover all details or variations in equipment nor to provide every possible contingency to meet in connection with installation, operation, or maintenance. Should further information be desired or should particular problems arise which are not covered sufficiently for the purchaser's or owner's purposes, this matter should be referred to Acuity Brands Lighting, Inc.

<div style="display: flex; align-items: center; margin-bottom: 10px;">  <div style="border: 1px solid black; padding: 5px; text-align: center; flex-grow: 1;"> <p>WARNING RISK OF ELECTRIC SHOCK</p> </div> </div> <ul style="list-style-type: none"> ✓ Disconnect or turn off power before installation or servicing. ✓ Verify that supply voltage is correct by comparing it with the luminaire label information. ✓ Make all electrical and grounded connections in accordance with the National Electrical Code (NEC) and any applicable local code requirements. ✓ All wiring connections should be capped with UL approved recognized wire connectors. 	<div style="display: flex; align-items: center; margin-bottom: 10px;">  <div style="border: 1px solid black; padding: 5px; text-align: center; flex-grow: 1;"> <p>WARNING RISK OF BURN</p> </div> </div> <ul style="list-style-type: none"> ✓ Allow lamp/fixture to cool before handling. Do not touch enclosure or light source. ✓ Do not exceed maximum wattage marked on luminaire label. ✓ Follow all manufacturer's warnings, recommendations and restrictions for: driver type, burning position, mounting locations/methods, replacement and recycling.
----------------------------------------------------------------------------------------------------------------------------------------------------------------------------------------------------------------------------------------------------------------------------------------------------------------------------------------------------------------------------------------------------------------------------------------------------------------------------------------------------------------------------------------------------------------------------------------------------------------------------------------------------------------------------------------------------------------------------------------------------------------------------------------------------------------------------------	---------------------------------------------------------------------------------------------------------------------------------------------------------------------------------------------------------------------------------------------------------------------------------------------------------------------------------------------------------------------------------------------------------------------------------------------------------------------------------------------------------------------------------------------------------------------------------------------------------------------------------------------------------------------------------------------------------------------------

<div style="display: flex; align-items: center; margin-bottom: 10px;">  <div style="border: 1px solid black; padding: 5px; text-align: center; flex-grow: 1;"> <p>CAUTION RISK OF INJURY</p> </div> </div> <ul style="list-style-type: none"> ✓ Wear gloves and safety glasses at all times when removing luminaire from carton, installing, servicing or performing maintenance. ✓ Avoid direct eye exposure to the light source while it is on. 	<div style="display: flex; align-items: center; margin-bottom: 10px;">  <div style="border: 1px solid black; padding: 5px; text-align: center; flex-grow: 1;"> <p>CAUTION RISK OF FIRE</p> </div> </div> <ul style="list-style-type: none"> ✓ Keep combustible and other materials that can burn, away from lamp/lens. ✓ Do not operate in close proximity to persons, combustible materials or substances affected by heat or drying.
-----------------------------------------------------------------------------------------------------------------------------------------------------------------------------------------------------------------------------------------------------------------------------------------------------------------------------------------------------------------------------------------------------------------------------------------------------------------------------------------------------------------------------------------------------------------------------------------------------	------------------------------------------------------------------------------------------------------------------------------------------------------------------------------------------------------------------------------------------------------------------------------------------------------------------------------------------------------------------------------------------------------------------------------------------------------------------------------------------------------------------------------------------------------------------------------------------



CAUTION: RISK OF PRODUCT DAMAGE

- ✓ Never connect components under load.
- ✓ Do not mount or support these fixtures in a manner that can cut the outer jacket or damage wire insulation.
- ✓ Controls for dimming, auto-sensing, or remote control of a luminaire that are not factory-wired to the luminaire must be checked for compatibility with the luminaire prior to installation. LED fixtures must be powered directly off a switched circuit.
- ✓ Unless individual product specifications deem otherwise: Do not restrict fixture ventilation. Allow for some volume of airspace around fixture. Avoid covering LED fixtures with insulation, foam, or other material that will prevent convection or conduction cooling.
- ✓ Unless individual product specifications deem otherwise: Do not exceed fixtures maximum ambient temperature.
- ✓ Only use fixture in its intended location.
- ✓ LED products are Polarity Sensitive. Ensure proper Polarity before installation.
- ✓ Electrostatic Discharge (ESD): ESD can damage LED fixtures. Personal grounding equipment must be worn during all installation or servicing of the unit.
- ✓ Do not touch individual electrical components as this can cause ESD, shorten lamp life, or alter performance.
- ✓ Some components inside the fixture may not be serviceable. In the unlikely event your unit may require service, stop using the unit immediately and contact an ABL representative for assistance.
- ✓ Always read the fixtures complete installation instructions prior to installation for any additional fixture specific warnings.
- ✓ Always ensure that the electrical distribution system is up to NEC (and any applicable local code) requirements.
- ✓ Verify that power distribution system has proper grounding. Lack of proper earth ground can lead to fixture failure and may void warranty.

Please see product specific installation instructions for additional warnings or any applicable FCC or other regulatory statements.

Failure to follow any of these instructions could void product warranties. For a complete listing of product Terms and Conditions, please visit www.acuitybrands.com.

Our Brands	Indoor/Outdoor Lithonia Lighting Carandini Holophane RELOC Light Concepts	Indoor Lighting Gotham Mark Architectural Lighting Peerless Renaissance Lighting Winona Lighting	Outdoor Lighting American Electric Lighting Antique Street Lamps Hydrel Tersen	Controls DARK TO LIGHT LC&D ROAM Sensor Switch Synergy	Daylighting SunOptics
-------------------	-------------------------------------------------------------------------------------------------	------------------------------------------------------------------------------------------------------------------------	---------------------------------------------------------------------------------------------------	------------------------------------------------------------------------------	---------------------------------

Acuity Brands Lighting, Inc. assumes no responsibility for claims arising out of improper or careless installation or handling of its products.

ABL LED General Warnings, Form No. 503.203

© 2010 Acuity Brands Lighting, Inc. All rights reserved. 12/01/10

Installation Instructions

DSXF LED

5 year limited warranty

DELIVERY: Upon receipt of fixture and accessories (packed separately), thoroughly inspect for any freight damage. All damage should be reported to the delivery carrier. Compare the catalog description listed on the packing slip with the fixture label on the inside of the housing to be sure you have received the correct merchandise.

This device complies with Part 15 of the FCC Rules. Operation is subject to the following two conditions: (1) this device may not cause harmful interference, and (2) this device must accept any interference received, including interference that may cause undesired operation.

Prior to Installation--Read carefully before installing light fixtures. If you do not understand these instructions, please contact your local Lithonia Lighting distributor before installing.

NOTE: Horizontal mounting of a fixture with the photocontrol receptacle option (PER)-- Section C136.10 ANSI, 4.5.2--The seat of the receptacle shall be mounted as close to horizontal as possible. If it deviates more than 45° from horizontal, the integrity of the seal may be affected when a control device is installed.

Tools Required: 9/64" and 3/16" hex key. 1/4" and 5/16" hex socket, regular screwdriver

1. Mounting

Threaded Knuckle Mount (THK): DSXF1 and DSXF2 Knuckle (1/2" NPT threaded nipple) or DSXF3 (3/4" NPT threaded nipple) mount directly to compatible NPTF apparatus. Secure the knuckle to desired mounting apparatus by tightening the locknut (not included). To adjust the tilt angle of the fixture, loosen the 3/16" hex key screw. Adjust as necessary and retighten to 75 in-lbs. Supply leads exit the knuckle mount to make connections in wiring compartment (not provided).

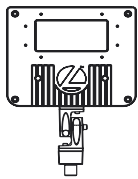

DSXF1 (1/2" knuckle)

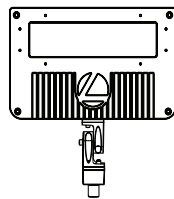

DSXF2 (1/2" knuckle)

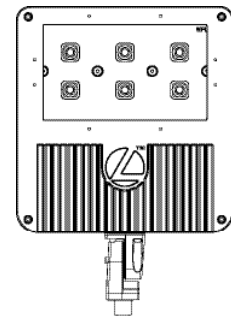

DSXF3 (3/4" knuckle)

Yoke Mount (YK):

For the center hole, it is recommended to use a 5/8" bolt with corresponding lock washer and nut. For the outer two holes or slots, it is recommended to use 1/2" bolts with corresponding lock washers and nuts. **NOTE:** Mounting hardware is not included and it is up to the installer to determine the most appropriate hardware for the desired mounting location. To adjust the tilt angle of the fixture, loosen the hex socket screw on each side of the yoke. While holding weight of fixture, remove hexhead set screw, adjust as necessary and reinstall in appropriate matching hole. If a non-standard angle is desired, adjust to angle and center punch inside yoke bracket and drill a .147in(#26) hole. Drive self-tapping hexhead set screw into new hole. Once the appropriate angle is set, tighten hex socket set screws to 75in-lbs. Make the supply connections to the 16-3 cord supplied.

DSXF1
DSXF2 YOKE

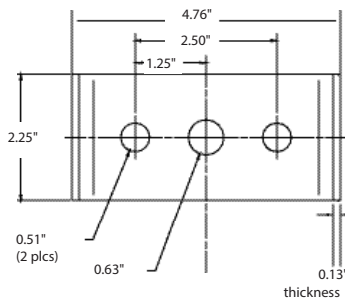

Yoke Mounting Plate Templates

Note: This drawing is NOT to scale and should be used for dimensional purpose only.

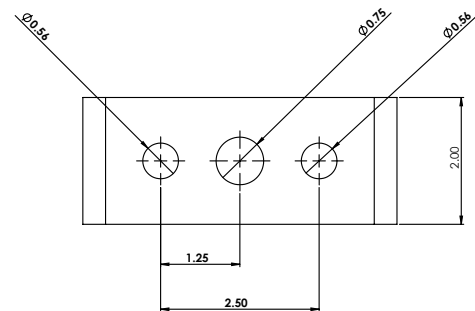

DSXF3
YOKE

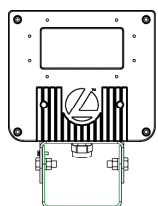

DSXF1 with yoke

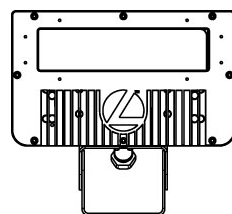

DSXF2 with yoke

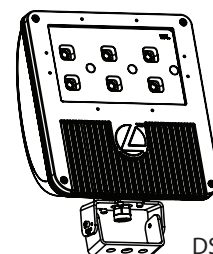

DSXF3 with yoke

Installation Instructions

DSXF LED

DSXF1/DSXF2/DSXF3 (ships installed): Remove the access cover plate to the integral wiring compartment using a 1/4" hex socket or regular screwdriver. Slip integral slipfitter onto tenon ensuring that the wires are pulled through the integral wiring compartment without pinching. Secure the slipfitter to the tenon by tightening the 3/16" hex socket set screws to 12 ft.-lbs. To adjust the tilt angle of the fixture, loosen the 5/16" hex socket screw above the integral wiring compartment. Adjust as necessary and retighten to 75 in.-lbs. Make supply connections through the integral wiring compartment. There are two wiring compartment cover plates, one without through hole and one that includes 7/8" through hole. If supply wires are coming through inside of tenon, use the cover plate without through hole. Use the plate with through hole if supply wires are being routed from a source outside of the tenon, such as surface or flexible conduit. Tighten the # 8-32 cover plate screws to 25 in.-lbs. When using the plate with through hole, use connectors rated for liquid tight sealing. Push wires into compartment. Re-install the access cover plate.

DSXF1 (Integral slipfitter)

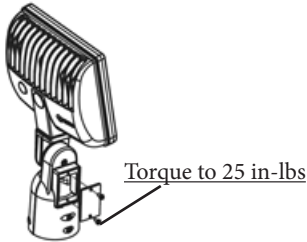

DSXF2 (Integral slipfitter)

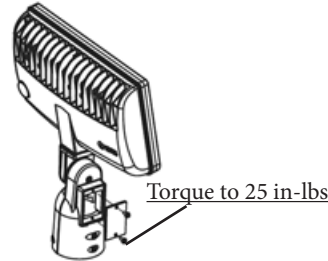

DSXF3 (Integral slipfitter)

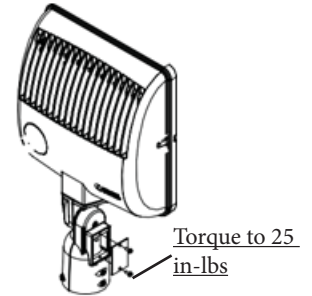

Shielding Options:

Attach with the 8-32 thread forming screws (provided) using the pre-drilled holes in the doorframe. Should the doorframe holes need be cleared for any reason, drill no deeper than 1/4" with a .147" (#26) diameter drill.

UBV
UPPER or BOTTOM
VISOR

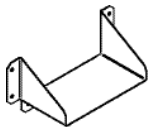

DSXF1 UV or BV

FV
FULL VISOR

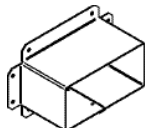

DSXF1 FV

VG
VANDAL
GUARD

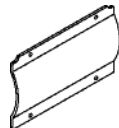

DSXF1 VG

WG
WIRE GUARD
(DSXF3 only)

N/A

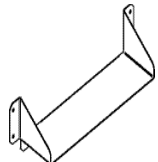

DSXF2 UV or BV

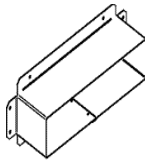

DSXF2 FV

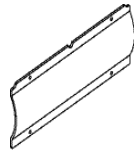

DSXF2 VG

N/A

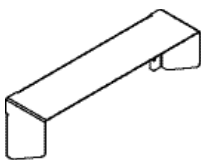

DSXF3 UV or BV

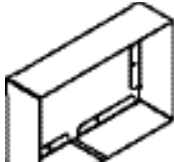

DSXF3 FV

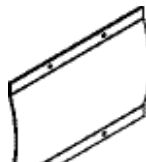

DSXF3 VG

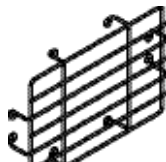

DSXF3 WG

Tenon Slipfitter (DSXF1/2TS) Installation (for use with THK mounting option):

Attach DSXF1/2TS to fixture's threaded 1/2" knuckle.

Secure to the top end of 1-1/4" to 2" pipe by tightening set screws to 12 ft.-lbs and lock down with jam nuts.

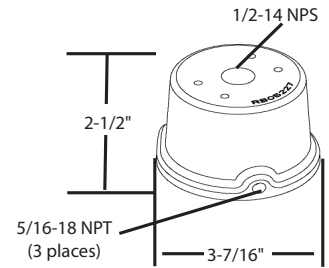

nLight AIR rIQ: Only available in DSXF2

1. Remove antenna tape and discard. (fig 1)
2. Fasten female end of antenna to protruding male connector on the cover plate. (fig 2)
3. Fasten antenna torque to 8-10 in.-lbs.

fig 1

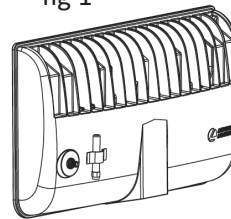
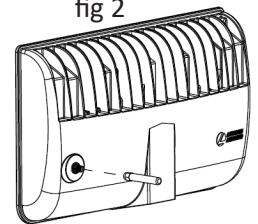

fig 2



Troubleshooting: If this fixture fails to operate properly, check to make sure: • The fixture is wired correctly. • The fixture is grounded correctly. • The line voltage at the fixture is correct. If all these variables have been checked and the fixture still does not operate as specified, contact your local Lithonia Lighting distributor.



SCAN ME