



USER'S GUIDE

STE241

LOW VOLTAGE

ELECTRONIC THERMOSTAT (24V)



For further information or to consult this guide online, please visit our website at www.stelpro.com

INSSTE2410622



WARNING

Before installing and operating this product, the owner and/or installer must read, understand and follow these instructions and keep them handy for future reference. If these instructions are not followed, the warranty will be considered null and void and the manufacturer deems no further responsibility for this product. Moreover, the following instructions must be adhered to in order to avoid personal injuries or property damages, serious injuries and potentially fatal electric shocks. All electric connections must be made by a qualified electrician, according to the electric and building codes effective in your region. Do NOT connect this product to a supply source other than 24 VAC and do not exceed the load limits specified. Protect the heating system with the appropriate circuit breaker or fuse. You must regularly clean dirt accumulations on the thermostat. Do NOT use fluid to clean thermostat air vent. Do not install thermostat in a wet place. However, installing it in isolated walls is allowed.

Note:

When a part of the product specification must be changed to improve operability or other functions, priority is given to the product specification itself. In such instances, the instruction manual may not entirely match all the functions of the actual product.

Therefore, the actual product and packaging, as well as the name and illustration, may differ from the manual.

The screen/LCD display shown as an example in this manual may be different from the actual screen/LCD display.

DESCRIPTION

The STE241 low voltage electronic thermostat (24 V) is designed to control relays (electronic or not). The allowed resistive maximum load is 12 W at 24 V (0.5 A). Then, relays (electronic or not) connected to the thermostat can control electric baseboards with or without fans, convectors, fan heaters and electric furnaces. This thermostat can be connected to Stelpro relays (with or without transformers). Moreover, the triac contact is really quiet.

This thermostat is not compatible with the following installations:

- resistive load of more than 12 W at 24 VAC (0.5 A)

Parts supplied:

- one (1) thermostat
- two (2) mounting screws

INSTALLATION

Selection of thermostat location

The thermostat must be mounted on a wall facing the heating unit, at around 1.5 m (5 feet) above the floor level, on a section of the wall exempt from pipes or air ducts.

Do not install the thermostat in a location where temperature measurements could be altered. For example:

- close to a window, on an external wall, or close to a door leading outside
- exposed directly to the light or heat of the Sun, a lamp, a fireplace or any other heat source
- close or in front of an air outlet
- close to concealed ducts or a chimney
- in a location with poor air flow (e.g. behind a door), or with frequent air drafts conditions (e.g. head of stairs).

Thermostat mounting and connection

1. Ensure that the air vents of the thermostat are clean and clear of any obstruction.
2. Using a screwdriver, loosen the screw retaining the mounting base and front part of the thermostat. Remove the front part of the thermostat from the mounting base by tilting it upward.

N.B. The following photos show a connection box installation as a reference only. A connection box is not necessary or required.



3. Align and secure the mounting base using the two screws supplied.



4. Connect the wires coming from the 24 VAC power source following the appropriate diagram below:

CONNECTION EXAMPLE #1

One baseboard with a STELPRO RE-153T electronic relay with a 24 VAC transformer.

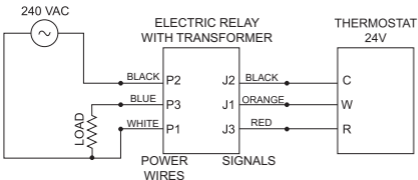

CONNECTION EXAMPLE #2

Two baseboards, with one connected to a Stelpro RE-153T electronic thermostat with a 24 VAC transformer, and with the second baseboard connected to a Stelpro RE-153 electronic thermostat without a 24 VAC transformer.

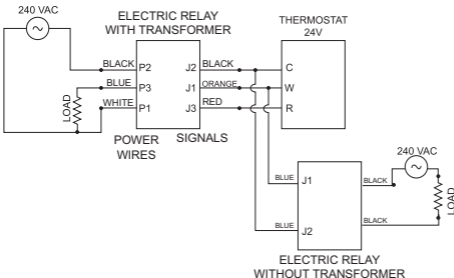

CONNECTION EXAMPLE #3

Standard 24 VAC power source (24 VAC transformer)

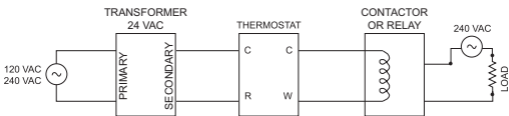

NOTE: the color of the wires can change according to the electronic relays that are used. Connection diagrams in this guide are only examples.

5. Reinstall the front part of the thermostat on the mounting base and tighten the screw at the bottom of the unit.



6. Turn on the power.
7. Set the thermostat to the desired setting (see the following section).

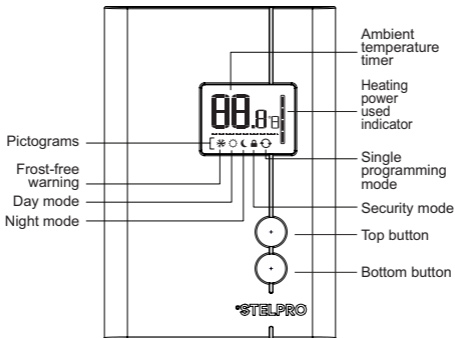

Initial start up



When powering on for the first time, the thermostat is initially set to Day mode . The temperature is displayed in Celsius and is set at 21 degrees by default.

Temperature set points

The figures displayed above the pictogram indicate the temperature set point. It can be displayed in degrees Celsius or Fahrenheit (see "Display in degrees Celsius/Fahrenheit").

To adjust the set point, just press down the top button to increase the value, or the bottom button to decrease it. Set points can be adjusted by increments of 0.5°C (1°F). To quickly scroll through the set point values, press and hold down the button. The minimum set point is 3°C (37°F), and the maximum set point is 30°C (86°F). In Day mode, you can turn off the thermostat by lowering the set point below 3°C. The set point value displayed will be --., and heating system start up will be impossible.

Day mode and Night mode

The thermostat includes a Day mode  and a Night mode , both of them having their own independently adjustable and recorded set point. When switching from one mode to the other, the system will automatically use the temperature set point corresponding to the Day/Night mode selected. The standard factory set point adjustment is 21°C (70°F) for the Day mode, and 18°C (64°F) for the Night mode.

The current Day/Night mode selection is indicated on the display by the Sun or Moon icon. In order to manually switch from one mode to the other, simultaneously press down the two buttons and release them immediately.

Night mode timer

The Night mode features a timer that automatically returns to the Day mode after a selectable time period. This timer allows the temporary use of a temperature set point. The standard factory adjustment of the timer is 8 hours. With this adjustment, the thermostat automatically returns to Day mode 8 hours after being switched to the Night mode.

For example, if you want a night temperature lower than the day temperature, both Day/Night mode set points will first have to be set at the desired temperatures. Before bedtime, the Night mode temperature set point will be activated by switching manually to the Night mode. The timer is set for the duration of the night. The thermostat will automatically return to the Day mode at the end of the night, and the Day mode temperature set point, which is higher, will become effective at this time.

Night mode timer adjustment procedure

1. If necessary, adjust the Day/Night mode set points at the desired temperatures. If needed, switch from one mode to the other by simultaneously pressing down the two buttons and releasing them immediately.
2. From the Night mode, simultaneously press down the two buttons for more than 3 seconds until the Moon icon blinks.
3. If needed, adjust the timer by pressing down the top button to increase the value, or the bottom button to decrease it. The adjustment range is from 1 hour to 999 hours. To quickly scroll through timer values, press and hold down the button.

4. When the adjustment is completed, release the buttons and wait for 5 seconds to exit the adjustment function.

NOTE: The Night mode timer will be automatically reinitialized to the latest recorded value when switching from the Day mode to the Night mode. It is not necessary to readjust the timer every time you switch to the Night mode. The timer is also reinitialized when this value is adjusted. Once the timer has completed its cycle and when the thermostat is in the Day mode, you must manually return to the Night mode. If you want to automatically return to the Night mode, the Single programming mode must be selected.

Single programming mode

The Single programming mode, which is associated with the Night mode timer, allows alternating between the Day/Night modes and the two corresponding set points over a 24-hour period. Once activated, this mode allows an automatic return to the Night mode after 24 hours. The Single programming mode allows you to define two periods in a single day with different set points.

For example, if the Single programming mode is activated and the Night mode timer is set at 8 hours, the thermostat will be operating in the Night mode for 8 hours at the night temperature set point. Then, it will return to the Day mode for 16 hours operating at the day temperature set point. At the end of the 24-hour cycle, the thermostat will return to the Night mode, and the cycle will start over. The 24-hour cycle starts with the Night mode as soon as the Single programming mode is activated. The Single programming mode activation should be made when you want to return to the Night mode. The normal course of a cycle in the Single programming mode is as follows:

- 1- Night mode: activated for the duration of the Night mode timer cycle. It returns to the Day mode when the timer cycle is completed.
- 2- Day mode: activated for the remaining time of the 24-hour cycle. It returns to the Night mode at the end of the 24-hour cycle.

Adjustment procedure of the Single programming mode:

1. If necessary, adjust the Day/Night set point at the desired temperatures. If needed, switch from one mode to the other by simultaneously pressing down the two buttons and releasing them immediately.

2. From the Night mode, simultaneously press down the two buttons for more than 3 seconds. If needed, adjust the timer by pressing down the top button to increase the value, or the bottom button to decrease it. The Night mode timer adjustment range is from 1 hour to 23 hours in the Single programming mode. To quickly scroll through the timer values, press and hold the bottom button.

NOTE: If you set the timer to any value exceeding 23 hours, it will be impossible to activate the Single programming mode and if it was activated, the Single programming mode will be deactivated.

3. Activate the Single programming mode by simultaneously pressing down the two buttons for at least 3 seconds. The  icon will appear. If the Single programming mode was already activated, the same procedure should be used to deactivate it.
4. When the adjustment is completed, release the buttons and wait for 5 seconds to exit the adjustment function.

NOTE: It is always possible to manually change the Day/Night mode during a 24-hour cycle. However, any manual return to the Night mode will re-initialize the Night mode timer to the latest value recorded, which modifies the cycle in progress. In all cases, at the end of the 24-hour cycle, the thermostat will return to the Night mode and start a new cycle. It is thus not necessary to readjust the Single programming mode when a manual change is made to the Day/Night mode.

When turning back on after being powered off (because of a power failure, for example), the Single programming mode is deactivated, and, if previously activated, the  icon will blink. The blinking will stop as soon as you press down a button.

Display in either degrees Celsius/Fahrenheit





The thermostat can display the ambient temperature and the set point in degrees Celsius (standard factory setting) or Fahrenheit.

1. From the day mode, simultaneously press down the two buttons for 8 seconds until the Celsius/Fahrenheit symbol blinks. Release the buttons.
2. Press down the top button to switch from the degrees Celsius to the degrees Fahrenheit, and conversely. The degree Celsius or Fahrenheit symbol will be displayed.

- When the adjustment is completed, release the buttons and wait for 5 seconds to exit the adjustment function.

Heating Power Indicator

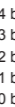
The level of power used to maintain the temperature at the set point is expressed as a percentage indicated by the number of bars in the thermometer displayed. The heating power used is displayed as follows:

	4 bars = 75% to 100%
	3 bars = 50% to 75%
	2 bars = 25% to 50%
	1 bar = 1% to 25%
	0 bar = no heat

Frost-free warning ❄️

The Snowflake icon is displayed when the temperature set point is between 3°C (37°F) and 5°C (41°F). A minimum temperature will be maintained to ensure frost control.

Security mode 🔒



It is possible to impose a maximum temperature set point by activating this mode. Then, it becomes impossible to exceed this set point, regardless of the current mode (Day/Night). However, it is still possible to lower the set point at your discretion.

Procedures to activate the Security mode

- To activate the Security option, from the Day mode adjust the day set point to the desired maximum temperature.
- From the Day mode, simultaneously press down the two buttons for more than 13 seconds, until the 🔒 icon appears.
- Release the buttons. The thermostat is now locked.

Procedures to deactivate the Security mode

- To deactivate the Security mode, start by cutting off the thermostat power at circuit breaker and wait at least 20 seconds.

2. Turn the thermostat power back on and the  icon will blink for a maximum of 5 minutes.
3. Simultaneously press down both buttons for 13 seconds (note that the backlight will blink after 3 seconds and the °C or °F symbol will appear after 8 seconds, but continue to keep both buttons pressed down). After 13 seconds, the  icon will disappear and the degrees symbol (C or F) will stop blinking, indicating that the Security mode is deactivated. Release the buttons.

Long cycle/Short cycle mode

The Long/Short cycle activation is similar to the Celsius/Fahrenheit degrees adjustment. To switch from long cycle heating (15 minutes, ideal for a heater with fan) to a short cycle heating (15 seconds, ideal for a convection heater without fan), you must simultaneously press down both buttons during 8 seconds in Day mode. After 8 seconds, the C or F icon will blink. Release the buttons. The screen then displays CC to indicate short cycle or CL to indicate the long cycle. To switch from one mode to the other, press down the bottom button. Once the adjustment done, exit this mode by not pressing down any button for 5 seconds.

Minimum ON/OFF time selection in Long cycle

In Long cycle, you can adjust the minimum ON/OFF time (e.g. the minimum time between the start and the shut down of the heating). First, activate the Long/Short cycle mode as described in the previous section. Press down the bottom button for 3 seconds until the time in seconds appears on the screen. Release the button. Adjust the minimum time from 90 to 405 seconds, by increments of 45 seconds (factory setting = 180 seconds). Please note that the Long cycle (CL) is automatically activated when we enter in the minimum ON/OFF time selection mode. Once the adjustment done, exit this mode by not pressing down any button for 5 seconds.

Parameters saving and power failures

The thermostat saves some parameters in a non-volatile memory to be able to recover them after being shut off (a power failure, for example). These parameters are the Day/Night settings, the Single programming mode, the state of the Security mode, the maximum symbol of the Security mode, the Celsius/Fahrenheit symbol, short or long cycle, the number of minutes associated to a heating cycle, the number of hours of the night time-switch, the number of hours

remaining on the night time-switch and the current Day/Night mode. These parameters are saved every minute if any changes are made, except for the Day/Night mode and the remaining time left on the time-switch. These are saved only if the Single programming mode had not been activated.

Please note that the Single programming mode is not automatically reactivated when the thermostat is turned on. The  icon blinks to warn the user that the mode was previously activated when the thermostat was shut off but is no longer active. Furthermore, when power is shut off, the existing Day/Night mode is recovered only if the Single programming mode was previously deactivated. In the opposite case, the Day mode is automatically reactivated. The Security mode is also reactivated if it was previously activated. However, the icon will blink for 5 minutes, during which it is possible to deactivate the Security mode by pressing down both buttons simultaneously for 13 seconds. If this is not done, the Security mode will remain activated and the icon will stop blinking.

Night light (only for model with backlight)

You can activate the Night light option to permanently turn on the backlight. To activate or deactivate this mode, the thermostat must first be set in Day mode. Then, simultaneously press down both buttons for 3 seconds until the backlight blinks. Release the buttons. The night light mode will be activated (or deactivated if it was previously activated).

PROBLEM	DEFECTIVE PART OR PART TO CHECK
Heating is always on	<ul style="list-style-type: none"> • Check if the thermostat is properly connected. Refer to the installation section.
Heating does not run even if the thermostat indicates it is on	<ul style="list-style-type: none"> • Check if the thermostat is properly connected. Refer to the installation section.
The display does not come on	<ul style="list-style-type: none"> • Check if the thermostat is properly connected. Refer to the installation section. Check the power supply at the electrical panel. Check if the heating unit has a switch. If so, ensure that this switch is turned on.
The displayed ambient temperature is incorrect	<ul style="list-style-type: none"> • Check the presence of an air stream or a heat source near the thermostat, and correct the situation.
The display indicates E1 or E2	<ul style="list-style-type: none"> • Faulty thermal sensor. Contact the customer service.
Weak luminosity of the display	<ul style="list-style-type: none"> • Possibility of a bad contact. Check thermostat wirings. Refer to the installation section.

If you are unable to solve the problem after having verified these points, please communicate with our customer service. Consult our website for the phone numbers.

Supply voltage:

24 VAC, 50/60 Hz

Maximum electrical current with a resistive load:

0.5 A

12 W @ 24 VAC

Temperature display range:

3 °C to 40 °C (37 °F to 99.5 °F)

Temperature display resolution:

0.5 °C (0.5 °F)

Temperature set point range:

3 °C to 30 °C (37 °F to 86 °F)

Temperature set point increments:

0.5 °C (1 °F)

Storage temperature:

-40 °C to 50 °C (-104 °F to 122 °F)

Inputs / outputs

A 3-positions connector is located at the back of the thermostat.

C: 24 VAC common

W: Load output

R: 24 VAC input

Compatible with Stepro electronic relays

LIMITED WARRANTY

This unit has a 3-year warranty. If at any time during this period the unit becomes defective, it must be returned to its place of purchase with the invoice copy, or simply contact our customer service department (with an invoice copy in hand). **In order for the warranty to be valid, the unit must have been installed and used according to instructions.** If the installer or the user modifies the unit, he will be held responsible for any damage resulting from this modification. The warranty is limited to the factory repair or the replacement of the unit, and does not cover the cost of disconnection, transport, and installation.

E-mail: contact@stelpro.com

Web site: www.stelpro.com