

FAN GUARD TOP VIEW (2X)

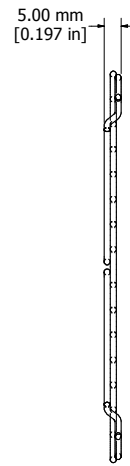

FAN GUARD SIDE VIEW

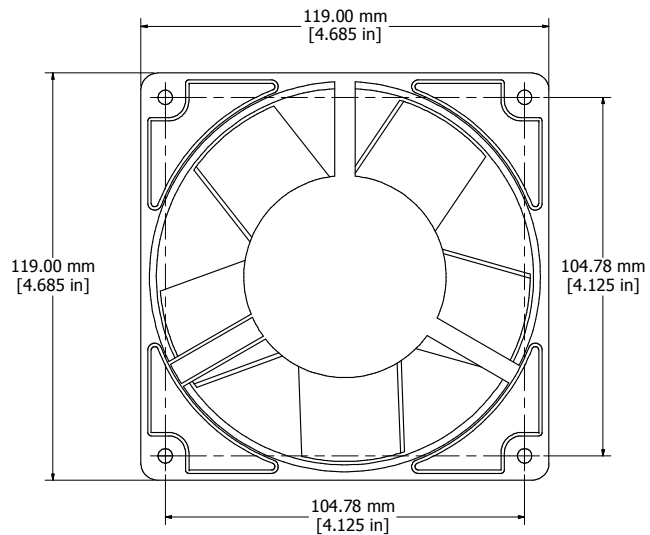

FAN TOP VIEW (1X)

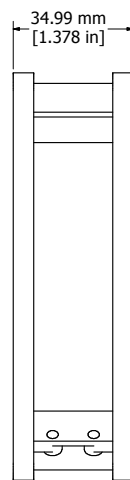

FAN SIDE VIEW

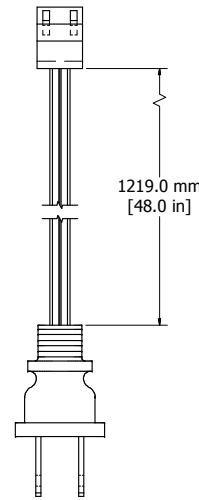

NEMA 1-15P 48" CORD (1X)

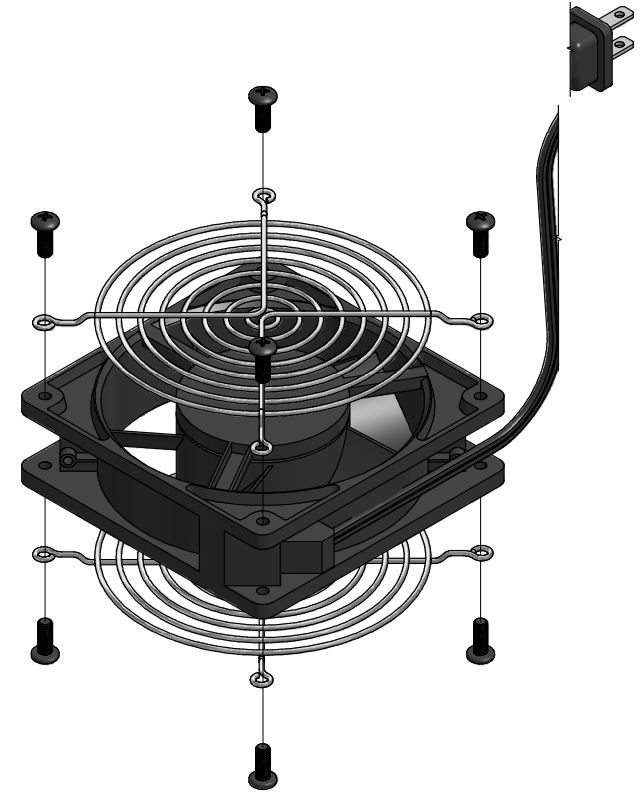

EXPLODED ASSEMBLY VIEW

DNFK1AC120
Guard Material/Finish - Chrome Plated Steel
Fan Rating - 115 VAC, 50/60 Hz, 0.38 Amps, 100 CFM
Hardware
8 Screws - #10-32 x 1/2" Panhead



**HAMMOND
MANUFACTURING™**

DNFK1AC120

www.hammondmfg.com