

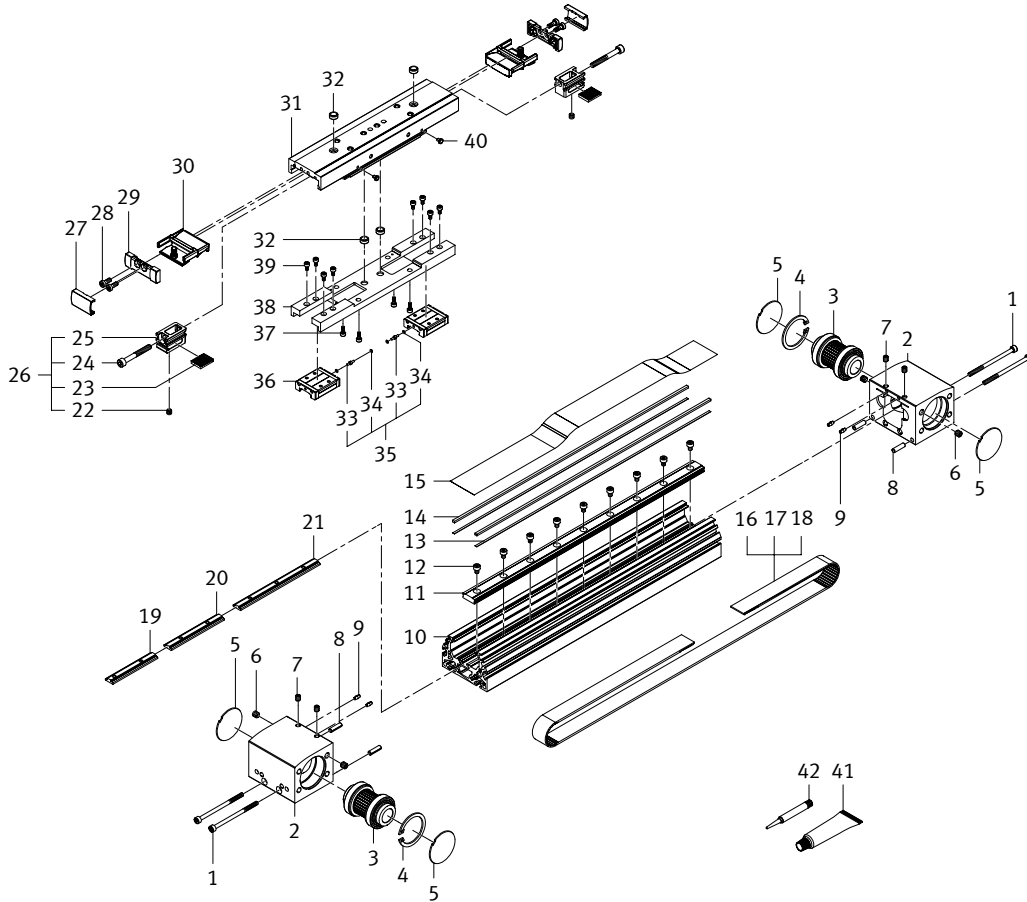



































8041860 ELGA-TB-KF-80-600-0H Toothed belt axis - Series: All



8041860 ELGA-TB-KF-80-600-0H Toothed belt axis - Series: All

→ Display in the catalog
→ Spare parts catalog
→ 3D View

Pos.	Part no.	Type	Note	Qty.	Unit	
1	200681	ISO 4762-M5X70-8.8 Socket head screw	Tightening torque 5 Nm / 3.7 lbf ft Use thread locking agent. See position no. 42	4	Pc	
2	3216950	ELGA-TB-80 Drive cover	Attention, please order position 6 as well	1	Pc	
3	1124565	ELGA-TB-G-80 Toothed belt pulley module		1	Pc	
4	771487	DIN 472-47X1,75 Retaining ring		1	Pc	
5	2493424	ELGA-TB-RF-80-F1: Ø48 Sealing washer		4	Pc	
6	204495	ISO 4028-M6X8-45H Threaded pin	Use thread locking agent. See position no. 42	2	Pc	
7	204495	ISO 4028-M6X8-45H Threaded pin	Tightening torque 2 Nm / 1.5 lbf ft	4	Pc	
8	349184	DIN 7346-4,5X16 Spring pin		2	Pc	
9	686823	DGSL-8-PJ Buffer element		2	Pc	
10		ELGA-TB-KF-80 Cylinder barrel	Not available	1	Pc	
11		ELGA-TB-KF-80 Roller track	Not available	1	Pc	
12	8030874	ISO 4762-M4X7-12.9 Socket head screw	Tightening torque 4.5 Nm / 3.3 lbf ft Use thread locking agent. See position no. 42	1	Pc	
13	4171246	ELGA-TB-KF Adhesive tape		25	m	
14	8040752	2X3X10000 Magnetic tape		10	m	
15	8040745	ELGA-YA-TB-KF-80- - Cover strip	When ordering please specify the configuration (see type plate)	1	Pc	
16	8040749	ELGA-YT-TB-KF-80- - Toothed belt	When ordering please specify the configuration (see type plate) Attention! It is essential that the information in the repair instructions be closely observed!	1	Pc	
17	8096938	30,3LL-5MR-5M-610-5555 Toothed belt	Attention! Length 5 meter Attention! The Material is []	1	Pc	
18	8119356	PGGT-30-LL-5MR-5M-PU2 Toothed belt	Attention! Length 5 meter Attention! The Material is [PU2]	1	Pc	
19	652565	DGEA- 18-.....ZR Slot nut		2	Pc	
20	652564	DGEA- 18-.....ZR Slot nut		1	Pc	
21	652563	DGEA- 18-.....ZR Slot nut		1	Pc	
22	369654	ISO 4026-M8X8-45H Threaded pin	Tightening torque 2 Nm / 1.5 lbf ft Use thread locking agent. See position no. 42	1	Pc	
23		EGC-120-TB Clamping plate	Not available separately, see position 26	1	Pc	
24		ISO 4762-M6X55-10.9 Socket head screw	Not available separately, see position 26	1	Pc	
25		ELGA-TB-G-80 Clamping part	Not available separately, see position 26	1	Pc	
26	1214923	ELGA-TB-G-80 Clamping		2	Pc	
27	1205680	ELGA-TB-G-80 Clip		2	Pc	

Pos.	Part no.	Type	Note	Qty.	Unit	
28	369843	DIN 6912-M4X10-8.8 Socket head screw	Tightening torque 1.2 Nm / 0.9 lbf ft Use thread locking agent. See position no. 42	4	Pc	
29	1205678	ELGA-TB-G-80 Cover		2	Pc	
30	1202754	ELGA-TB-G-80 Belt reversal		2	Pc	
31		ELGA-TB-KF-80 Slide module	No longer available. Please order from product series J5 the components with position nos. 31+40+41. Grease during re-assembly. See position no. 41	1	Pc	
32	8137184	ZBH-9-B Centring sleeve		4	Pc	
33		ELGA-TB-KF-70/80 Oil duct	Not available separately, see position 35	2	Pc	
34		B-1,5X1-N-NBR70 O-ring ISO3601	Not available separately, see position 35	4	Pc	
35	8049975	ELGA-...-KF-70/80 Oil duct		1	Pc	
36	716520	EGC-80-KF-GK/GV Roller carriage	Attention! It is essential that the information in the repair instructions be closely observed! Grease during re-assembly. See position no. 41	1	Pc	
37	200669	ISO 4762-M5X10-10.9 Socket head screw	Tightening torque 5.5 Nm / 4.1 lbf ft Use thread locking agent. See position no. 42	4	Pc	
38		ELGA-TB-KF-80 Connecting plate module	Not available	1	Pc	
39	723976	ISO 4762-M3X8-12.9 Socket head screw	Tightening torque 2 Nm / 1.5 lbf ft Use thread locking agent. See position no. 42	8	Pc	
40		D1 M3 Lubrication nipple	Not available Tightening torque 0.5 Nm / 0.4 lbf ft	2	Pc	
41	684474	LUB-KC1 SILIKONFREI 20ML Lubricating grease		1	Pc	
42	8181256	CYBERBOND TM44 TB1ML Adhesive bonding agent		1	Pc	