

# SCOUT 4548

PROJECT PROJÉT
SPEC TYPE
NOTES



## FINISH FINI



BLKE WHE LGE PGE NBE RDP

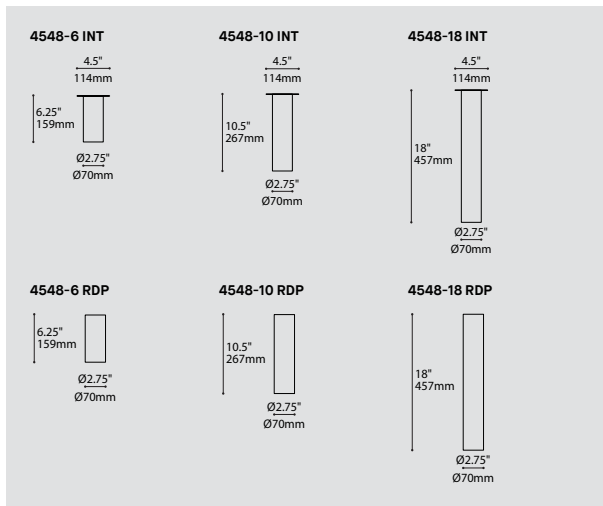

## PRODUCT CHARACTERISTICS CARACTÉRISTIQUES DU PRODUIT



CERTIFIED: c-CSA-us

## ORDERING SPECIFICATION SPÉCIFICATION DE COMMANDE

MODEL MODÈLE	CODE
4548-6 SCOUT 6"	
4548-10 SCOUT 10"	
4548-18 SCOUT 18"	
LIGHT SOURCE SOURCE LUMINEUSE	
LED REGULAR OUTPUT	
LED.HO HIGH OUTPUT	
COLOR TEMPERATURE TEMPÉRATURE DE COULEUR	
27* 2700K	
30 3000K	
35 3500K	
40 4000K	
* LONGER LEAD TIME MAY APPLY, PLEASE CONTACT YOUR EUREKA REPRESENTATIVE	
COLOR RENDERING INDEX (CRI) INDICE DE RENDU DE COULEUR (IRC)	
80 80+ CRI	
90* 90+ CRI	
* LONGER LEAD TIME MAY APPLY, PLEASE CONTACT YOUR EUREKA REPRESENTATIVE	
VOLTAGE VOLTAGE	
120V 120 VOLT	
277V 277 VOLT	
CONTROL OPTION OPTION DE CONTRÔLE	
DV 0-10V DIMMING (120V-277V)	
DP PHASE DIMMING (120V ONLY)	
NLTAIR2* NLIGHT AIR CONTROL GEN 2	
NLIGHT* NLIGHT WIRED CONTROL	
* NLIGHT INTEGRATION REQUIRES A REMOTE POWER PACK (39NLAB FOR NLTAIR2 OR 39NLWB FOR NLIGHT).	
* EMERGENCY BATTERY NOT AVAILABLE WITH NLIGHT OPTIONS	
REFER TO NLIGHT GUIDE AND INSTALLATION SHEET FOR ALL REQUIREMENTS.	
EMERGENCY BATTERY BATTERIE D'URGENCE	
FOR 120-277V, EM DRIVER BOX INCLUDED, INSTALLED REMOTELY. SEE EM GUIDE FOR DETAILS.	
EMB* EMERGENCY BATTERY FOR REMOTE BOX	
* 3981EA ACCESSORY IS REQUIRED	
BEAM ANGLE ANGLE DE FAISCEAU	
NA NARROW (24°)	
ME MEDIUM (45°)	
OPTICAL ACCESSORIES ACCESSOIRES OPTIQUES	
CLR CLEAR GLASS LENS	
FRO FROSTED GLASS LENS	
HON HONEYCOMB LOUVER	
SOL SOLITE SOFTENING LENS	
DRIVER & CANOPY OPTION OPTION DE PILOTE & PAVILLON	
INT* INTERNAL DRIVER, WITH FLAT CANOPY	
RDP** RECESSED DRIVER, NO CANOPY	
* FOR 4548-6, DRIVER WILL BE IN DEEP JUNCTION BOX	
**RDP OPTION IS NOT OFFERED WITH NLIGHT CONTROL OPTION	
CANOPY FINISH FINI PAVILLON <sup>(A)</sup>	
WHE* WHITE FINE TEXTURE	
* IF NO FINISH IS SELECTED, FLAT CANOPY FINISH WILL BE THE SAME AS STRUCTURE FINISH	
<sup>(A)</sup> FILL IN IF INT DRIVER & CANOPY OPTION AND WHE FINISH IS SELECTED, OTHERWISE LEAVE EMPTY	
CYLINDER FINISH FINI CYLINDRE	
BLKE BLACK FINE TEXTURE	
WHE WHITE FINE TEXTURE	
LGE LIGHT GREY FINE TEXTURE	
PGE PALE GREEN FINE TEXTURE	
NBE NAVY BLUE FINE TEXTURE	
RAL* PLEASE SPECIFY RAL CODE	
* LONGER LEAD TIME MAY APPLY, PLEASE CONTACT YOUR EUREKA REPRESENTATIVE	
BAFFLE FINISH FINI DÉFLECTEUR	
BLKE BLACK FINE TEXTURE	
WHE WHITE FINE TEXTURE	
ACCESSORY ACCESSOIRE	
3983 DEEP JUNCTION BOX (PROVIDED FOR 4548-6 WITH INT OPTION)	
39NLAA* NLIGHT AIR GEN 2 REMOTE POWER PACK	
39NLWA* NLIGHT WIRED REMOTE POWER PACK	
* FOR CHICAGO PLENUM INSTALLATION, PLEASE CONTACT YOUR EUREKA REPRESENTATIVE .	
EMERGENCY BATTERY ACCESSORY ACCESSOIRE BATTERIE D'URGENCE	
3981EA ELECTRICAL BOX FOR EMB EMERGENCY BATTERY	

# SCOUT 4548

QUICKSHIP

PROJECT PROJET

SPEC TYPE

NOTES



FINISH FINI

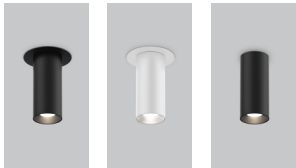

BLKE

WHE

RDP

4548-6 INT

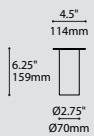

4548-10 INT

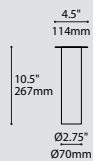

4548-18 INT



4548-6 RDP

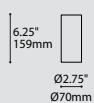

4548-10 RDP

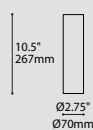

4548-18 RDP

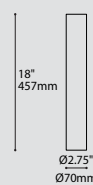

ORDERING SPECIFICATION SPÉCIFICATION DE COMMANDE

CODE

QUICKSHIP

QS5 QUICKSHIP 5 DAYS - MAXIMUM 5 UNITS QUICKSHIP 5 JOURS - MAXIMUM 5 UNITÉS  
QS10 QUICKSHIP 10 DAYS - MAXIMUM 20 UNITS QUICKSHIP 10 JOURS - MAXIMUM 20 UNITÉS

MODEL MODÈLE

4548-6 SCOUT 6"  
4548-10 SCOUT 10"  
4548-18 SCOUT 18"

LIGHT SOURCE SOURCE LUMINEUSE

LED REGULAR OUTPUT  
LED.HO HIGH OUTPUT

COLOR TEMPERATURE TEMPÉRATURE DE COULEUR

30 3000K  
35 3500K  
40 4000K

COLOR RENDERING INDEX (CRI) INDICE DE RENDU DE COULEUR (IRC)

80 80+ CRI

80

VOLTAGE VOLTAGE

120V 120 VOLT  
277V 277 VOLT

DIMMING OPTION OPTION DE GRADATION

DV 0-10V DIMMING (120V-277V)  
DP PHASE DIMMING (120V ONLY)  
LED DIMMING DRIVER IS STANDARD IN THIS PRODUCT. PLEASE SPECIFY YOUR DIMMING TYPE

BEAM ANGLE ANGLE DE FAISCEAU

NA NARROW (24°)  
ME MEDIUM (45°)

OPTICAL ACCESSORIES ACCESSOIRES OPTIQUES

CLR CLEAR GLASS LENS  
FRO FROSTED GLASS LENS  
HON HONEYCOMB LOUVER  
SOL SOLITE SOFTENING LENS

DRIVER & CANOPY OPTION OPTION DE PILOTE & PAVILLON

INT\* INTERNAL DRIVER, WITH FLAT CANOPY  
RDP RECESSED DRIVER, NO CANOPY  
\*FOR 4548-6, DRIVER WILL BE IN DEEP JUNCTION BOX

CANOPY FINISH FINI PAVILLON (A)

WHE\* WHITE FINE TEXTURE  
\*IF NO FINISH IS SELECTED, FLAT CANOPY FINISH WILL BE THE SAME AS STRUCTURE FINISH  
(A) FILL IN IF INT DRIVER & CANOPY OPTION AND WHE FINISH IS SELECTED, OTHERWISE LEAVE EMPTY

CYLINDER FINISH FINI CYLINDRE

BLKE BLACK FINE TEXTURE  
WHE WHITE FINE TEXTURE

BAFFLE FINISH FINI DÉFLECTEUR

BLKE BLACK FINE TEXTURE  
WHE WHITE FINE TEXTURE

ACCESSORY ACCESSOIRE

3983 DEEP JUNCTION BOX (PROVIDED FOR 4548-6 WITH INT OPTION)

PRODUCT CHARACTERISTICS CARACTÉRISTIQUES DU PRODUIT



CERTIFIED: c-CSA-us

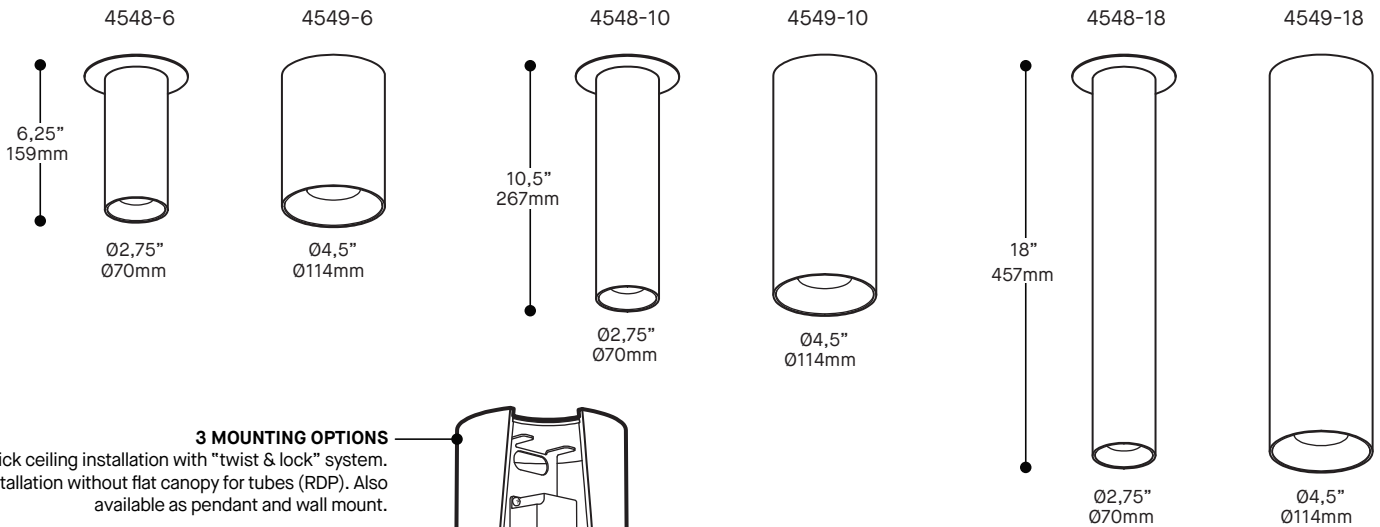

**3 MOUNTING OPTIONS**  
Quick ceiling installation with "twist & lock" system. Installation without flat canopy for tubes (RDP). Also available as pendant and wall mount.

**6 FORMATS & 5 FINISHES**  
Machined aluminium cylindrical structure, offered in textured black, white, light gray, navy blue or pale green finish.

**2 BAFFLE FINISHES**  
White or black, two options to fit your needs.

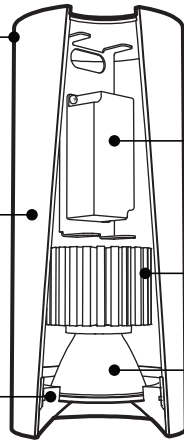

**2 DIMMING TYPE**  
Standard phase dimming (DP) or 0-10V dimming (DV). Integrated LED driver (454x-10 et 454x-18). Deep junction box (3983) included (454x-6).

**2 OUTPUTS & 3 CCT**  
Extruded aluminium heatsink designed to efficiently offer regular and high output.

**REFLECTORS & 3 OPTICAL ACCESSORIES**  
Narrow, medium or wide (xx49 only) beam angle reflector. Choice of optical accessories : clear lens, frosted lens or honeycomb louver.

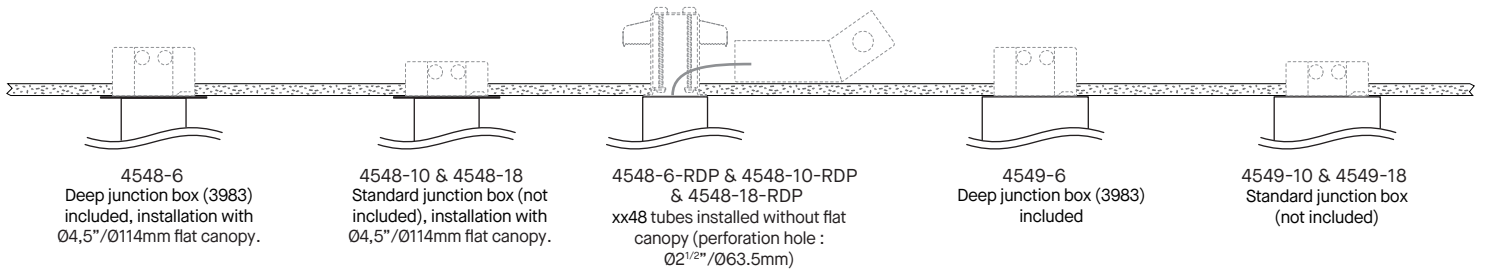

PRODUCT SPECIFICATION	XX48-NA		XX48-ME		XX49-NA		XX49-ME		XX49-WI	
	REG	HO	REG	HO	REG	HO	REG	HO	REG	HO
<b>PERFORMANCE</b>										
<b>SYSTEM WATTAGE</b>	9.5W	13.6W	9.5W	13.6W	13.7W	20W	13.7W	20W	13.7W	20W
<b>DELIVERED LUMENS (4000K)</b>	1051 LM	1425 LM	1051 LM	1425 LM	1394 LM	1907 LM	1509 LM	2070 LM	1472 LM	2021 LM
<b>EFFICACY</b>	110.6LM/W	104.7LM/W	110.6LM/W	104.7LM/W	101.7LM/W	95.4LM/W	110.1M/W	103.5LM/W	107.4M/W	101LM/W
<b>OTHER INFORMATIONS</b>										
<b>BEAM ANGLE</b>	24°		45°		28°		48°		64°	
<b>LUMINAIRE'S WEIGHT</b>	1.19KG / 1.38KG / 1.71KG 2.61LBS/ 3.03LBS/ 3.77LBS		1.19KG / 1.38KG / 1.71KG 2.61LBS/ 3.03LBS/ 3.77LBS		1.62KG / 1.99KG / 2.50KG 3.57LBS/ 4.37LBS/ 5.50LBS		1.62KG / 1.99KG / 2.50KG 3.57LBS/ 4.37LBS/ 5.50LBS		1.62KG / 1.99KG / 2.50KG 3.57LBS/ 4.37LBS/ 5.50LBS	
<b>L70 (LUMEN MAINTENANCE)</b>	> 63 600 HRS		> 63 600 HRS		> 63 600 HRS		> 63 600 HRS		> 63 600 HRS	

**EFFICACY MULTIPLIERS**

CRI	CCT	FACTOR
80+	4000K	1.0
80+	3500K	0.99
80+	3000K	0.97
80+	2700K	0.94
90+	4000K	0.89
90+	3500K	0.86
90+	3000K	0.84
90+	2700K	0.80

**LIGHT DISTRIBUTION**

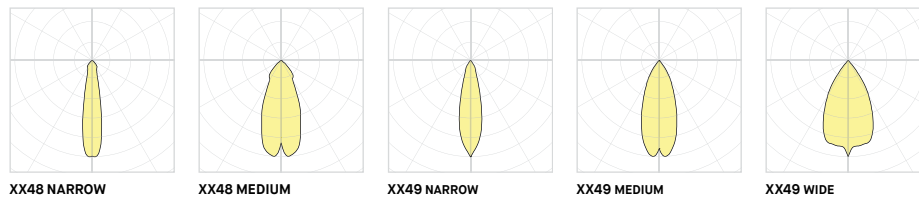

Visit our website for warranty terms and conditions.