

PRODUCT CODE: RTFFR4-101-CD-WH

4 INCH APERTURE DISK LIGHT SURFACE MOUNT - 3CCT

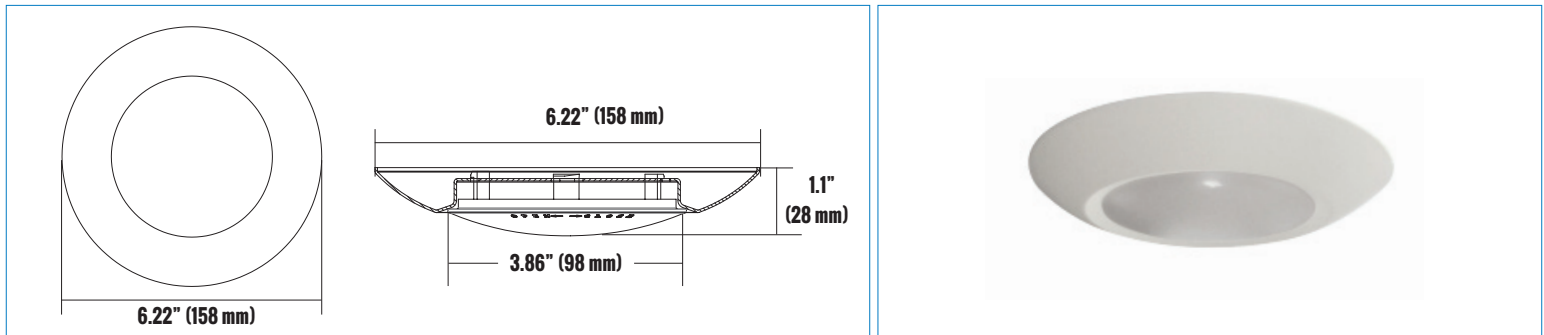

## PRODUCT DESCRIPTION

The Etlin-Daniels Low profile LED Surface Mount Disk Light RTFFR4-101-CD-WH offers the latest in both energy savings and ease of installation. At only 1.1" in depth and 6.2 inches in width, and with its easily removable translucent white polycarbonate diffuser, the RTFFR series provides a 105° beam pattern of glare free, energy efficient illumination.

The keyless slot rear mounting profile allows for a simple and quick installation in minutes. Triac dimmable and wet location rated, indoor applications include a wide range from closets and storage areas, basements, stairwells, to general lighting in small rooms. Take advantage of the 3CCT switch to choose between 3000K, 4000K and 5000K. And, for extra energy savings, take advantage of the available Triac dimming.

## FEATURES

- Indoor LED Light Source
- Surface mount, low profile - 1.1" housing with 105° translucent polycarbonate diffuser
- Keyless slot mounting to j-boxes
- Wet location and IC rated
- Triac Dimmable
- 3CCT - 3000K, 4000K, 5000K
- 5 year warranty
- L70 - 50,000 hours
- Energy Star Certified

## PRODUCT SPECIFICATIONS (OPTICAL DATA)

LED TYPE	LED QTY	SYSTEM EFFICACY	LUMENS	COLOR TEMPERATURE	BEAM ANGLE	CRI	SYSTEM EFFICIENCY	VOLTAGE	POWER FREQ.	POWER EFFICIENCY	POWER FACTOR	HARMONIC DISTORTION
DOB	28 CHIPS	60LM/W	581 LM 678 LM 602 LM	3000K 4000K 5000K	120°	>80CRI	>65%	120V	60HZ	>65%	>0.9	<50%

## PRODUCT SPECIFICATIONS

WATTAGE	FIXTURE MATERIAL	INGRESS PROTECT	LIFE SPAN	STORAGE TEMP	OPERATING TEMP	PRODUCT DIMENSIONS	CARTON SIZE
10W	ALUMINUM /PLASTIC	IP44	>50,000 HOURS	-5°C - 30°C -4°F - 22°F	-20°C - 40°C -4°F - 104°F	6.22 X 1.1 INCHES (158 X 28 MM)	13.75 X 8.88 X 14 INCHES (349 X 226 X 356 MM)

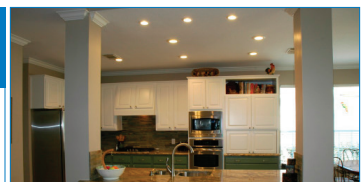

## ADDITIONAL INFORMATION

INSTALLATION METHOD

SURFACE MOUNT

FIXTURE COLOR

WHITE ALUMINUM/  
POLYCARBONATE DIFFUSER

CONTROL TYPE

TRIAC DIMMABLE

CATALOG #		TYPE
PROJECT		DATE
PREPARED BY		

**PRODUCT CODE: RTFFR4-101-CD-WH**
**4 INCH APERTURE DISK LIGHT SURFACE MOUNT - 3CCT**

**LUMINAIRE PHOTOMETRIC (TEST REPORT) - 3000K**
**ILLUMINANCE (AT A DISTANCE) - FLUX OUT: 406.2 LM**

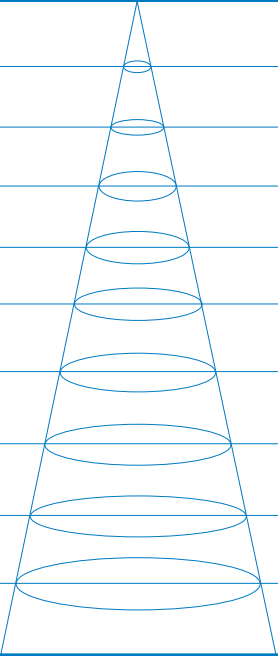
3.28FT 1M	63.40, 205.0 LX		9.32FT 284.31CM
6.56FT 2M	15.85, 51.26 LX		18.65 FT 568.61CM
9.84FT 3M	7.044, 22.78 LX		27.98FT 852.92CM
13.12FT 4M	3.962, 12.81 LX		37.31FT 1137.22CM
16.40FT 5M	2.536, 8.201 LX		46.64FT 1421.53 CM
19.69FT 6M	1.761, 5.695 LX		50.22FT 1530.84 CM
22.97FT 7M	1.294, 4.184 LX		65.29FT 1990.14 CM
26.25FT 8M	0.9906, 3.204 LX		74.62 FT 2274.45 CM
29.52FT 9M	0.7827, 2.531LX		83.95FT 2558.76 CM
32.80FT 10M	0.6340, 2.050 LX		92.98FT 2834.06CM
<b>HT</b>	<b>EAVG/EMAX</b>	<b>ANGLE: 109.75 DEG</b>	<b>DIA</b>

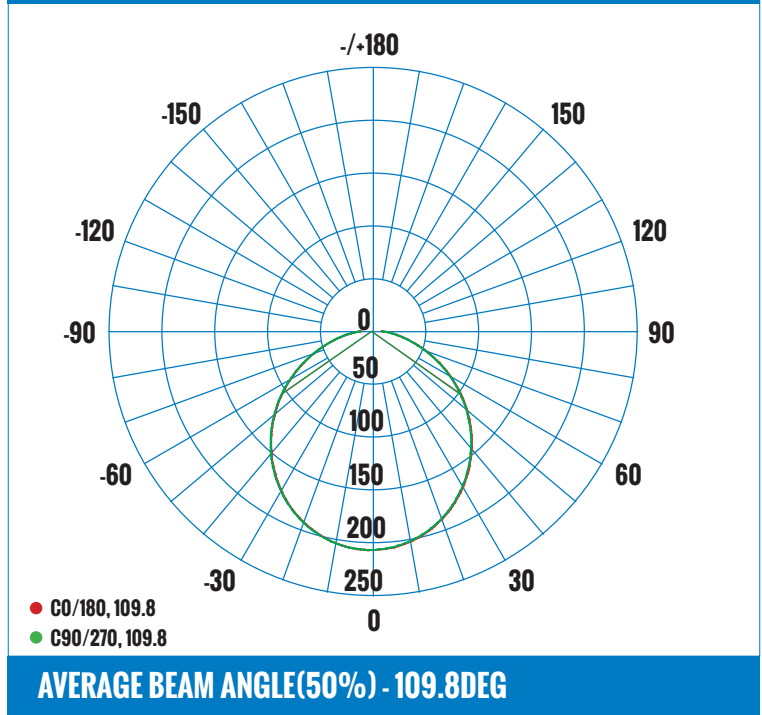
**LUMINOUS INTENSITY DISTRIBUTION DIAGRAM**

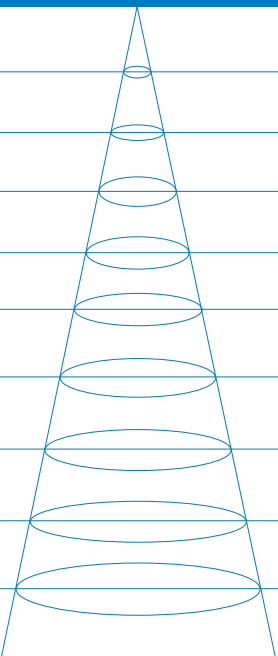
**LUMINAIRE PHOTOMETRIC (TEST REPORT) - 4000K**
**ILLUMINANCE (AT A DISTANCE) - FLUX OUT: 474.4LM**

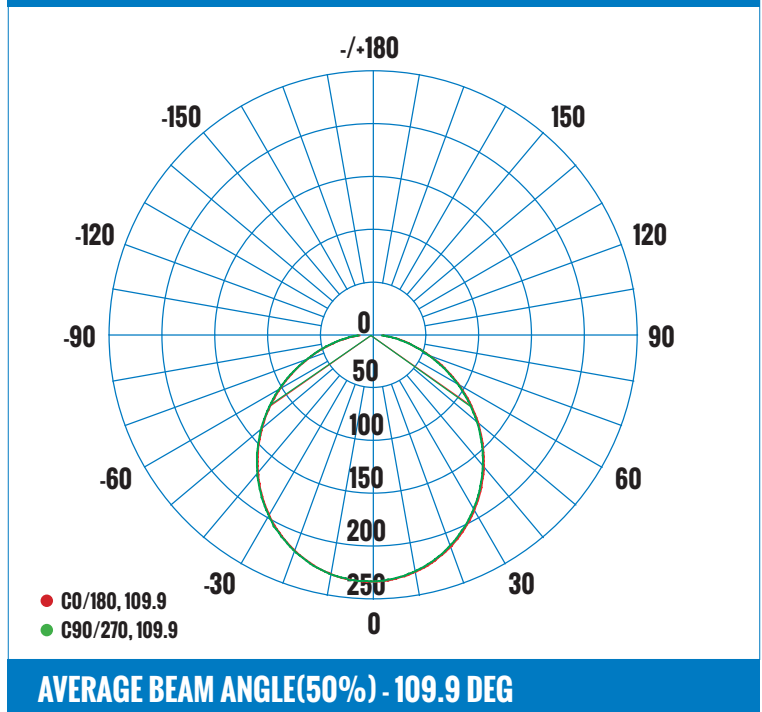
3.28FT 1M	74.03, 238.9 LX		9.34FT 284.83CM
6.56FT 2M	18.51, 59.72 LX		18.69FT 569.67CM
9.84FT 3M	8.225, 26.54 LX		28.03FT 854.50 CM
13.12FT 4M	4.627, 14.93 LX		37.38FT 1139.34 CM
16.40FT 5M	2.961, 9.555 LX		46.72FT 1424.17 CM
19.69FT 6M	2.056, 6.636LX		56.07FT 1709.00 CM
22.97FT 7M	1.511, 4.875 LX		65.41FT 1993.84 CM
26.25FT 8M	1.157, 3.733 LX		74.76FT 2278.67 CM
29.52FT 9M	0.9139, 2.949 LX		84.10FT 2563.51 CM
32.80FT 10M	0.7403, 2.389 LX		93.44FT 2848.34 CM
<b>HT</b>	<b>EAVG/EMAX</b>	<b>ANGLE: 109.85DEG</b>	<b>DIA</b>

**LUMINOUS INTENSITY DISTRIBUTION DIAGRAM**

CATALOG #		TYPE
PROJECT		DATE
PREPARED BY		

**PRODUCT CODE: RTFFR4-101-CD-WH**

**4 INCH APERTURE DISK LIGHT SURFACE MOUNT - 3CCT**



**LUMINAIRE PHOTOMETRIC (TEST REPORT) - 5000K**

**ILLUMINANCE (AT A DISTANCE) - FLUX OUT: 421.3LM**

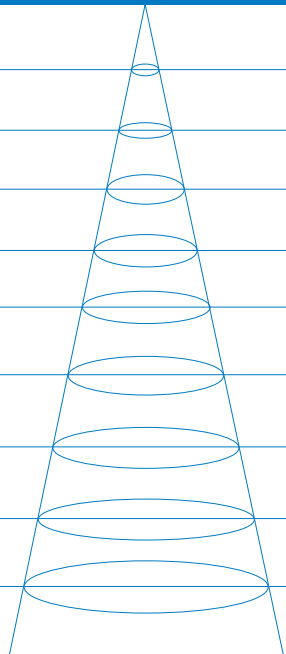
3.28FT 1M	65.75, 212.0 LX		9.35FT 284.99 CM
6.56FT 2M	16.44, 52.99 LX		18.70FT 569.99 CM
9.84FT 3M	7.305, 23.55 LX		28.05FT 854.98 CM
13.12FT 4M	4.109, 13.251 LX		37.40FT 1139.97 CM
16.40FT 5M	2.630, 8.478 LX		46.75FT 1424.96 CM
19.69FT 6M	1.826, 5.888 LX		56.10FT 1709.96 CM
22.97FT 7M	1.342, 4.326 LX		65.45FT 1994.95 CM
26.25FT 8M	1.027, 3.312 LX		74.80FT 2279.94 CM
29.52FT 9M	0.8117, 2.617 LX		84.15FT 2564.93 CM
32.80FT 10M	0.6575, 2.120 LX		93.50FT 2849.93 CM
<b>HT</b>	<b>EAVG/EMAX</b>	<b>ANGLE: 109.88DEG</b>	<b>DIA</b>

**LUMINOUS INTENSITY DISTRIBUTION DIAGRAM**

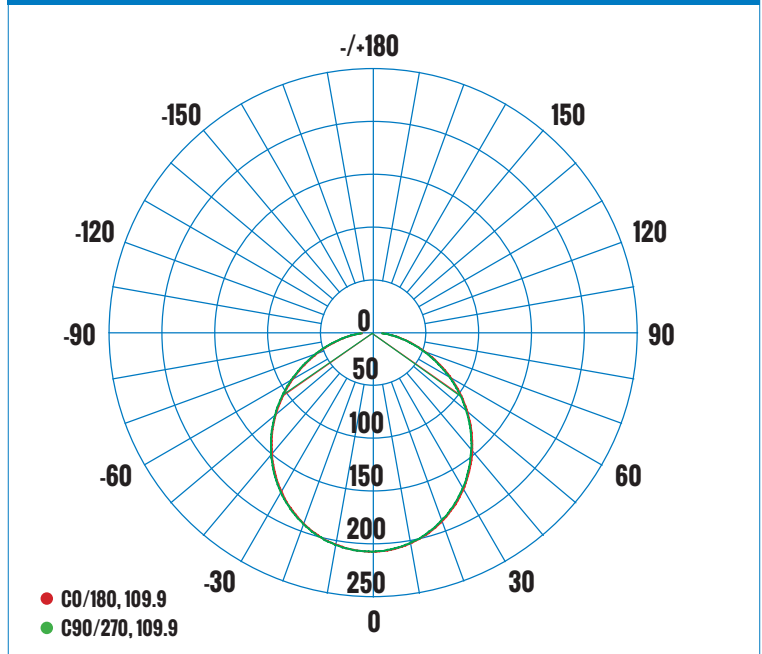

**AVERAGE BEAM ANGLE(50%) - 109.9 DEG**

**CERTIFICATIONS**



**CAN ICES-005 (B) / NMB-005 (B)**

**DRIVER/LED CHIP**



**ORDERING INFORMATION - RTFFR SERIES**

SHAPE	STYLE	SIZE	WATTAGE	VOLTAGE	COLOR TEMPERATURE	DIMMABLE	FINISH
E.G. R	TFFR	4	10	1	C	D	WH
R - ROUND	TFFR - THIN FLUSH FIXTURE REVEAL	4 - 4"	10- 10W	1 - 120V	C - CHANGEABLE COLOR TEMPERATURE 3000K, 4000K, 5000K	D - TRIAC	WH - WHITE

Head Office - 1850 Wilson Ave. · Toronto, ON · M9M 1A1 · Tel: 416.741.7336 · Fax: 416.741.9104

Toll Free: in Canada. 1.800.661.9610 · in USA. 1.888.762.5384 (SOCKETS4U)

www.etlin-daniels.com · For sales/service questions - sales@etlin.com