





Connection element, with end cover, black, for floor/angle mounting, with spring-type terminal,



product brand name	SIRIUS		
product designation	Connection element		
design of the product	for floor and bracket mounting,		
General technical data			
reference code according to EN 61346-2	X		
Enclosure			
height	42.5 mm		
width	70 mm		
outer diameter of the signal column element	70 mm		
material	PA		
color	black		
fastening method	Floor/bracket mounting		
protection class IP	IP65		
type of electrical connection	spring-loaded terminals		
Ambient conditions			
ambient temperature during operation	-20 ... +50 °C		
Certificates/ approvals			
General Product Approval	EMC	Declaration of Conformity	
Confirmation	 UL		 RCM
			 EG-Konf.
other			
Confirmation			
Further information			
Information- and Downloadcenter (Catalogs, Brochures,...) https://www.siemens.com/ic10			
Industry Mall (Online ordering system) https://mall.industry.siemens.com/mall/en/en/Catalog/product?mlfb=8WD4408-0AE			
Cax online generator http://support.automation.siemens.com/WWW/CAXorder/default.aspx?lang=en&mlfb=8WD4408-0AE			
Service&Support (Manuals, Certificates, Characteristics, FAQs,...)			

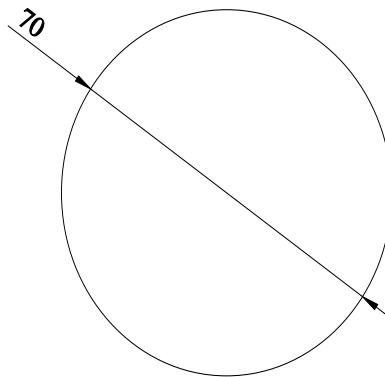
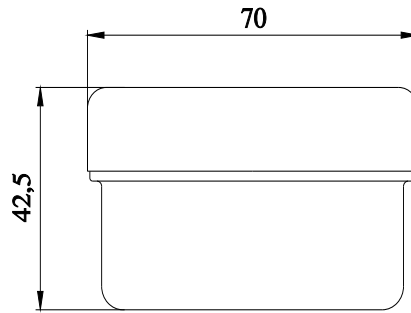

Standard

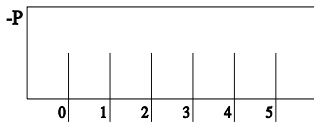

ASI

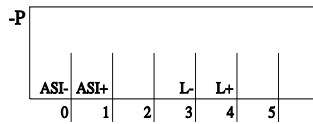

IO-Link

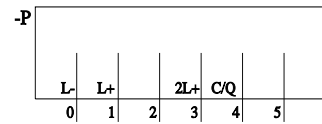

last modified:

12/23/2020 