



J

PMA® - Flexible cable protection systems



—
J

PMA - Flexible cable protection systems

Table of contents

Section J

Introduction	J4
PMA conduit	J8
PMAFIX Pro	J34
PMAFIX IP66, IP68 (IP69)	J46
Special connectors	J88
Accessories	J92
PMA JUMBO sizes	J112
PMA Divisible System	J120
PMA Smart Line IP66	J126
PMAJACK Plastic and metal braids	J134
Technical annex	J144
Further information	J155

Introduction

A swiss manufacturer with a global presence

There is no better reference than satisfied customers. PMA cable protection provides customized specific solutions for customers worldwide.

ABB's PMA manufacturing site is located in Uster (Switzerland), close to Zurich. The majority of what we produce for the world market is made at this location. Also our research and development department is located here.

Thanks of our large network of professional partners in all of the major industrialised countries around the globe, we are able to guarantee best quality regarding products, technical support, service and fast delivery.

ABB is focused on providing solutions that address the critical issues in every area of operations, allowing customers to focus on plant sustainability, cost, quality, flexibility, safety and regulatory challenges.





Setting new standards and trends

Customer needs are a top priority at ABB, and we work every day to ensure all our customer requirements are met in our products. We offer cable protection solutions and services that are tailored to meet requirements in every type of application. Our range extends from basic items right up to the most demanding high-tech products. We can develop system solutions and special products that are designed to meet specific customer requirements. Our intensive research and development activities, which include the field of new materials, are a major reason why PMA products from ABB continues to set new standards and trends in the cable protection marketplace. These efforts together with excellent quality and service have helped us build up an outstanding reputation with leading corporations around the world.

From pioneer to market leader

ABB has been developing, producing, and selling top-quality PMA cable protection systems since 1975. Our high-quality Swiss products have rapidly earned us an excellent reputation worldwide and established us as the market leader. Our range of more than 6,500 products gives customers the protection they need in railway, mechanical engineering, and shipbuilding applications worldwide. PMA products are also the solution of choice in automation, building installations and other projects where power and data cables require dependable protection.

Unique benefits of PMA products from ABB.

Service to the customer is what motivates us.

In addition to series production, PMA can build fittings and conduit to meet individual requirements as a special service to our customers.

- A safe, reliable system that is easy to install
- Vibration-proof connections
- System connection strength
- Ingress protection conforming to recognized test methods
- High impact strength even at low temperatures
- High compression strength (peak load)
- Long-term reversed-bending resistance
- Good chemical resistance
- Fire protection (flammability and smoke generation)
- Good weather resistance
- Long wearing
- ...and much more

Introduction

Areas of applications



Mechanical engineering

A considerable number of PMA cable protection systems are used in mechanical engineering. A few examples illustrate how varied the range of mechanical engineering applications is. You will find our products in machine tools, packaging machines, printing machines, as well as heating, ventilation, conveyer, and filling systems. PMA products also make a vital contribution to the smooth operation of high voltage and emergency power systems, can production machinery and woodworking machines, etc. PMA cable protection solutions safeguard cables, wires and data links against heat, cold, tensile stress, pressure stress, and other external influences in the important mechanical engineering industry.

Rail vehicles/Rail infrastructure

PMA products from ABB have proven their dependability in railway construction projects around the world. This is the reason why large corporations including Siemens, Alstom, Bombardier, PESA, CSR/CNR, Deutsche Bahn, and SNCF have chosen us as supplier over a period of many years. Our special railway engineering product line provides protection and safety on signalling systems, couplings, trucks, and gangways, as well as roof, and underfloor equipment.

The range of applications is very extensive. PMA products contribute to the safe operation of trams, locomotives, freight cars, high-speed trains, and even roller coasters.

Worldwide recognitions

All PMA products are rigorously tried and tested to meet the demands of industry worldwide.

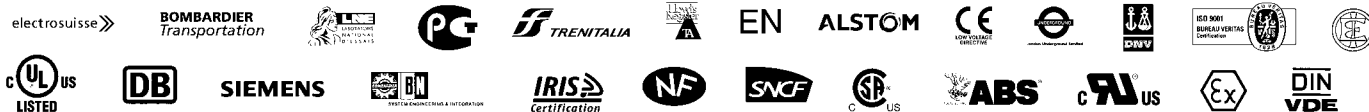



Automation/Robotics

In the field of automation, there is a need for products that can withstand the stress of motion-intensive applications. Solutions developed by ABB for the automation industry fully meet these requirements. Special conduit designs, supports and abrasion protection sleeves provide optimal protection along the entire length of all moving elements, enabling engineers to achieve a massive reduction in torsional forces. There is good reason why leading robotics manufacturers rely on ABB technology.















Countless applications

PMA cable protection products from ABB can be used in an extremely wide range of applications. The list is virtually endless and includes industries such as telecommunications, construction equipment and medical equipment. Wherever there is a need for cable protection, the PMA product portfolio provides safe, dependable, forward-looking solutions or will develop them specially for you to meet your individual needs.















PMA conduit

Conduit guide

Products			PMAFLEX Pro				PMAFLEX			
Application areas			PHT	PLU	POH	PSX	CYL	ESD	PCL	PCS
Machine building 	General applications	static					●		●	
		dynamic	●				●		●	●
	Heavy loads	static								
		dynamic								●
	Outdoor applications	static								●
		dynamic								●
	Antistatic requirements	static						●		
		dynamic						●		
Traction vehicles 	Outdoor applications with sunlight exposure	static							●	
		dynamic								●
	Outdoor applications	static	●							●
		dynamic	●							●
Indoor applications	static			●	●					
	dynamic									
Rail infrastructure 	Outdoor applications with sunlight exposure	static							●	
	Indoor and tunnel applications	static			●	●				
Automation/ Robotics 	Moving systems	dynamic	●				●	●	●	
	Systems with extreme movements	dynamic								
	Moving systems with antistatic requirements	dynamic						●		
Ship + Off-shore 	Outdoor general applications	static							●	
		dynamic	●							●
	Indoor applications	static					●		●	
		dynamic					●		●	●
Passenger area	static			●		●	●			
Energy 	Outdoor applications with sunlight exposure	static							●	
	Indoor applications	static			●		●	●		
	Exposed to radiation	static				●				
Food & Beverage 	General applications	static								
		dynamic								
Others     	Vehicle building	static	●							
	Telecommunications	indoor					●		●	
		outdoor								
	Building constructions	indoor				●				
		outdoor								
	Ex hazardous areas (ATEX, IECEx)	static						●		
High temperature applications	static	●			●					

PMA conduit

Conduit guide

Products		PMAFLEX Pro				PMAFLEX					
		PHT	PLU	POH	PSX	CYL	ESD	PCL	PCS		
Material properties	Ductility	■	■	■	■	■	■	■	■		
	Reversed bending resistance	■	■	■	■	■	■	■	■		
	Compression resistance	■	■	■	■	■	■	■	■		
	Low temperature performance	■	■	■	■	■	■	■	■		
	High temperature performance	■	■	■	■	■	■	■	■		
	Resistance to weathering	■	■	■	■	■	■	■	■		
	Approvals	 Bi-National Recognition File UL1696 & CSA C22.2 No. 227.3-05 Bi-National Listing File UL1660 & CSA C22.2 No. 227.2.1 Free from halogens, REACH + RoHS compliant Non flame propagating EN61386	  				●		●		
 EN 45545-2 NFPA 130 (ASTM E162 – ASTM E662) BSS 7239/SMP 800-C ASTM E1354 PN-K 2511 GOST 12.1.044-89		 		●							
 DNV (Type approved) Lloyd's Register (Type approved) Bureau Veritas (Type approved)		  		●		●		●	●		
Hazardous		ATEX									
		IECEX									
Food & Beverage		NSF									
		Ecolab									
Temperature range		Continuous operating temperature (acc. to DO 9.21-4510)	Min. (-)	-50	-25	-25	-100	-40	-40	-50	-50
			Max. (+)	135	95	95	170	105	90	105	95
		Short term max. operating temperature 168h (acc. to DO 9.21-4360)	(+)	180	120	120	200	160	150	160	150
Sizes	Nominal width min.		07	10	10	10	07	07	07	07	
	Nominal width max.		48	48	48	48	125	95	125	95	
	Metric size min.		10	12	12	12	10	10	10	10	
	Metric size max.		50	50	50	50	146	106	146	106	

PMAFLEX											PMAFLEX Multilayer			PMAFLEX Plus (UL-Listed)			Divisible System		PMA Smart Line											
PCSL	PEL	PIS/PIH	POS	PUE	PVD	VAM	VAML	VCS	VOH	PLR	XESX	XPCL	XR90	XSOL	XVCS1H	XVCS2H	XPCS	XPCSF	JFBD	CUS	PUS	VUS	PACOF	PPCOF	LLPA	LLPF				
■	■	■	■	■	■	■	■	■	■	■	■	■	■	■	■	■	■	■	■	■	■	■	■	■	■	■	■	■	■	■
■	■	■	■	■	■	■	■	■	■	■	■	■	■	■	■	■	■	■	■	■	■	■	■	■	■	■	■	■	■	■
■	■	■	■	■	■	■	■	■	■	■	■	■	■	■	■	■	■	■	■	■	■	■	■	■	■	■	■	■	■	■
■	■	■	■	■	■	■	■	■	■	■	■	■	■	■	■	■	■	■	■	■	■	■	■	■	■	■	■	■	■	■
■	■	■	■	■	■	■	■	■	■	■	■	■	■	■	■	■	■	■	■	■	■	■	■	■	■	■	■	■	■	■
■	■	■	■	■	■	■	■	■	■	■	■	■	■	■	■	■	■	■	■	■	■	■	■	■	■	■	■	■	■	■
●																													●	
●	●	●	●	●	●	●	●	●	●	●	●	●	●	●	●	●	●	●	●	●	●	●	●	●	●	●	●	●	●	●
●											●	●	●	●							●	●	●	●	●					
●																		●	●					●	●					
●																		●						●						
●		●																											●	●
●		●																											●	●
●		●																											●	●
											●																			
											●																			
																				●										
																				●										
-50	-50	-50	-25	-60	-40	-40	-40	-50	-40	-40	-50	-50	-40	-50	-50	-50	-40	-50	-18	-40	-50	-50	-40	-20	-40	-40				
95	60	95	95	50	150	105	105	105	105	105	90	105	95	95	90	90	95	95	90	105	95	105	105	105	105	105				
150	-	150	130	-	-	160	160	160	160	160	150	160	150	150	120	120	150	150	120	160	150	160	160	150	160	160				
07	10	07	07	17	10	10	10	07	07	07	10	12	17	12	12	12	10	10	12	17	17	17	07	07	07	07				
48	48	125	95	70	29	48	125	95	125	48	48	48	48	48	48	48	48	48	48	48	48	48	70	70	125	48				
10	12	10	10	20	12	12	12	10	10	10	12	16	20	16	16	16	12	12	16	20	20	20	10	10	10	10				
50	50	146	106	80	32	50	146	106	146	50	50	50	50	50	50	50	50	50	30	50	50	50	80	80	146	50				

Key
● correct

PMA conduit

Overview

Conduit to protect cables. We offer many different conduit types for diverse applications with various technical requirements.

—
01 **CXR90** Conduit
Three layer corrugated
conduit, very flexible,
medium-duty
(Multilayer)

—
02 **PHT** Conduit
Highly flexible, medium /
heavy-duty

The product groups:

- PMAFLEX Pro
- PMAFLEX
- PMAFLEX Plus
- PMAFLEX Multilayer
- PMA Divisible System
- PMA Smart Line

Offering many different conduit types for diverse applications with various technical requirements to protect humans and cables. Conduit sizes range from 6mm to 125mm Ø, from lightweight to heavyweight, and from pliable to highly flexible. PMA also offers slit and divisible conduit. Standard colours are black and grey.

Many conduit are specially approved, e.g. CSA, UL Recognition, DNV, Lloyds, Bureau Veritas etc. All conduit are REACH and RoHS compliant.



—
01

—
02

PMA CONDUIT

Offering many different conduit types for diverse applications with various technical requirements to protect humans and cables.

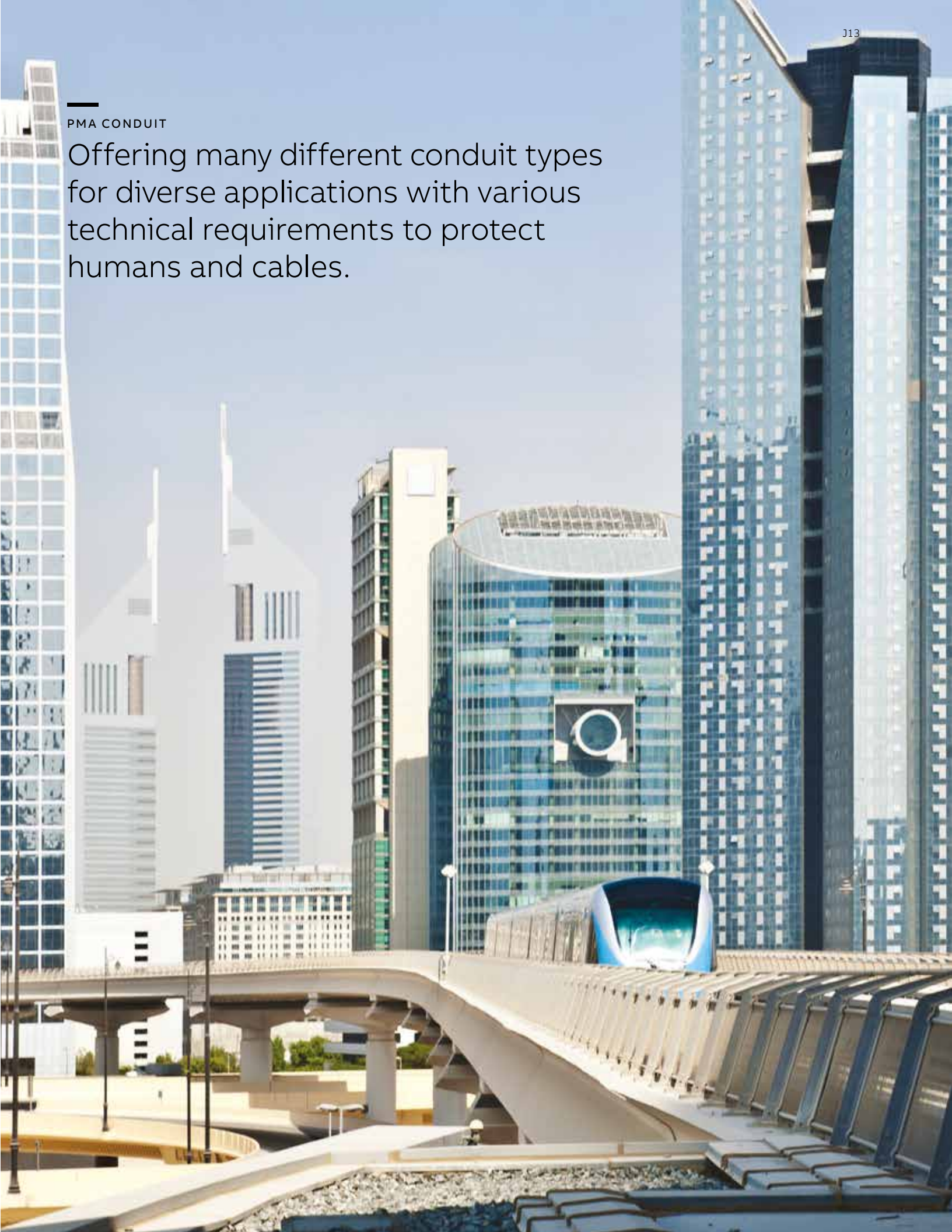

PMA conduit

Part number codes

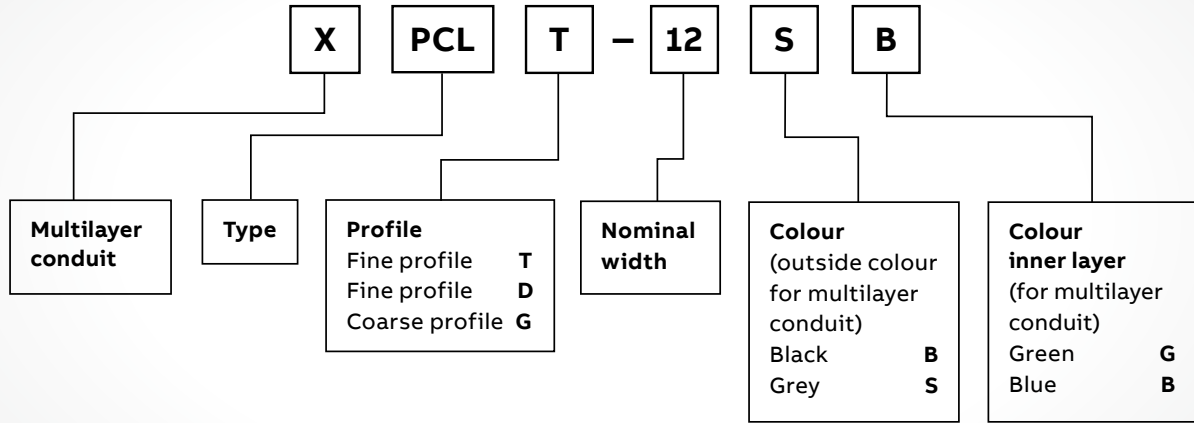

Radius

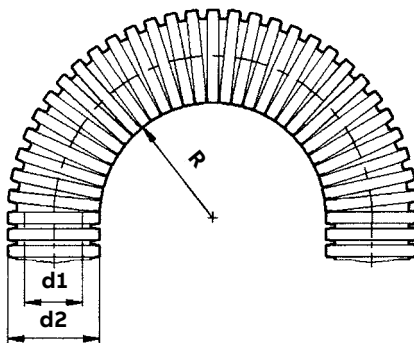

Stat. radius = Lowest recommended bending radius for static (fixed) installation.

Dyn. radius = Lowest recommended bending radius for dynamic (flexible) installation.

Profile

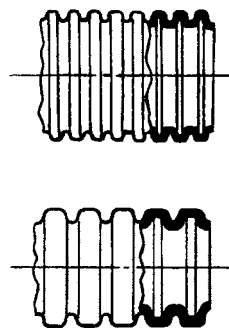

Fine profile T
Tight bending radius.

Coarse profile G
High pull-out strength.

PMAFLEX Pro

Type PHT & PLU conduit

Type PHT - Highly flexible, medium/heavy-duty

	Order no. (black)	Conduit size		Inside Ø (mm)	Outside Ø (mm)	Stat./Dyn. radius (mm)	PU (m)
		NW	Metric				
	PHTT-07B	07	10	6.2	10.0	15/40	50
	PHTT-10B	10	12	9.6	13.0	20/55	50
	PHTT-12B	12	16	12.0	15.8	30/65	50
	PHTT-17B	17	20	16.2	21.2	40/70	50
	PHTT-23B	23	25	22.6	28.5	45/95	50
	PHTG-17B	17	20	15.2	21.2	40/75	50
	PHTG-23B	23	25	22.0	28.5	45/100	50
	PHTG-29B	29	32	27.7	34.5	55/120	50
	PHTG-36B	36	40	35.8	42.5	60/180	30
	PHTG-48B	48	50	46.8	54.5	70/200	30

PHT Index

min.	max.
Ductility	
Fatigue reversed bending	
Compression resistance (PHTT-17B)	
Compression resistance (PHTG-17B)	
Low temperature performance	
Weathering resistance	

For applications at high and very low temperatures / dynamic applications
Specially formulated polyamide elastomer. Both excellent flexibility and high compression strength
Enhanced temperature range compared to standard polyamides
High resistance to ultra violet rays and weathering

Materials	Temperature range	Colour
Specially formulated polyamide elastomer	-50°C to +135°C	Black
Certification	Short-term to: +180°C	
Free from halogens, REACH compliant and RoHS compliant	Impact resistance	UV Resistance
	Extremely good at low temperatures	High

Type PLU - Flexible, medium-duty

	Order no. (black)	Conduit size		Inside Ø (mm)	Outside Ø (mm)	Stat. radius (mm)	PU (m)
		NW	Metric				
	PLUT-10B	10	12	9.5	13.0	20	50
	PLUT-12B	12	16	11.8	15.8	30	50
	PLUG-17B	17	20	15.3	21.2	40	50
	PLUG-23B	23	25	22.4	28.5	45	50
	PLUG-29B	29	32	28.7	34.5	55	50
	PLUG-36B	36	40	36.3	42.5	65	30
	PLUG-48B	48	50	47.3	54.5	70	30

PLU Index

min.	max.
Ductility	
Fatigue reversed bending	
Compression resistance	
Low temperature performance	
Weathering resistance	

For highest fire and passenger safety requirements
Excellent fire safety characteristics acc. to BS 6853 1a (interior) and LUL Engineering Standard,
approved by Metronet and Tube Line
For static interior applications
Good ductility

Materials	Temperature range	Colour
Specially modified polypropylene	-25°C to +95°C	Black
Certification	Short-term to: +120°C	
Free from halogens, REACH compliant and RoHS compliant	Impact resistance	UV Resistance
	Good impact resistance	-

PMAFLEX Pro

Type POH & PSX conduit

Type POH - Very flexible, medium-duty

	Order no. (black)	Order no. (grey)	Conduit size		Inside Ø (mm)	Outside Ø (mm)	Stat. radius (mm)	PU (m)
			NW	Metric				
	POHT-10B	POHT-10S	10	12	9.2	13.0	13.0	50
	POHT-12B	POHT-12S	12	16	11.8	15.8	15.8	50
	POHG-17B	POHG-17S	17	20	15.7	21.2	21.2	50
	POHG-23B	POHG-23S	23	25	22.0	28.5	28.5	50
	POHG-29B	POHG-29S	29	32	27.4	34.4	34.4	50
	POHG-36B	POHG-36S	36	40	35.8	42.4	42.4	30
	POHG-48B	POHG-48S	48	50	46.8	54.4	54.5	30

For highest fire and passenger safety requirements
 Excellent fire safety characteristics acc. to BS 6853 1a (interior)
 Good ductility and reversed bending characteristics

POH Index

min.	max.
Ductility	
Fatigue reversed bending	
Compression resistance	
Low temperature performance	
Weathering resistance	

Materials	Temperature range	Colour
Specially modified polypropylene	-25°C to +95°C	Black/Grey
Certification	Short-term to: +120°C	
Free from halogens, REACH compliant and RoHS compliant	Fire performance	UV Resistance
	acc. to BS 6853 1a (interior)	-

Type PSX - Flexible, light-duty

	Order no. (black)	Conduit size		Inside Ø (mm)	Outside Ø (mm)	Stat. radius (mm)	PU (m)
		NW	Metric				
	PSXT-10B	10	12	9.8	13.0	20	50
	PSXT-12B	12	16	12.2	15.8	30	50
	PSXT-17B	17	20	16.2	21.2	35	50
	PSXG-23B	23	25	22.3	28.5	45	50
	PSXG-29B	29	32	28.0	34.5	55	50
	PSXG-36B	36	40	36.5	42.5	60	30
	PSXG-48B	48	50	47.5	54.5	70	30

For applications with highest fire safety performance requirements / with extreme temperature conditions / exposed to radiation.
 Chemical resistance: To oils, fats, acids, alcohols and hot water (good resistance to hydrolysis)
 Excellent high and low temperature properties
 High radiation resistance
 Very good ductility

PSX Index

min.	max.
Ductility	
Fatigue reversed bending	
Compression resistance	
Low temperature performance	
Weathering resistance	

Materials	Temperature range	Colour
Specially modified polyetherimide	-100°C to +170°C	Black
Certification	Short-term to: +200°C	
Free from halogens, REACH compliant and RoHS compliant	Fire performance	UV Resistance
	Low smoke density and toxicity	-

PMAFLEX

Type CYL & ESD conduit

Type CYL - Very flexible, medium-duty conduit

	Order no. (black)	Order no. (grey)	Conduit size		Inside Ø (mm)	Outside Ø (mm)	Stat. radius (mm)	PU (m)
			NW	Metric				
	CYLT-07B	CYLT-07S	07	10	6.2	10.0	15	50
	CYLT-10B	CYLT-10S	10	12	9.6	13.0	20	50
	CYLT-12B	CYLT-12S	12	16	12.0	15.8	30	50
	CYLT-17B	CYLT-17S	17	20	16.2	21.2	40	50
	CYLT-23B	CYLT-23S	23	25	22.6	28.5	45	50
	CYLT-29B	CYLT-29S	29	32	29.0	34.5	55	50
	CYLT-36B	CYLT-36S	36	40	36.5	42.5	60	30
	CYLT-48B	CYLT-48S	48	50	47.5	54.5	70	30
	CYLG-23B	CYLG-23S	23	25	21.9	28.5	45	50
	CYLG-29B	CYLG-29S	29	32	27.6	34.5	55	50
	CYLG-36B	CYLG-36S	36	40	36.0	42.5	60	30
	CYLG-48B	CYLG-48S	48	50	47.0	54.5	70	30
	CYLG-56B	CYLG-56S	56	68	56.3	67.2	120	30
	CYLG-70B	CYLG-70S	70	80	68.0	80.0	160	10
	CYLG-95B	CYLG-95S	95	106	91.9	106.0	210	10
CYLG-125B	CYLG-125S	125	146	126.5	146.5	450	06	

Approvals



CYL Index

min.	max.
Ductility	
Fatigue reversed bending	
Compression resistance	
Low temperature performance	
Weathering resistance	

For machine building and installation industries / static and slightly dynamic applications
 Very good ductility and good reversed bending characteristics
 Good mechanical characteristics even under extreme conditions, such as low temperatures and low humidity

Materials	Temperature range	Colour
Specially formulated polyamide 6	-40°C to +105°C	Black/Grey
Certification	Short-term to: +160°C	
Free from halogens, REACH compliant and RoHS compliant	Self extinguishing	UV Resistance
	acc. to UL 94 V2	-

Type ESD - Very flexible, medium-duty conduit

	Order no. (black)	Conduit size		Inside Ø (mm)	Outside Ø (mm)	Stat./Dyn. radius (mm)	PU (m)
		NW	Metric				
	ESDT-07B	07	10	6.2	10.0	15/40	50
	ESDT-10B	10	12	9.6	13.0	20/50	50
	ESDT-12B	12	16	12.0	15.8	30/70	50
	ESDT-17B	17	20	16.4	21.1	40/75	50
	ESDT-23B	23	25	22.6	28.4	45/90	50
	ESDT-29B	29	32	29.0	34.3	55/110	50
	ESDT-36B	36	40	36.5	42.5	60/160	30
	ESDT-48B	48	50	47.5	54.5	70/200	30
	ESDG-56B	56	68	56.5	67.0	110/250	30
	ESDG-70B	70	80	67.5	80.0	150/330	10
	ESDG-95B	95	106	91.5	106.0	170/440	10

ESD Index

min.	max.
Ductility	
Fatigue reversed bending	
Compression resistance	
Low temperature performance	
Weathering resistance	

For dynamic applications in robotics and automation where electrostatic charge and uncontrolled discharge need to be avoided
 Prevents electrostatic charging. For indoor and outdoor use (very good cold temperature performance)

Materials	Temperature range	Colour
Specially modified polyamide 12	-40°C to +90°C	Black
Certification	Short-term to: +150°C	
Free from halogens, REACH compliant and RoHS compliant	Fatigue resistance	UV Resistance
	Excellent fatigue resistance	Excellent

PMAFLEX

Type PCL conduit

Type PCL - Very flexible, medium-duty

	Order no. (black)	Order no. (grey)	Conduit size		Inside Ø (mm)	Outside Ø (mm)	Stat. radius (mm)	PU (m)
			NW	Metric				
	PCLT-07B	PCLT-07S	07	10	6.2	10.0	15	50
	PCLT-10B	PCLT-10S	10	12	9.6	13.0	20	50
	PCLT-12B	PCLT-12S	12	16	12.0	15.8	30	50
	PCLT-17B	PCLT-17S	17	20	16.2	21.2	40	50
	PCLT-23B	PCLT-23S	23	25	22.6	28.5	45	50
	PCLT-29B	PCLT-29S	29	32	29.0	34.5	55	50
	PCLT-36B	PCLT-36S	36	40	36.5	42.5	60	30
	PCLT-48B	PCLT-48S	48	50	47.5	54.5	70	30
	PCLG-17B	PCLG-17S	17	20	15.3	21.2	40	50
	PCLG-23B	PCLG-23S	23	25	21.9	28.5	45	50
	PCLG-29B	PCLG-29S	29	32	27.6	34.5	55	50
	PCLG-36B	PCLG-36S	36	40	36.0	42.5	60	30
	PCLG-48B	PCLG-48S	48	50	47.0	54.5	70	30
	PCLG-56B	PCLG-56S	56	68	56.3	67.2	130	30
	PCLG-70B	PCLG-70S	70	80	67.5	80.0	160	10
	PCLG-95B	PCLG-95S	95	106	91.5	106.0	210	10
PCLG-125B	PCLG-125S	125	146	126.5	146.5	450	6	

Approvals



PCL Index

min.	max.
Ductility	
Fatigue reversed bending	
Compression resistance	
Low temperature performance	
Weathering resistance	

For machine building, installation and vehicle building industries / static and slightly dynamic applications
 Very good ductility and good reversed bending characteristics. Very good long-term properties
 Very good mechanical characteristics even under extreme conditions, such as low temperatures and low humidity

Materials	Temperature range	Colour
Specially formulated polyamide 6	-50°C to +105°C	Black/Grey
Certification	Short-term to: +160°C	
Free from halogens, REACH compliant and RoHS compliant	Self extinguishing	UV Resistance
	acc. to UL 94 V2	-

PMAFLEX

Type PCS & PCSL conduit

Type PCS - Very flexible, heavy-duty conduit

	Order no. (black)	Order no. (grey)	Conduit size		Inside Ø (mm)	Outside Ø (mm)	Stat./Dyn. radius (mm)	PU (m)
			NW	Metric				
	PCST-07B	PCST-07S	07	10	6.0	10.0	15/40	50
	PCST-10B	PCST-10S	10	12	9.2	13.0	20/50	50
	PCST-12B	PCST-12S	12	16	11.8	15.8	25/70	50
	PCST-17B	PCST-17S	17	20	16.0	21.2	35/80	50
	PCSG-17B	PCSG-17S	17	20	15.2	21.2	35/85	50
	PCSG-23B	PCSG-23S	23	25	21.5	28.5	40/110	50
	PCSG-29B	PCSG-29S	29	32	27.7	34.4	50/130	50
	PCSG-36B	PCSG-36S	36	40	35.8	42.4	60/180	30
	PCSG-48B	PCSG-48S	48	50	46.8	54.4	70/220	30
	PCSG-56B	PCSG-56S	56	68	56.1	67.2	130/280	30
	PCSG-70B	PCSG-70S	70	80	66.5	80.0	170/360	10
	PCSG-95B	PCSG-95S	95	106	91.0	106.0	250/470	10

For dynamic outside applications in railway vehicles / outdoor applications with highest requirements to UV and weathering resistance
Extensive railway approvals. Very good ductility and good reversed bending characteristics
Very good mechanical characteristics even under extreme conditions, such as low temperatures and low humidity
Highest reversed bending resistance
Excellent resistance to ultra violet rays and weathering

PCS Index

min.
Ductility

max.

Fatigue reversed bending

Compression resistance

Low temperature performance

Weathering resistance

Materials

Specially modified polyamide 12

Certification

Free from halogens, REACH compliant
and RoHS compliant

Temperature range

-50°C to +95°C

Short-term to: +150°C

Fatigue resistance

Excellent fatigue resistance

Colour

Black/Grey

UV Resistance

Excellent

Type PCSL - Highly flexible, medium-duty conduit

	Order no. (black)	Order no. (grey)	Conduit size		Inside Ø (mm)	Outside Ø (mm)	Stat./Dyn. radius (mm)	PU (m)
			NW	Metric				
	PCSLT-07B	PCSLT-07S	07	10	6.2	10.0	15/40	50
	PCSLT-10B	PCSLT-10S	10	12	9.6	13.0	20/50	50
	PCSLT-12B	PCSLT-12S	12	16	11.9	15.8	25/65	50
	PCSLT-17B	PCSLT-17S	17	20	16.4	21.1	30/65	50
	PCSLG-17B	PCSLG-17S	17	20	15.2	21.1	30/80	50
	PCSLG-23B	PCSLG-23S	23	25	21.7	28.4	40/100	50
	PCSLG-29B	PCSLG-29S	29	32	27.4	34.3	50/120	50
	PCSLG-36B	PCSLG-36S	36	40	35.8	42.3	60/180	30
	PCSLG-48B	PCSLG-48S	48	50	46.7	54.2	70/200	30

For dynamic outside applications in railway vehicles / outdoor applications with highest requirements to UV and weathering resistance
Extensive railway approvals. Good mechanical characteristics even under extreme conditions, such as low temperatures and low humidity
Excellent reversed bending resistance
Excellent resistance to ultra violet rays and weathering

PCSL Index

min.
Ductility

max.

Fatigue reversed bending

Compression resistance

Low temperature performance

Weathering resistance

Materials

Specially modified polyamide 12

Certification

Free from halogens, REACH compliant
and RoHS compliant

Temperature range

-50°C to +95°C

Short-term to: +150°C

Fatigue resistance

Excellent fatigue resistance

Colour

Black

UV Resistance

Excellent

PMAFLEX

Type PEL & PIS/PIH conduit

Type PEL - Highly flexible, light-duty, soft

	Order no. (grey)	Order no. (grey, slit)	Conduit size		Inside Ø (mm)	Outside Ø (mm)	Stat. radius (mm)	PU (m)
			NW	Metric				
	PELT-10S	PELT-10SL	10	12	9.7	12.7	20	50
	PELT-12S	PELT-12SL	12	16	11.5	15.5	30	50
	PELT-17S	PELT-17SL	17	20	16.0	20.9	35	50
	PELT-23S	PELT-23SL	23	25	22.5	27.5	40	50
	PELT-29S	PELT-29SL	29	32	28.5	33.8	50	30
	PELT-36S	PELT-36SL	36	40	34.0	41.6	60	30
	PELT-48S	PELT-48SL	48	50	47.0	53.2	70	30

For electrical cabinets and appliance construction
 Very good ductility
 Suitable for small bending radii
 Good resistance against strong acids and bases

PEL Index

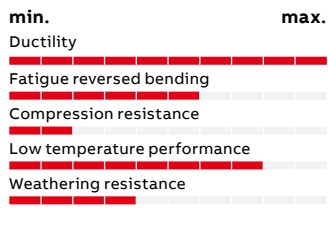

Materials	Temperature range	Colour
Specially modified polyethylene	-50°C to +60°C	Grey
Certification	UV Resistance	
Free from halogens, REACH compliant and RoHS compliant	-	

Type PIS/PIH - Highly flexible, medium- and heavy-duty

	Order no. (black)	Order no. (grey)	Conduit size		Inside Ø (mm)	Outside Ø (mm)	Stat./dyn. radius (mm)	PU (m)
			NW	Metric				
	PIST-07B	PIST-07S	07	10	6.2	10.0	15/40	50
	PIST-10B	PIST-10S	10	12	9.6	13.0	20/50	50
	PIST-12B	PIST-12S	12	16	11.9	15.8	25/65	50
	PIST-17B	PIST-17S	17	20	16.4	21.1	30/65	50
	PIST-23B	PIST-23S	23	25	22.6	28.4	35/90	50
	PIST-29B	PIST-29S	29	32	29.0	34.3	45/110	50
	PIST-36B	PIST-36S	36	40	36.5	42.5	60/165	30
	PIST-48B	PIST-48S	48	50	47.5	54.5	70/180	30
	PISG-17B	PISG-17S	17	20	15.2	21.1	30/80	50
	PISG-23B	PISG-23S	23	25	21.7	28.4	40/100	50
	PISG-29B	PISG-29S	29	32	27.9	34.7	50/120	50
	PISG-36B	PISG-36S	36	40	35.8	42.3	60/180	30
	PISG-48B	PISG-48S	48	50	46.7	54.2	70/200	30
	PIHG-56B	PIHG-56S	56	68	56.3	67.2	110/270	30
	PIHG-70B	PIHG-70S	70	80	67.2	79.6	150/350	30
	PIHG-95B	PIHG-95S	95	106	91.3	106.0	170/450	30
	PIHG-125B	PIHG-125S	125	146	126.5	146.5	350/480	20

For robotics and automation applications. UL 94 V0. Excellent UV resistance and weathering characteristics
 PIS: Medium-wall (Nominal width 07 to 48) / PIH: Heavy-wall (Nominal width 56 to 125)
 Very good reversed bending characteristics. Good mechanical characteristics even under extreme conditions, such as low temperatures and low humidity

Approvals



PIS/PIH Index

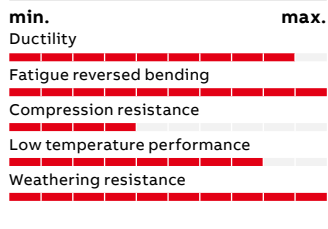

Materials	Temperature range	Colour
Specially modified polyamide 12	-50°C to +95°C	Black/Grey
Certification	Weathering characteristics	UV Resistance
Free from halogens, REACH compliant and RoHS compliant	Short-term to: +150°C Excellent	Excellent

PMAFLEX

Type POS & PUE conduit

Type POS - Highly flexible, medium-duty

	Order no. (black)	Conduit size		Inside Ø (mm)	Outside Ø (mm)	Stat./Dyn. radius (mm)	PU (m)
		NW	Metric				
	POST-10B	10	12	9.6	13	20/50	50
	POST-12B	12	16	11.9	15.8	30/70	50
	POST-17B	17	20	16.2	21.2	35/75	50
	POST-23B	23	25	22.6	28.5	40/100	50
	POST-29B	29	32	29	34.5	50/120	50
	POST-36B	36	40	36.5	42.5	60/180	30
	POST-48B	48	50	47.5	54.5	70/195	30
	POSG-29B	29	32	27.6	34.5	50/120	50
	POSG-36B	36	40	36	42.5	60/180	30
	POSG-48B	48	50	47	54.5	70/195	30
	POSG-70B	70	80	67.2	79.6	150/350	30
	POSG-95B	95	106	91.3	106	170/450	30

POS Index

For automation as well as for machine building and industrial installations, especially where continuous movements occur
Excellent reversed bending performance and flexibility
Good impact resistance. Good resistance against strong acids

min.	max.	Materials	Temperature range	Colour
Ductility				
Fatigue reversed bending		Specially modified polypropylene	-25°C to +95°C	Black
Compression resistance				
Low temperature performance		Certification	Short-term to: +130°C	
Weathering resistance		Free from halogens, REACH compliant and RoHS compliant	Fatigue resistance	UV Resistance
			-	-

Type PUE - Highly flexible, medium-duty

	Order no. (black)	Conduit size		Inside Ø (mm)	Outside Ø (mm)	Stat./Dyn. radius (mm)	PU (m)
		NW	Metric				
	PUET-23B	23	25	22.4	28.5	35/70	50
	PUET-29B	29	32	28.8	34.5	40/90	30
	PUET-36B	36	40	35.8	42.4	50/120	30
	PUET-48B	48	50	48.6	54.5	60/130	21
	PUEG-56B	56	68	56.3	67.2	90/170	30
	PUEG-70B	70	80	68.2	80.5	100/220	30

For robotic applications with multi-axial movements
Specially suitable for tight bending-radii
Highest reversed bending resistance
Excellent chafing characteristics

PUE Index

min.	max.	Materials	Temperature range	Colour
Ductility				
Fatigue reversed bending		Specially formulated polyurethane	-60°C to +50°C	Black
Compression resistance				
Low temperature performance		Certification		
Weathering resistance		Free from halogens, REACH compliant and RoHS compliant	Fatigue resistance	UV Resistance
			-	-

PMAFLEX

Type PVD & VAM conduit

Type PVD - Pliable, medium-duty

	Order no. (transparent)	Conduit size		Inside Ø (mm)	Outside Ø (mm)	Stat. radius (mm)	PU (m)
		NW	Metric				
	PVDT-10P	10	12	9.5	12.6	20	50
	PVDT-12P	12	16	11.8	15.5	30	50
	PVDT-17P	17	20	16.0	20.8	40	50
	PVDT-23P	23	25	22.6	28.0	45	50
	PVDT-29P	29	32	29.0	34.1	50	50

For long-term high temperature requirements in machine building applications
 Excellent chemical resistance also at high temperatures
 Very good abrasion resistance
 High stiffness

PVD Index

min. max.

Ductility

Fatigue reversed bending

Compression resistance

Low temperature performance

Weathering resistance

Materials

Specially formulated PVDF

Certification

Free from halogens, REACH compliant
 and RoHS compliant

Temperature range

-60°C to +150°C

Fire performance

Self-extinguishing / free from cadmium

Colour

Transparent

UV Resistance

Excellent

Type VAM - Flexible, heavy-duty

	Order no. (black)	Order no. (grey)	Conduit size		Inside Ø (mm)	Outside Ø (mm)	Stat. radius (mm)	PU (m)
			NW	Metric				
	VAMT-10B	VAMT-10S	10	12	9.2	13.0	25	50
	VAMT-12B	VAMT-12S	12	16	11.8	15.8	30	50
	VAMG-17B	VAMG-17S	17	20	15.2	21.2	40	50
	VAMG-23B	VAMG-23S	23	25	22.0	28.5	50	50
	VAMG-29B	VAMG-29S	29	32	27.7	34.4	60	50
	VAMG-36B	VAMG-36S	36	40	35.8	42.4	70	30
	VAMG-48B	VAMG-48S	48	50	46.8	54.4	80	30

For high fire and passenger safety requirements in interior applications such as passenger areas or public buildings
 HL3 acc. to EN 45545-2
 NFPA 130 compliant
 High impact and compression strength
 High stiffness

VAM Index

min. max.

Ductility

Fatigue reversed bending

Compression resistance

Low temperature performance

Weathering resistance

Materials

Specially formulated polyamide 6

Certification

Free from halogens, REACH compliant
 and RoHS compliant

Temperature range

-40°C to +105°C

Short-term to: +160°C

Fire performance

Minimal development of smoke and gases

Colour

Black/Grey

UV Resistance

-

PMAFLEX

Type VAML & VCS conduit

Type VAML - Flexible, medium-duty

	Order no. (black)	Order no. (grey)	Conduit size		Inside Ø (mm)	Outside Ø (mm)	Stat. radius (mm)	PU (m)
			NW	Metric				
	VAMLT-10B	VAMLT-10S	10	12	9.6	13.0	20	50
	VAMLT-12B	VAMLT-12S	12	16	12.0	15.8	30	50
	VAMLG-17B	VAMLG-17S	17	20	15.3	21.2	40	50
	VAMLG-23B	VAMLG-23S	23	25	22.6	28.5	45	50
	VAMLG-29B	VAMLG-29S	29	32	27.6	34.5	55	50
	VAMLG-36B	VAMLG-36S	36	40	36.0	42.5	65	30
	VAMLG-48B	VAMLG-48S	48	50	47.0	54.5	75	30
	VAMLG-56B	VAMLG-56S	56	68	56.3	67.2	140	30
	VAMLG-70B	VAMLG-70S	70	80	67.5	80.0	160	10
	VAMLG-95B	VAMLG-95S	95	106	91.5	106.0	210	10
	VAMLG-125B	VAMLG-125S	125	146	126.0	146.5	450	6

VAML Index

min. Ductility **max.**

Fatigue reversed bending
 Compression resistance
 Low temperature performance
 Weathering resistance

For high fire and passenger safety requirements in interior applications such as passenger areas or public buildings
 HL3 acc. to EN 45545-2
 NFPA 130 compliant
 Good flexibility. Good impact strength

Materials	Temperature range	Colour
Specially formulated polyamide 6	-40°C to +105°C	Black/Grey
Certification	Short-term to: +160°C	
Free from halogens, REACH compliant and RoHS compliant	Fire performance	UV Resistance
	Minimal development of smoke and gases	-

Type VCS - Flexible, heavy-duty

	Order no. (black)	Order no. (grey)	Conduit size		Inside Ø (mm)	Outside Ø (mm)	Stat. radius (mm)	PU (m)
			NW	Metric				
	VCST-07B	VCST-07S	07	10	6.0	10.0	20	100
	VCST-10B	VCST-10S	10	12	9.2	13.0	25	50
	VCST-12B	VCST-12S	12	16	11.8	15.8	30	50
	VCST-17B	VCST-17S	17	20	16.0	21.2	40	50
	VCSG-17B	VCSG-17S	17	20	15.2	21.2	40	50
	VCSG-23B	VCSG-23S	23	25	22.0	28.5	50	50
	VCSG-29B	VCSG-29S	29	32	27.7	34.4	60	50
	VCSG-36B	VCSG-36S	36	40	35.8	42.4	70	30
	VCSG-48B	VCSG-48S	48	50	46.8	54.4	80	30
	VCSG-56B	VCSG-56S	56	68	56.1	67.2	150	30
	VCSG-70B	VCSG-70S	70	80	66.5	80.0	200	10
	VCSG-95B	VCSG-95S	95	106	91.0	106.0	300	10

VCS Index

min. Ductility **max.**

Fatigue reversed bending
 Compression resistance
 Low temperature performance
 Weathering resistance

For static external installations, especially in railway vehicles
 High compression and impact strengths at low temperatures and low humidity
 Good ductility. Very good resistance to ultra violet rays and weathering

Materials	Temperature range	Colour
Specially formulated polyamide 6	-50°C to +105°C	Black/Grey
Certification	Short-term to: +160°C	
Free from halogens, REACH compliant and RoHS compliant	Fatigue resistance	UV Resistance
	-	Very good

PMAFLEX

Type VOH & PLR conduit

Type VOH - Pliable, very heavy-duty

	Order no. (black)	Order no. (grey)	Conduit size		Inside Ø (mm)	Outside Ø (mm)	Stat. radius (mm)	PU (m)
			NW	Metric				
	VOHD-07B	VOHD-07S	07	10	5.8	10.0	30	50
	VOHD-10B	VOHD-10S	10	12	9.0	13.0	35	50
	VOHD-12B	VOHD-12S	12	16	11.6	15.8	40	50
	VOHG-17B	VOHG-17S	17	20	14.5	21.0	60	50
	VOHG-23B	VOHG-23S	23	25	21.1	28.5	70	50
	VOHG-29B	VOHG-29S	29	32	26.6	34.5	80	50
	VOHG-36B	VOHG-36S	36	40	35.0	42.5	90	30
	VOHG-48B	VOHG-48S	48	50	46.5	54.5	100	30
	VOHG-56B	VOHG-56S	56	68	55.5	67.2	135	10
	VOHG-70B	VOHG-70S	70	80	67.0	80.0	200	10
	VOHG-95B	VOHG-95S	95	106	90.5	106.0	300	10
	VOHG-125B	VOHG-125S	125	146	126.0	146.5	480	6

For applications in heavy machine and plant construction
 High compression resistance
 Highest degree of mechanical protection
 Very good UV and weathering resistance
 Good fire safety characteristics

VOH Index

min.	max.
Ductility	
Fatigue reversed bending	
Compression resistance	
Low temperature performance	
Weathering resistance	

Materials	Temperature range	Colour
Specially modified polyamide 6	-40°C to +105°C	Black/Grey
Certification	Short-term to: +160°C	
Free from halogens, REACH compliant and RoHS compliant	Fire performance	UV Resistance
	Good	Very good

Type PLR - flexible, medium-wall

	Order no. (black)	Order no. (grey)	Conduit size			Inside Ø (mm)	Outside Ø (mm)	Stat. radius (mm)	PU (m)
			NW	Metric	Profile				
	PLRT-07B	PLRT-07S	07	10	T	6.2	10.0	15	50
	PLRT-10B	PLRT-10S	10	12	T	9.6	13.0	20	50
	PLRT-12B	PLRT-12S	12	16	T	12.0	15.8	30	50
	PLRG-17B	PLRG-17S	17	20	G	15.8	21.2	40	50
	PLRG-23B	PLRG-23S	23	25	G	21.9	28.5	45	50
	PLRG-29B	PLRG-29S	29	32	G	27.6	34.5	55	50
	PLRG-36B	PLRG-36S	36	40	G	36.0	42.5	60	30
	PLRG-48B	PLRG-48S	48	50	G	47.0	54.5	70	30

In light rail rolling stock applications e.g. Tram, Metro, Monorail
 HL2 acc. to EN 45545-2
 Good pressure resistance
 Very good fire safety characteristics

PLR Index

min.	max.
Ductility	
Fatigue reversed bending	
Compression resistance	
Low temperature performance	
Weathering resistance	

Materials	Temperature range	Colour
Specially modified polyamide 6	-40°C to +105°C	Black/Grey
Certification	Short-term to: +160°C	
Free from halogens, REACH compliant and RoHS compliant	Fire performance	UV Resistance
	Self-extinguishing / Very good	-

PMAFLEX Multilayer





Type XPCL & XSOL conduit

Type XPCL - Highly flexible, medium-duty

	Order no. (black/blue)	Order no. (grey/blue)	Conduit size		Inside Ø (mm)	Outside Ø (mm)	Stat. radius (mm)	PU (m)
			NW	Metric				
	XPCLT-10BB	XPCLT-10SB	10	12	9.6	13.0	20	50
	XPCLT-12BB	XPCLT-12SB	12	16	11.8	15.6	30	50
	XPCLT-17BB	XPCLT-17SB	17	20	16.6	21.0	40	50
	XPCLG-17BB	XPCLG-17SB	17	20	15.6	20.9	40	50
	XPCLG-23BB	XPCLG-23SB	23	25	21.9	28.5	45	50
	XPCLG-29BB	XPCLG-29SB	29	32	27.6	34.5	55	50
	XPCLG-36BB	XPCLG-36SB	36	40	36.0	42.5	60	30
	XPCLG-48BB	XPCLG-48SB	48	50	47.0	54.5	70	30

For machine building and equipment with high requirements
 Allows easy cable insertion due to low friction inner layer
 Very good ductility and good reversed bending characteristics
 Good mechanical characteristics even under extreme conditions, such as low temperatures and low humidity

XPCL Index

min.	max.	Materials	Temperature range	Colour
Ductility		Outer layer: Specially formulated polyamide 6	-50°C to +105°C	Black/Blue
Fatigue reversed bending		Intermediate layer: Specially bonding compound	Short-term to: +160°C	Grey/Blue
Compression resistance		Inner layer: Specially modified polyethylene		
Low temperature performance		Certification	Fire performance	UV Resistance
Weathering resistance		Free from halogens, REACH compliant and RoHS compliant	Self-extinguishing	-

Type XSOL - Highly flexible, medium-duty





	Order no. (black/green)	Conduit size		Inside Ø (mm)	Outside Ø (mm)	Stat. radius (mm)	PU (m)
		NW	Metric				
	XSOLT-10BG	10	12	9.6	13.0	25	50
	XSOLT-12BG	12	16	11.8	15.6	30	50
	XSOLG-17BG	17	20	15.2	21.0	40	50
	XSOLG-23BG	23	25	22.0	28.5	50	50
	XSOLG-29BG	29	32	27.5	34.4	60	50
	XSOLG-36BG	36	40	35.8	42.4	70	30
	XSOLG-48BG	48	50	46.8	54.4	80	30

All-purpose, especially in long-term external applications, e.g. energy technology
 Very good resistance to UV and weathering
 Very high ductility and reversed bending resistance
 Very good mechanical strength
 High impact resistance even under extreme conditions, such as low temperatures and low humidity

Approvals

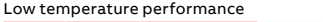

XSOL Index

min.	max.	Materials	Temperature range	Colour
Ductility		Outer layer: Specially formulated polyamide 12	-50°C to +95°C	Black/Green
Fatigue reversed bending		Intermediate layer: Specially bonding compound	Short-term to: +150°C	
Compression resistance		Inner layer: Specially modified polyamide 6		
Low temperature performance		Certification	Fire performance	UV Resistance
Weathering resistance		Free from halogens, REACH compliant and RoHS compliant	Good fire safety characteristics Self-extinguishing	Very good

PMAFLEX Multilayer





Type XVCS1H & XVCS2H conduit

Type XVCS1H - Flexible, heavy-duty

	Order no. (black/green)	Conduit size		Inside Ø (mm)	Outside Ø (mm)	Stat. radius (mm)	PU (m)
		NW	Metric				
	XVCS1H-10BG	10	12	9.2	13.0	25	50
	XVCS1H-12BG	12	16	11.7	15.5	30	50
	XVCS1H-17BG	17	20	15.2	21.0	40	50
	XVCS1H-23BG	23	25	21.7	28.4	50	50
	XVCS1H-29BG	29	32	27.5	34.3	60	50
	XVCS1H-36BG	36	40	35.8	42.2	70	30
	XVCS1H-48BG	48	50	46.8	54.3	80	30

For track side applications and other exterior static applications
 Easy layouting through: High conduit ductility and formability / Low friction inner layer facilitates cable insertion
 Excellent impact characteristics at low temperatures

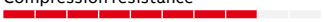
XVCS1H Index





min.	max.	Materials	Temperature range	Colour
Ductility		Outer layer: Specially formulated polyamide 6	-50°C to +90°C	Black/Green
Fatigue reversed bending		Intermediate layer: Specially bonding compound	Short-term to: +120°C	
Compression resistance		Inner layer: Specially modified polyolefin		
Low temperature performance		Certification	Atmospheric corrosion resistance	UV Resistance
Weathering resistance		Free from halogens, REACH compliant and RoHS compliant	Very good	Very good

Type XVCS2H - Flexible, heavy-duty

	Order no. (black/green)	Conduit size		Inside Ø (mm)	Outside Ø (mm)	Stat. radius (mm)	PU (m)
		NW	Metric				
	XVCS2H-10BG	10	12	9.2	13.0	20	50
	XVCS2H-12BG	12	16	11.7	15.5	25	50
	XVCS2H-17BG	17	20	15.2	21.0	35	50
	XVCS2H-23BG	23	25	22.0	28.4	40	50
	XVCS2H-29BG	29	32	27.7	34.3	50	50
	XVCS2H-36BG	36	40	35.8	42.2	60	30
	XVCS2H-48BG	48	50	46.8	54.3	70	30

For track side applications and other exterior static applications with high UV exposure
 Easy layouting through: High conduit ductility and formability / Low friction inner layer facilitates cable insertion
 Excellent impact characteristics at low temperatures

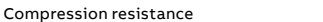
XVCS2H Index

min.	max.	Materials	Temperature range	Colour
Ductility		Outer layer: Specially formulated polyamide 12	-50°C to +90°C	Black/Green
Fatigue reversed bending		Intermediate layer: Specially bonding compound	Short-term to: +120°C	
Compression resistance		Inner layer: Specially modified polyolefin		
Low temperature performance		Certification	Atmospheric corrosion resistance	UV Resistance
Weathering resistance		Free from halogens, REACH compliant and RoHS compliant	Excellent	Excellent

PMAFLEX Multilayer



Type XPCS & XPCSF conduit

Type XPCS - Very flexible, heavy-duty

	Order no. (black/green)	Conduit size		Inside Ø (mm)	Outside Ø (mm)	Stat. radius (mm)	Dyn. radius (mm)	PU (m)
		NW	Metric					
	XPCST-10BG	10	12	9.2	13.0	20	50	50
	XPCST-12BG	12	16	11.8	15.8	25	70	50
	XPCSG-17BG	17	20	15.2	21.2	35	85	50
	XPCSG-23BG	23	25	21.5	28.5	40	110	50
	XPCSG-29BG	29	32	27.7	34.4	50	130	50
	XPCSG-36BG	36	40	35.8	42.4	60	180	30
	XPCSG-48BG	48	50	46.8	54.4	70	220	30

For dynamic outside applications in railway vehicles
 For outdoor applications with highest requirements to UV and weathering resistance
 Extensive railway approvals
 Good mechanical characteristics even under extreme conditions, such as low temperatures and low humidity
 HL2 acc. to EN 45545-2
 NFPA 130 compliant

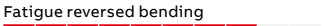
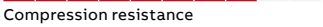
XPCS Index





min.	max.	Materials	Temperature range	Colour
Ductility		Outer layer: Specially formulated polyamide 12	-40°C to +95°C	Black/Green
Fatigue reversed bending		Inner layer: Specially formulated polyamide 6	Short-term to: +150°C	
Compression resistance				
Low temperature performance				
Weathering resistance				
		Certification	Fire performance	UV Resistance
		Free from halogens, REACH compliant and RoHS compliant	Self-extinguishing	Excellent

Type XPCSF - Very flexible, heavy-duty

	Order no. (black/orange)	Conduit size		Inside Ø (mm)	Outside Ø (mm)	Stat. radius (mm)	Dyn. radius (mm)	PU (m)
		NW	Metric					
	XPCSFT-07BO	07	10	06	10	15	40	100
	XPCSFT-10BO	10	12	9.2	13.0	20	50	50
	XPCSFT-12BO	12	16	11.8	15.8	25	70	50
	XPCSFG-17BO	17	20	15.2	21.2	35	85	50
	XPCSFG-23BO	23	25	21.5	28.5	40	110	50
	XPCSFG-29BO	29	32	27.5	34.4	50	130	50
	XPCSFG-36BO	36	40	35.8	42.4	60	180	30
XPCSFG-48BO	48	50	46.8	54.4	70	220	30	

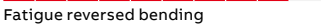
For dynamic outside applications in railway vehicles
 For outdoor applications with highest requirements to UV and weathering resistance
 Extensive railway approvals
 Excellent flexibility
 Very good mechanical characteristics even under extreme conditions, such as low temperatures and low humidity
 HL3 acc. to EN 45545-2

XPCSF Index

min.	max.	Materials	Temperature range	Colour
Ductility		Outer layer: Specially formulated polyamide 12	-40°C to +95°C	Black/Orange
Fatigue reversed bending		Inner layer: Specially formulated polyamide 12	Short-term to: +150°C	
Compression resistance				
Low temperature performance				
Weathering resistance				
		Certification	Fire performance	UV Resistance
		Free from halogens, REACH compliant and RoHS compliant	Self-extinguishing	Excellent

PMA OXC Overextruded

Type JFBD conduit

Type JFBD - Flexible, medium-duty

	Order no.	Conduit size		Inside Ø (mm)	Outside Ø (mm)	Stat. radius (mm)	Dyn. radius (mm)	PU (mm)
		NW	Metric					
	JFBTD-12C01	12	16	11.8	16.0	70	100	50
	JFBGD-17C01	17	20	15.6	21.6	85	125	50
	JFBGD-23C01	23	25	21.7	28.8	110	160	50
	JFBGD-29C01	29	32	27.4	34.7	140	200	50
	JFBGD-36C01	32	40	35.8	42.7	200	260	30
	JFBGD-48C01	48	50	46.7	54.6	230	300	30

Smooth easy to clean out layer
 High reversed bending stresses
 Excellent flexibility in combination with high strength
 High resistance to chemicals and cleaning agents
 For indoor food zone – non contact
 Outer layer made from FDA compliant material
 Corrosion free

Approvals



JFBD Index

min.	max.	Materials	Colour
Ductility		Conduit: made from high-grade, specially formulated polyamide 12	Corrugated conduit: blue
Fatigue reversed bending		Overextrusion: made from modified polyamide elastomer	Overextrusion: blue, translucent
Compression resistance		Certification	UV Resistance
Low temperature performance		FDA 21 CFR / EU 10/2011 compliant outer layer material; ECOLAB certificate	-
Weathering resistance			

PMAFLEX Plus

Type CUS & PUS conduit

Type CUS - Very flexible, medium-duty

	Order no. (black)	Order no. (grey)	Conduit size			Inside Ø (mm)	Outside Ø (mm)	Stat. radius (mm)	PU (m/ft)
			Inch	NW	Metric				
	CUSG-17B	CUSG-17S	½	17	20	15.2	21.2	40	31/100
	CUSG-23B	CUSG-23S	¾	23	25	21.9	28.5	45	31/100
	CUSG-29B	CUSG-29S	1	29	32	27.6	34.5	55	31/100
	CUSG-36B	CUSG-36S	1¼	36	40	36.0	42.5	60	31/100
	CUSG-48B	CUSG-48S	1½	48	50	47.0	54.5	70	31/100

For machine building and installation industries
 For electrical installations, especially in the US market
 Inexpensive solution for requirements acc. to UL 1660 (UL Listing)
 Good ductility and reversed bending characteristics
 Very good mechanical properties even under extreme conditions, such as low temperatures and low humidity

Approvals



CUS Index

min.	max.
Ductility	
Fatigue reversed bending	
Compression resistance	
Low temperature performance	
Weathering resistance	

Materials	Temperature range	Colour
Specially modified polyamide 6	-40°C to +105°C	Black/Grey
Certification	Short-term to: +160°C	
Free from halogens, REACH compliant and RoHS compliant	Fire protection	UV Resistance
	Self-extinguishing, acc. to UL 94 V2	-

Type PUS - Very flexible, heavy-duty

	Order no. (black)	Order no. (grey)	Conduit size			Inside Ø (mm)	Outside Ø (mm)	Stat./Dyn. radius (mm)	PU (m/ft)
			Inch	NW	Metric				
	PUSG-17B	PUSG-17S	½	17	20	15.2	21.2	35/85	31/100
	PUSG-23B	PUSG-23S	¾	23	25	22.0	28.5	40/110	31/100
	PUSG-29B	PUSG-29S	1	29	32	27.7	34.4	50/130	31/100
	PUSG-36B	PUSG-36S	1¼	36	40	35.8	42.4	60/180	31/100
	PUSG-48B	PUSG-48S	1½	48	50	46.8	54.4	70/220	31/100

For long-term external applications with approval acc. to UL 1660 (UL Listing)
 For dynamic applications
 Very good reversed bending resistance
 Very good mechanical strength at low temperatures
 Excellent resistance to ultra violet rays and weathering
 cULus listed

Approvals



PUS Index

min.	max.
Ductility	
Fatigue reversed bending	
Compression resistance	
Low temperature performance	
Weathering resistance	

Materials	Temperature range	Colour
Specially modified polyamide 12	-50°C to +95°C	Black/Grey
Certification	Short-term to: +150°C	
Free from halogens, REACH compliant and RoHS compliant	Fire protection	UV Resistance
	Self-extinguishing, acc. to UL 94 V2	Excellent

PMAFLEX Plus

Type VUS conduit

Type VUS - Flexible, heavy-duty

	Order no. (black)	Order no. (grey)	Conduit size		Inside Ø (mm)	Outside Ø (mm)	Stat. radius (mm)	PU (m/ft)
			Inch	NW Metric				
	VUSG-17B	VUSG-17S	½	17 20	15.2	21.2	40	31/100
	VUSG-23B	VUSG-23S	¾	23 25	22.0	28.5	50	31/100
	VUSG-29B	VUSG-29S	1	29 32	27.7	34.4	60	31/100
	VUSG-36B	VUSG-36S	1 ¼	36 40	35.8	42.4	70	31/100
	VUSG-48B	VUSG-48S	1 ½	48 50	46.8	54.4	80	31/100

For static exterior installations with approval acc. to UL 1660 (UL Listing)
 For applications requiring high compression resistance
 Good ductility
 High mechanical strength even under extreme conditions, such as low temperatures and low humidity
 Very good resistance to ultra violet rays and weathering

Approvals



VUS Index

min. max.
 Ductility



Materials	Temperature range	Colour
Specially modified polyamide 6	-50°C to +105°C	Black/Grey
Certification	Fire performance	UV Resistance
Free from halogens, REACH compliant and RoHS compliant	Short-term to: +160°C	-
		Very good

PMA Divisible System

Type PACOF conduit & stainless steel overbraiding for conduit

Type PACOF - Flexible, divisible

	Order no. (black)	Conduit size			Inside Ø (mm)	Outside Ø (mm)	Stat. radius (mm)	PU (m)
		NW	Metric	Profile				
	PACOF-07B	07	10	T	5.6	10.0	30	50
	PACOF-10B	10	12	T	8.5	12.8	33	50
	PACOF-12B	12	16	T	11.0	15.6	35	50
	PACOF-17B	17	20	T	15.5	21.1	45	50
	PACOF-23B	23	25	T	22.1	28.4	70	50
	PACOF-29B	29	32	T	27.2	34.5	120	50
	PACOF-36B	36	40	T	32.0	42.4	145	30
	PACOF-48B	48	50	T	43.9	54.1	150	30
	PACOF-70B	70	80	T	62.0	79.0	190	10

HL3 according to EN45545-2

NFPA 130 compliant

For machine building and plant construction

For trouble-free retrofitting and applicable for repairs

Can be opened and closed again in longitudinal direction any time

Good ductility

Good compression resistance

PACOF Index

min. Ductility

max.

Fatigue reversed bending

Compression resistance

Low temperature performance

Weathering resistance

Materials

Specially modified polyamide 6

Certification

Free from halogens, REACH compliant

and RoHS compliant

Temperature range

-40°C to +105°C

Short-term to: +160°C

Fire performance

Colour

Black

UV Resistance

-

Type LLPO - Very flexible, light-duty

	Order no. (black)	Order no. (grey)	Conduit size			Inside Ø (mm)	Outside Ø (mm)	Stat. radius (mm)	PU (m)
			NW	Metric	Profile				
	LLPO-07A	LLPO-07S	07	10	T	6.2	10.0	15	50
	LLPO-10A	LLPO-10S	10	12	T	9.6	13.0	20	50
	LLPO-12A	LLPO-12S	12	16	T	12.0	15.8	30	50
	LLPO-17A	LLPO-17S	17	20	T	16.2	21.2	40	50
	LLPO-23A	LLPO-23S	23	25	T	22.6	28.5	45	50
	LLPO-29A	LLPO-29S	29	32	T	29.0	34.5	55	50
	LLPO-36A	LLPO-36S	36	40	T	36.5	42.5	60	30
	LLPO-48A	LLPO-48S	48	50	T	47.5	54.5	70	30

For machine building and installation

Excellent reversed bending characteristics

Very good resistance against acids and hydrolysis

LLPO Index

min. Ductility

max.

Fatigue reversed bending

Compression resistance

Low temperature performance

Weathering resistance

Materials

Specially modified polyolefine

Certification

Free from halogens, REACH compliant

and RoHS compliant

Temperature range

-20°C to +90°C

Short-term to: +130°C

Fire protection

Good flammability

Colour

Black/Grey

UV Resistance

-

PMA Smart Line

Type PPCOF & LLPA conduit

Type PPCOF - Flexible, divisible

	Order no. (black)	Conduit size		Inside Ø (mm)	Outside Ø (mm)	Stat. radius (mm)	PU (m)
		NW	Metric				
	PPCOF-07B	07	10	5.6	10.0	25	50
	PPCOF-10B	10	12	8.5	12.8	28	50
	PPCOF-12B	12	16	11.0	15.6	35	50
	PPCOF-17B	17	20	15.1	21.1	45	50
	PPCOF-23B	23	25	22.1	28.4	60	50
	PPCOF-29B	29	32	26.6	34.5	100	50
	PPCOF-36B	36	40	31.8	42.4	120	30
	PPCOF-48B	48	50	43.9	54.1	140	30
	PPCOF-70B	70	80	60.5	78.0	200	10

PPCOF Index

min. Ductility **max.** For machine building and plant construction
For trouble-free retrofitting and applicable for repairs
Can be opened and closed again in longitudinal direction any time
Good reversed bending resistance

	Materials	Temperature range	Colour
Fatigue reversed bending	Specially modified polypropylene PP	-20°C to +105°C Short-term to +150°C	Black
Compression resistance			
Low temperature performance			
	Certification	Fire performance	UV Resistance
Weathering resistance	-	-	-

Type LLPA - Very flexible, medium-duty

	Order no. (black)	Order no. (grey)	Conduit size			Inside Ø (mm)	Outside Ø (mm)	Stat. radius (mm)	PU (m)
			NW	Metric	Profile				
	LLPA-07A	LLPA-07S	07	10	T	6.2	10.0	15	50
	LLPA-10A	LLPA-10S	10	12	T	9.6	13.0	20	50
	LLPA-12A	LLPA-12S	12	16	T	12.0	15.8	30	50
	LLPA-17A	LLPA-17S	17	20	T	16.2	21.2	40	50
	LLPA-23A	LLPA-23S	23	25	T	22.6	28.5	45	50
	LLPA-29A	LLPA-29S	29	32	T	29.0	34.5	55	50
	LLPA-36A	LLPA-36S	36	40	T	36.5	42.5	60	30
	LLPA-48A	LLPA-48S	48	50	T	47.5	54.5	70	30

Approvals



LLPA Index

min. Ductility **max.** For machine building, installation and construction industries
Good ductility
Good mechanical characteristics

	Materials	Temperature range	Colour
Fatigue reversed bending	Specially modified polyamide 6	-40°C to +105°C Short-term to: +160°C	Black/Grey
Compression resistance			
Low temperature performance			
	Certification	Self extinguishing	UV Resistance
Weathering resistance	Free from halogens, REACH compliant and RoHS compliant	acc. to UL 94 V2	-

PMA Smart Line

Type LLPF & LLPG conduit

Type LLPF - Very flexible, medium-duty

	Order no. (black)	Order no. (grey)	Conduit size			Inside Ø (mm)	Outside Ø (mm)	Stat. radius (mm)	PU (m)
			NW	Metric	Profile				
	LLPF-07A	LLPF-07S	7	10	T	6.2	10.0	15	50
	LLPF-10A	LLPF-10S	10	12	T	9.6	13.0	20	50
	LLPF-12A	LLPF-12S	12	16	T	12.0	15.8	30	50
	LLPF-17A	LLPF-17S	17	20	T	16.2	21.2	40	50
	LLPF-23A	LLPF-23S	23	25	T	22.6	28.5	45	50
	LLPF-29A	LLPF-29S	29	32	T	29.0	34.5	55	50
	LLPFG-17A	LLPFG-17S	17	20	G	15.8	21.2	40	50
	LLPFG-23A	LLPFG-23S	23	25	G	21.9	28.5	45	50
	LLPFG-29A	LLPFG-29S	29	32	G	27.6	34.5	55	50
	LLPFG-36A	LLPFG-36S	36	40	G	36.0	42.5	60	30
LLPFG-48A	LLPFG-48S	48	50	G	47.0	54.5	70	30	

For machine building, installation and construction industries
For applications with high fire safety requirements
UL 94 V0

LLPF Index

min. Ductility
max. Good pressure resistance
Very good fire safety characteristics

	Materials	Temperature range	Colour
Fatigue reversed bending	Specially modified polyamide 6	-40°C to +105°C	Black/Grey
Compression resistance			
Low temperature performance	Certification	Short-term to: +160°C	
Weathering resistance	Free from halogens, REACH compliant and RoHS compliant	Fire protection	UV Resistance
		Self-extinguishing	-

PMA stainless steel overbraiding for conduit

Order no. (black)	Conduit size		for conduit profile	fits to metal connector	braid spec (mm)	d1 Ø (mm)	d2 Ø (mm)	weight net without conduit (kg/100 m)	PU (m)
	NW	Metric							
xxxT-12x/S	12	16	T	MONK-M162	24 x 8 x 0.30	*	17.5	11.9	50
xxxT-17x/S	17	20	T	MONK-M207	32 x 7 x 0.30	*	23.0	13.8	50
xxxG-17x/S	17	20	G	-	32 x 7 x 0.30	*	23.0	13.8	50
xxxG-23x/S	23	25	G	MONK-M253	36 x 8 x 0.30	*	31.0	17.8	50
xxxG-29x/S	29	32	G	MONK-M329	36 x 10 x 0.30	*	36.0	22.2	50
xxxG-36x/S	36	40	G	MONK-M406	36 x 12 x 0.30	*	44.5	26.7	30
xxxG-48x/S	48	50	G	MONK-M508	36 x 14 x 0.30	*	58.5	30.7	30

Our customer service or your local distribution partner will be pleased to help you concerning product availability and lead time

Application: in machine and railway construction; for high mechanical loads; in areas with hot swarf and flying sparks

Characteristics: increased mechanical conduit protection; extremely high abrasion resistance

Coverage: > 90%

Suitable for PMAFLEX, PMA Smart Line; Special metal fittings (MONK)

Materials	Temperature range	Colour
Braid made with stainless steel AISI	-70°C to +1000°C	Metal
Certification	Fire performance	UV Resistance
RoHS compliant		-

PMAFIX Pro

Introduction

Next generation cable protection. The extremely successful and technically proven PMAFIX System has been developed further to create the PMAFIX Pro product range.

The new generation fittings are the product of experience gained over many years in the most varied application areas. The PMAFIX Pro has two components, an outer body and an inner sealing element. The sealing element functions both as a seal and as a locking mechanism providing all ingress protection grades up to IP68 and IP69 even in applications where there is long term continuous movement. PMAFIX Pro is manufactured by using multiple component injection moulding process.

Key features

- Meets all ingress protection categories up to and including IP68 and IP69 also when the conduit connection is continually in motion
- Manufactured with newest 2-component injection moulding technology
- Fulfills highest international quality and standard requirements
- Intelligent safety locking mechanism
- Allows simple “push-in” installation of conduit
- Due to the integrated conduit supports conduit remains centralised with little deformation even when bent sharply directly at the fitting





PMAFIX Pro

General technical details

—
01 patent
—
02 Up to 100 bar

Material

- Fittings made from specially modified polyamide 6
- Threads made from nickel-plated brass or polyamide 6
- Sealings made from cross linked polyester elastomer
- Self-extinguishing
- Free from halogens, REACH + RoHS compliant
- Temperature range: -50°C to +105°C, short-term to +160°C

Characteristics

- Highest assembly reliability – the fitting only locks when the sealing element is fully inserted
- Highest operational safety assured through visual and acoustic correct assembly controls
- Excellent resistance to ultra violet rays and weathering
- Highest impact resistance through fully closed design
- Highest conduit pull out strength
- Vibration-proof connection to PMA conduit
- Fits conduit profiles – fine (T) and coarse (G)
- To avoid accidental opening, disassembling only possible with a screwdriver



—
01



—
02

IP68 + IP69

Static + dynamic

- Highest sealing through fully closed system also in highest dynamic applications
- Extra long ribbed sealing areas (cross linked material)
- 360° locking and sealing element shields against high pressure water jets (up to 100 bar)
- Content of delivery: Locking and sealing element and thread seal for male threads (O-Ring and/or flat gasket)

electrosuisse»

BOMBARDIER
Transportation



TRENITALIA



EN

ALSTOM



SIEMENS



IRIS
Certification



PMAFIX Pro

Part number codes

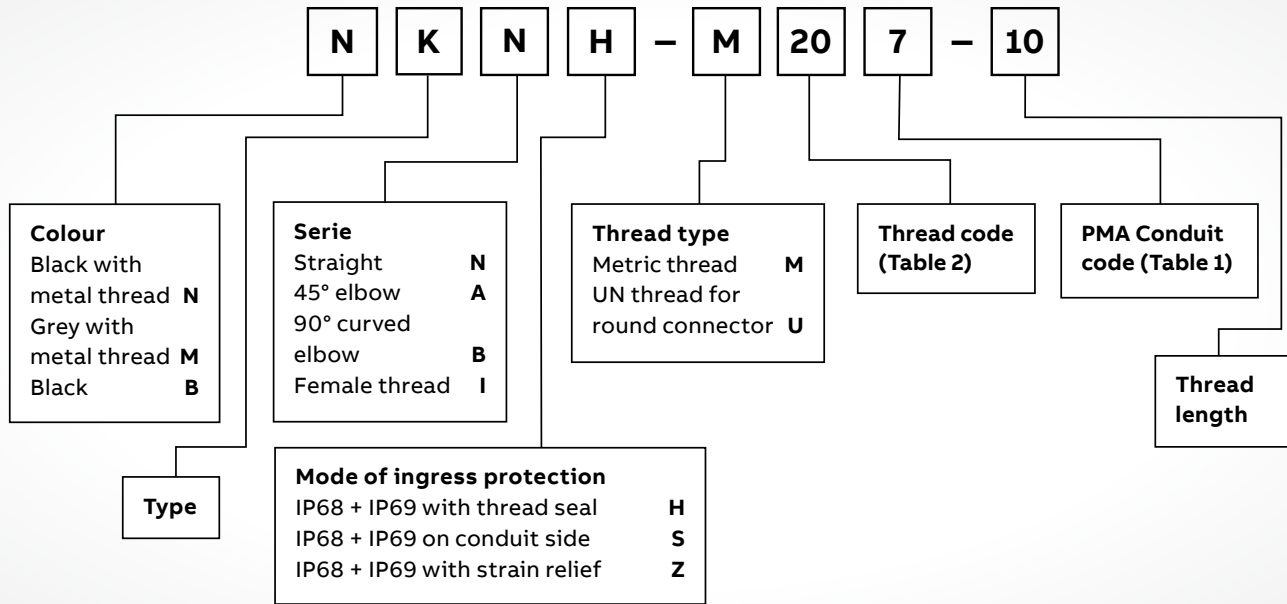

Connector series IP68 + IP69

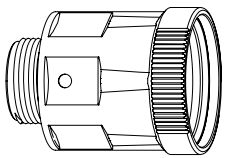

01

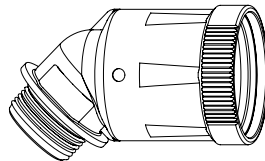

02

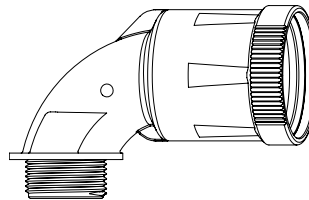

03

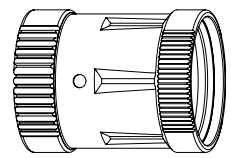

04

01 Straight (N)

02 45° elbow (A)

03 90° curved elbow (B)

04 Female thread (I)

PMAFIX Pro

Size codes, installation

Table 1: Conduit codes

Nominal width	Metric size	PMA code
10	12	0
12	16	2
17	20	7
23	25	3
29	32	9
36	40	6
48	50	8

Table 2: Thread codes

Thread Metric	PMA code
M12x1.5	M12
M16x1.5	M16
M20x1.5	M20
M25x1.5	M25
M32x1.5	M32
M40x1.5	M40
M50x1.5	M50
M63x1.5	M63

Thread UN	PMA code
7/8-20 UNEF	U21
1-20 UNEF	U24
1 1/16-18 UNEF	U29
1 7/16-18 UNEF	U35
1 3/4-18 UNS	U43
2-18 UNS	U50
2 1/4-16 UN	U56

Additional code for female thread connectors

Type	PMA code
With O-ring groove (MIL C 5015)	G

Installation IP68 + IP69

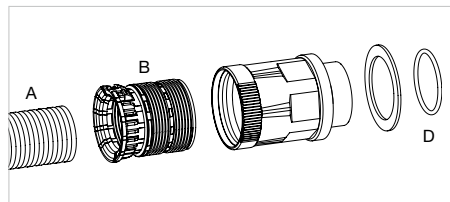

01

A = Corrugated conduit
 B = Sealing and locking element
 C = Fitting body
 D = Thread seal (O-ring or glat gasket *)

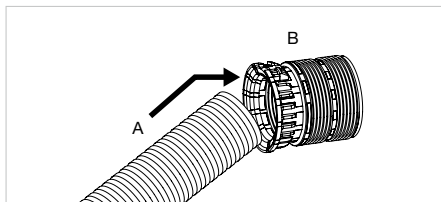

02

Place corrugated conduit (A) at a slight angle against the sealing element (B), then push right into the end.

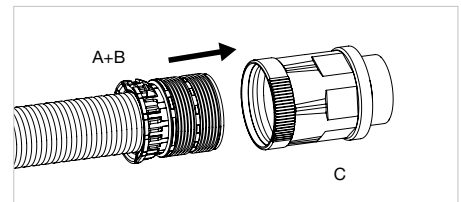

03

Push the conduit and sealing element (A+B) together into the outer body of the fitting (C). Water or a lubricating agent can help facilitate the push-in process.

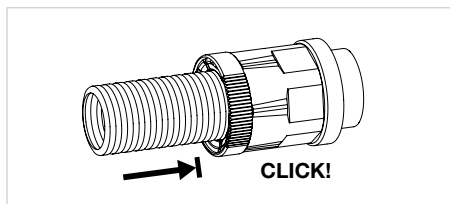

04

The locking mechanism engages when the sealing element is pushed in fully.

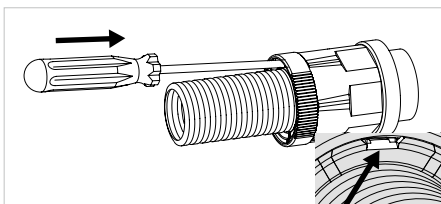

05

To disengage the locking mechanism introduce a size 1 screwdriver parallel to the conduit into the opening shown in the detail drawing.

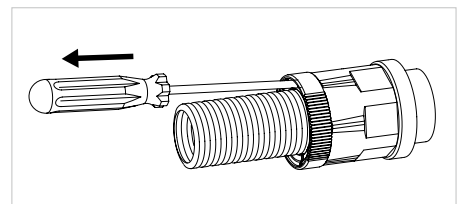

06

Pull the conduit and screwdriver out of the fitting together keeping the screwdriver parallel to the conduit.

PMAFIX Pro

Connectors metric, metal thread

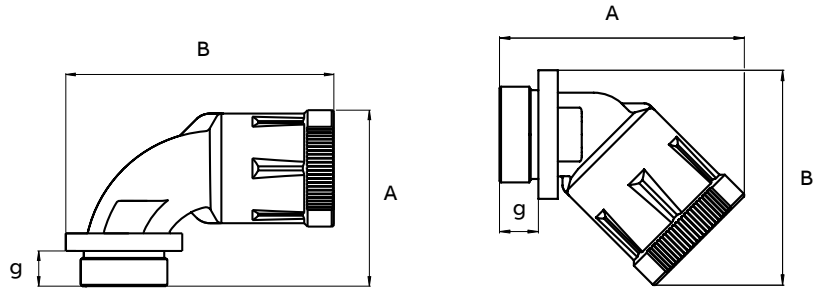

g = Thread length
A x B = External dimensions

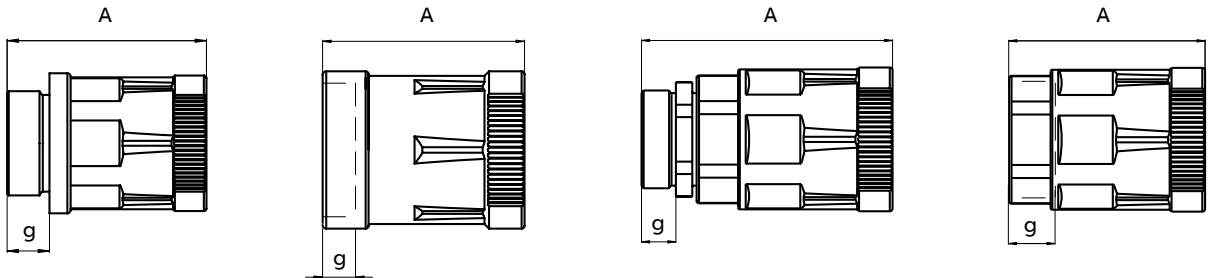

g = Thread length
A = Overall length

Type KNH - Connector straight, metric metal thread

	Order no. black IP68 + IP69	Order no. grey IP68 + IP69	Thread metric	Fits to conduit size		Thread length (mm)	Overall length (mm)
				NW	Metric		
	NKNH-M120-10	MKNH-M120-10	M12 x 1.5	10	12	10.0	45.0
	NKNH-M160-10	MKNH-M160-10	M16 x 1.5	10	12	10.0	45.0
	NKNH-M162-10	MKNH-M162-10	M16 x 1.5	12	16	10.0	50.5
	NKNH-M202-10	MKNH-M202-10	M20 x 1.5	12	16	10.0	50.5
	NKNH-M207-10	MKNH-M207-10	M20 x 1.5	17	20	10.0	56.0
	NKNH-M257-11	MKNH-M257-11	M25 x 1.5	17	20	11.0	57.0
	NKNH-M253-11	MKNH-M253-11	M25 x 1.5	23	25	11.0	59.5
	NKNH-M323-13	MKNH-M323-13	M32 x 1.5	23	25	13.0	61.5
	NKNH-M329-13	MKNH-M329-13	M32 x 1.5	29	32	13.0	67.0
	NKNH-M409-13	MKNH-M409-13	M40 x 1.5	29	32	13.0	68.5
	NKNH-M406-13	MKNH-M406-13	M40 x 1.5	36	40	13.0	74.0
	NKNH-M506-14	MKNH-M506-14	M50 x 1.5	36	40	14.0	75.0
	NKNH-M508-14	MKNH-M508-14	M50 x 1.5	48	50	14.0	81.0
	NKNH-M638-14	MKNH-M638-14	M63 x 1.5	48	50	14.0	81.0

Approvals





For applications in railway vehicles and heavy machine construction
High thread and system connection strength

Connectors metric, metal thread

Type KNZ

Type KNZ - Connector straight with strain relief, metric metal thread



	Order no. IP68 + IP69 Compl., black	Order no. fitting*	Order no. insert	Thread metric	Fits to conduit size		Terminal range (mm)	Thread length (mm)	Overall length (mm)
					NW	Metric			
KNZ, patent	NKNZ-M120/P1	NKNZ-M120R/P	EK 150/p7	M12 x 1.5	10	12	4.0–6.5	5.0	53.5
	NKNZ-M120/P2		EK 150/p8	M12 x 1.5	10	12	5.0–8.0	5.0	53.5
	NKNZ-M120/P3		EK 150/p9	M12 x 1.5	10	12	6.5–9.5	5.0	53.5
	NKNZ-M160/P1	NKNZ-M160R/P	E 150/p7	M16 x 1.5	10	12	4.0–6.5	6.0	54.5
	NKNZ-M160/P2		E 150/p8	M16 x 1.5	10	12	5.0–8.0	6.0	54.5
	NKNZ-M160/P3		E 150/p9	M16 x 1.5	10	12	6.5–9.5	6.0	54.5
	NKNZ-M202/P1	NKNZ-M202R/P	E 152/p7	M20 x 1.5	12	16	4.0–6.5	6.5	60.5
	NKNZ-M202/P3		E 152/p9	M20 x 1.5	12	16	6.5–9.5	6.5	60.5
	NKNZ-M202/P4		E 152/p11	M20 x 1.5	12	16	7.0–10.5	6.5	60.5
	NKNZ-M207/P3	NKNZ-M207R/P	E 152/p9	M20 x 1.5	17	20	6.5–9.5	6.5	66.5
	NKNZ-M207/P4		E 152/p11	M20 x 1.5	17	20	7.0–10.5	6.5	66.5
	NKNZ-M207/P5		E 152/p13	M20 x 1.5	17	20	9.0–13.0	6.5	66.5
	NKNZ-M257/P4	NKNZ-M257R/P	E 153/p11	M25 x 1.5	17	20	7.0–10.5	7.5	67.5
	NKNZ-M257/P5		E 153/p13	M25 x 1.5	17	20	9.0–13.0	7.5	67.5
	NKNZ-M257/P6		E 153/p16	M25 x 1.5	17	20	11.5–15.5	7.5	67.5
	NKNZ-M253/P5	NKNZ-M253R/P	EK 154/p13	M25 x 1.5	23	25	9.0–13.0	7.5	75.0
	NKNZ-M253/P6	NKNZ-M253R1/P	EK 154/p16	M25 x 1.5	23	25	11.5–15.5	7.5	75.0
	NKNZ-M323/P2	NKNZ-M323R/P	E 154/p13	M32 x 1.5	23	25	9.0–13.0	8.0	76.0
	NKNZ-M323/P4		E 154/p18	M32 x 1.5	23	25	14.0–18.0	8.0	76.0
	NKNZ-M323/P5	NKNZ-M323R1/P	E 154/p20	M32 x 1.5	23	25	17.0–20.5	8.0	76.0
	NKNZ-M329/P2	NKNZ-M329R/P	EK 155/p18	M32 x 1.5	29	32	14.0–18.0	8.0	83.0
	NKNZ-M329/P3		EK 155/p20	M32 x 1.5	29	32	17.0–20.5	8.0	83.0
	NKNZ-M329/P4		EK 155/p25	M32 x 1.5	29	32	20.0–25.0	8.0	83.0
	NKNZ-M409/P1	NKNZ-M409R/P	E 155/p16	M40 x 1.5	29	32	11.5–15.5	8.0	83.0
	NKNZ-M409/P2		E 155/p18	M40 x 1.5	29	32	14.0–18.0	8.0	83.0
	NKNZ-M409/P3		E 155/p20	M40 x 1.5	29	32	17.0–20.5	8.0	83.0
	NKNZ-M409/P4		E 155/p25	M40 x 1.5	29	32	20.0–25.0	8.0	83.0
	NKNZ-M409/P5		E 155/p28	M40 x 1.5	29	32	24.0–28.0	8.0	83.0
	NKNZ-M406/P1	NKNZ-M406R/P	E 156/p25HF	M40 x 1.5	36	40	20.0–25.0	9.0	87.5
	NKNZ-M406/P2		EK 156/p28	M40 x 1.5	36	40	24.0–28.0	9.0	87.5
	NKNZ-M506/P1	NKNZ-M506R/P	E 156/p32	M50 x 1.5	36	40	27.0–32.0	10.0	90.0
	NKNZ-M506/P3		E 156/p36	M50 x 1.5	36	40	32.0–36.0	10.0	90.0
	NKNZ-M508/P2	NKNZ-M508R/P	E 157/p36HF	M50 x 1.5	48	50	32.0–36.0	10.0	100.0
	NKNZ-M508/P3		E 157/p40HF	M50 x 1.5	48	50	36.0–40.0	10.0	100.0
	NKNZ-M638/P1	NKNZ-M638R/P	E 158/pm1x35	M63 x 1.5	48	50	32.0–35.0	10.0	100.0
	NKNZ-M638/P2		E 158/p44	M63 x 1.5	48	50	39.0–44.0	10.0	100.0

Approvals



* without insert

For applications in railway vehicles and heavy machine construction

For the separation of damp and dry areas

Sealing inserts are made from TPE-V

With integrated strain relief and optimal ingress protection at the cable (up to IP68/10 bar)

High thread and system connection strength

Temperature range sealing insert Pflitsch: -40°C to +135°C

Note: For several conductors multiple sealing inserts MDE are available. R/P version of fitting has to be used in combination with multiple sealing inserts

Connectors metric, metal thread

Type KNZ

Type KNZ - Connector straight with strain relief, metric long metal thread



	Order no. IP68 + IP69 Compl., black	Order no. fitting*	Order no. insert	Thread metric	Fits to conduit size		Terminal range (mm)	Thread length (mm)	Overall length (mm)
					NW	Metric			
	NKNZ-M160/P1-L	NKNZ-M160R/P-L	E 150/p7	M16 x 1.5	10	16	4.0–6.5	15.0	63.5
	NKNZ-M160/P2-L		E 150/p8	M16 x 1.5	10	16	5.0–8.0	15.0	63.5
	NKNZ-M160/P3-L		E 150/p9	M16 x 1.5	10	16	6.5–9.5	15.0	63.5
	NKNZ-M202/P1-L	NKNZ-M202R/P-L	E 152/p7	M20 x 1.5	12	20	4.0–6.5	15.0	69.0
	NKNZ-M202/P3-L		E 152/p9	M20 x 1.5	12	20	6.5–9.5	15.0	69.0
	NKNZ-M202/P4-L		E 152/p11	M20 x 1.5	12	20	7.0–10.5	15.0	69.0
	NKNZ-M207/P3-L	NKNZ-M207R/P-L	E 152/p9	M20 x 1.5	17	20	6.5–9.5	15.0	75.0
	NKNZ-M207/P4-L		E 152/p11	M20 x 1.5	17	20	7.0–10.5	15.0	75.0
	NKNZ-M207/P5-L		E 152/p13	M20 x 1.5	17	20	9.0–13.0	15.0	75.0
	NKNZ-M257/P5-L	NKNZ-M257R/P-L	E 153/p13	M25 x 1.5	17	25	9.0–13.0	15.0	75.0
	NKNZ-M257/P6-L		E 153/p16	M25 x 1.5	17	25	11.5–15.5	15.0	75.0
	NKNZ-M323/P2-L	NKNZ-M323R/P-L	E 154/p13	M32 x 1.5	23	32	9.0–13.0	15.0	83.0
	NKNZ-M323/P4-L		E 154/p18	M32 x 1.5	23	32	14.0–18.0	15.0	83.0
	NKNZ-M323/P5-L	NKNZ-M323R1/P-L	E 154/p20	M32 x 1.5	23	32	17.0–20.5	15.0	83.0
	NKNZ-M329/P2-L	NKNZ-M329R/P-L	EK 155/p18	M32 x 1.5	29	32	14.0–18.0	15.0	90.0
	NKNZ-M329/P3-L		EK 155/p20	M32 x 1.5	29	40	17.0–20.5	15.0	90.0
	NKNZ-M409/P3-L	NKNZ-M409R/P-L	E 155/p20	M40 x 1.5	29	40	17.0–20.5	15.0	90.0
	NKNZ-M409/P4-L		E 155/p25	M40 x 1.5	29	40	20.0–25.0	15.0	90.0
	NKNZ-M409/P5-L		E 155/p28	M40 x 1.5	29	50	24.0–28.0	15.0	90.0
	NKNZ-M506/P1-L	NKNZ-M506R/P-L	E 156/p32	M50 x 1.5	36	50	27.0–32.0	15.0	95.0
NKNZ-M506/P3-L		E 156/p36	M50 x 1.5	36	50	32.0–36.0	15.0	95.0	
NKNZ-M508/P2-L	NKNZ-M508R/P-L	E 157/p36HF	M50 x 1.5	48	50	32.0–36.0	15.0	105.0	
NKNZ-M508/P3-L		E 157/p40HF	M50 x 1.5	48	50	36.0–40.0	15.0	105.0	
NKNZ-M638/P1-L	NKNZ-M638R/P-L	E 158/pm1x35	M63 x 1.5	48	63	32.0–35.0	15.0	105.0	
NKNZ-M638/P2-L		E 158/p44	M63 x 1.5	48	63	39.0–44.0	15.0	105.0	

c
R[®]
US

Approvals



* without insert

For applications in railway vehicles and heavy machine construction

For the separation of damp and dry areas

Sealing inserts are made from TPE-V

With integrated strain relief and optimal ingress protection at the cable (up to IP68/10 bar)

High thread and system connection strength

Temperature range sealing insert Pflitsch: -40°C to +135°C

Note: For several conductors multiple sealing inserts MDE are available. R/P version of fitting has to be used in combination with multiple sealing inserts

Connectors metric, metal thread

Type KAH & KBH

Type KAH - Connector 45° elbow, metric metal thread

	Order no. black IP68 + IP69	Order no. grey IP68 + IP69	Thread metric	Fits to conduit size		Thread length (mm)	External dimensions (mm)
				NW	Metric		
	NKAH-M120-10	MKAH-M120-10	M12 x 1.5	10	12	10.0	55.5 x 43.0
	NKAH-M160-10	MKAH-M160-10	M16 x 1.5	10	12	10.0	55.5 x 45.0
	NKAH-M162-10	MKAH-M162-10	M16 x 1.5	12	16	10.0	62.5 x 50.0
	NKAH-M202-10	MKAH-M202-10	M20 x 1.5	12	16	10.0	62.5 x 52.0
	NKAH-M207-10	MKAH-M207-10	M20 x 1.5	17	20	10.0	71.0 x 59.5
	NKAH-M257-11	MKAH-M257-11	M25 x 1.5	17	20	11.0	72.0 x 62.5
	NKAH-M253-11	MKAH-M253-11	M25 x 1.5	23	25	11.0	80.0 x 68.0
	NKAH-M323-13	MKAH-M323-13	M32 x 1.5	23	25	13.0	82.0 x 72.0
	NKAH-M329-13	MKAH-M329-13	M32 x 1.5	29	32	13.0	93.0 x 79.5
	NKAH-M409-13	MKAH-M409-13	M40 x 1.5	29	32	13.0	94.5 x 85.5
	NKAH-M406-13	MKAH-M406-13	M40 x 1.5	36	40	13.0	105.5 x 93.5
	NKAH-M506-14	MKAH-M506-14	M50 x 1.5	36	40	14.0	106.5 x 98.5
	NKAH-M508-14	MKAH-M508-14	M50 x 1.5	48	50	14.0	120.0 x 111.0
	NKAH-M638-14	MKAH-M638-14	M63 x 1.5	48	50	14.0	120.0 x 114.0

Approvals



For applications in railway vehicles and heavy machine construction
High thread and system connection strength

Type KBH - Connector 90° curved elbow, metric metal thread

	Order no. black IP68 + IP69	Order no. grey IP68 + IP69	Thread metric	Fits to conduit size		Thread length (mm)	External dimensions (mm)
				NW	Metric		
	NKBH-M120-10	MKBH-M120-10	M12 x 1.5	10	12	10.0	44.0 x 62.5
	NKBH-M160-10	MKBH-M160-10	M16 x 1.5	10	12	10.0	44.0 x 64.5
	NKBH-M162-10	MKBH-M162-10	M16 x 1.5	12	16	10.0	47.5 x 72.0
	NKBH-M202-10	MKBH-M202-10	M20 x 1.5	12	16	10.0	47.5 x 74.0
	NKBH-M207-10	MKBH-M207-10	M20 x 1.5	17	20	10.0	53.0 x 81.0
	NKBH-M257-11	MKBH-M257-11	M25 x 1.5	17	20	11.0	54.0 x 84.0
	NKBH-M253-11	MKBH-M253-11	M25 x 1.5	23	25	11.0	63.0 x 92.0
	NKBH-M323-13	MKBH-M323-13	M32 x 1.5	23	25	13.0	65.0 x 96.0
	NKBH-M329-13	MKBH-M329-13	M32 x 1.5	29	32	13.0	75.0 x 108.0
	NKBH-M409-13	MKBH-M409-13	M40 x 1.5	29	32	13.0	76.5 x 114.0
	NKBH-M406-13	MKBH-M406-13	M40 x 1.5	36	40	13.0	87.5 x 126.0
	NKBH-M506-14	MKBH-M506-14	M50 x 1.5	36	40	14.0	88.5 x 131.0
	NKBH-M508-14	MKBH-M508-14	M50 x 1.5	48	50	14.0	101.0 x 145.5
	NKBH-M638-14	MKBH-M638-14	M63 x 1.5	48	50	14.0	101.0 x 148.5

Approvals



For applications in railway vehicles and heavy machine construction
High thread and system connection strength
Smooth elbow allows easy threading of wires and cables

Connectors, female polyamide UNEF thread

Type KIHG

Type KIHG - Connector straight, UN female thread for MIL-C5015

	Order no. black IP68 + IP69	Thread UN	Shell size MIL	Fits to conduit size		Thread length (mm)	Overall length (mm)
				NW	Metric		
KIHG, patent 	BKIHG-U212	7/8"-20 UNEF	16	12	16	9.0	47.0
	BKIHG-U217	7/8"-20 UNEF	16	17	20	9.0	52.5
	BKIHG-U242	1"-20 UNEF	18	12	16	9.0	47.0
	BKIHG-U247	1"-20 UNEF	18	17	20	9.0	52.5
	BKIHG-U243	1"-20 UNEF	18	23	23	9.0	55.5
	BKIHG-U292	1 3/16"-18 UNEF	20	12	16	9.0	50.5
	BKIHG-U297	1 3/16"-18 UNEF	20	17	20	9.0	52.5
	BKIHG-U293	1 3/16"-18 UNEF	20	23	25	9.0	55.5
	BKIHG-U299	1 3/16"-18 UNEF	20	29	32	9.0	61.0
	BKIHG-U357	1 7/16"-18 UNEF	24	17	20	9.0	58.0
	BKIHG-U353	1 7/16"-18 UNEF	24	23	25	9.0	55.5
	BKIHG-U359	1 7/16"-18 UNEF	24	29	32	9.0	61.0
	BKIHG-U433	1 3/4"-18 UNS	32	23	25	10.0	62.5
	BKIHG-U439	1 3/4"-18 UNS	32	29	32	10.0	62.0
	BKIHG-U503	2"-18 UNS	36	23	25	10.0	67.0
	BKIHG-U509	2"-18 UNS	36	29	32	10.0	67.5
	BKIHG-U506	2"-18 UNS	36	36	40	10.0	67.0
	BKIHG-U508	2"-18 UNS	36	48	50	10.0	73.5
BKIHG-U566	2 3/4"-16 UN	40	36	40	10.0	72.0	
BKIHG-U568	2 3/4"-16 UN	40	48	50	10.0	73.5	

Approvals



For applications in railway vehicles and heavy machine construction
Suitable for MIL connector, series C5015

Connectors metric, female metal thread (sealing elements)

Type KIS & KNH2

Type KIS - Connector straight, metric metal female thread

	Order no. black IP68 + IP69	Thread metric	Fits to conduit size		Thread length (mm)	Overall length (mm)
			NW	Metric		
	NKIS-M162	M16 x 1.5	12	16	9.0	49.0
	NKIS-M207	M20 x 1.5	17	20	10.5	56.0
	NKIS-M253	M25 x 1.5	23	25	10.5	58.5
	NKIS-M329	M32 x 1.5	29	32	11.0	65.5
	NKIS-M406	M40 x 1.5	36	40	13.5	72.0
	NKIS-M508	M50 x 1.5	48	50	15.0	83.0
	NKIS-M638	M63 x 1.5	48	50	17.5	84.0

Approvals



For applications in railway vehicles and heavy machine construction
High thread and system connection strength
No seal on female thread side

Type KNH2 - PMAFIX Pro sealing and locking element

	Order no.	Fits to conduit size		Outside Ø (mm)	Overall length (mm)
		NW	Metric		
	KNH2-NW10	10	12	22.0	28.0
	KNH2-NW12	12	16	25.5	33.5
	KNH2-NW17	17	20	31.5	38.5
	KNH2-NW23	23	25	38.5	41.0
	KNH2-NW29	29	32	46.5	46.5
	KNH2-NW36	36	40	55.5	50.5
	KNH2-NW48	48	50	68.0	56.5

Connectors nylon straight fitting

Type JKNH

Type JKNH - Connector two-piece, straight, IP69, metric thread

	Order no. black	Thread size metric	Fits to conduit size NW	Dimensions					Weight kg/100 pcs	Packing unit/pcs
				g (mm)	Ø ID (mm)	Ø D (mm)	L max. (mm)	sw (mm)		
	JKNH-M162	M16 x 1.5	12	11.0	11.0	28.5	47.5	25	0.8	10
	JKNH-M202	M20 x 1.5	12	12.5	11.0	28.5	47.5	25	0.9	10
	JKNH-M207	M20 x 1.5	17	14.5	11.0	35.0	53.5	32	1.4	10
	JKNH-M257	M25 x 1.5	17	16.5	12.0	35.0	54.5	32	1.5	10
	JKNH-M253	M25 x 1.5	23	19.0	12.0	42.0	57.0	38	1.7	10
	JKNH-M323	M32 x 1.5	23	23.0	15.0	43.0	60.5	38	2.0	10
	JKNH-M329	M32 x 1.5	29	26.0	15.0	51.5	65.5	46	3.2	10
	JKNH-M409	M40 x 1.5	29	29.0	19.0	51.5	69.5	46	3.7	10
	JKNH-M406	M40x1.5	36	32.0	19.0	65.0	75.0	60	5.9	10
	JKNH-M506	M50 x 1.5	36	37.5	19.0	65.0	75.0	60	6.2	10
	JKNH-M508	M50 x 1.5	48	42.0	19.0	75.0	81.0	70	7.5	10
	JKNH-M638	M63 x 1.5	48	48.5	19.0	75.0	81.0	70	7.8	10

Approvals



Very high impact resistance - easy push-in assembly
Corrosion-free
Excellent conduit pull-out strength
IP69 system protection for indoor splash zone areas

PMAFIX IP66, IP68 (IP69)

General technical details

PMAFIX connectors. The designation PMAFIX describes a very large range of connectors for PMA conduit with the patented PMA safety clip system.

Connectors are available for ingress protection IP66 and IP68. IP66 connectors are fitted with a pre-installed universal safety clip which ensures a quick “push-in” installation. IP68 connectors for increased requirements will be delivered with a special conduit seal cap. The new PMAFIX IP68GT fittings combine simplest push-in assembly with highest sealing performance. It is also possible to upgrade to IP69 by retrofitting water impact protection.

Material

- Fittings made from specially formulated polyamide 6
- Threads made from nickel-plated brass or polyamide 6
- Self-extinguishing
- Free from halogens, REACH + RoHS compliant
- Very good chemical properties
- Temperature range: -40°C to +105°C, short-term to +160°C

Characteristics

- Excellent conduit pull-out strength
- High impact resistance
- Vibration-proof connection to PMA corrugated conduit
- Fits conduit profiles – fine (T) and coarse (G)
- To avoid accidental opening, disassembly is only possible with a screwdriver





PMAFIX

General technical details



—
Patent



—
Patent



—
Patent

IP66

IP66 static

IP54 dynamic

- One piece fitting
- Conical sealing method
- Easy "push-in" installation
- Pre-installed safety clip AFN2
- Content of delivery: Connector with pre-installed safety clip

IP68GT

IP68 static

IP67 dynamic

IP69 according to IEC 60529

- The single piece PMAFIX IP68GT fitting with integrated sealing cap and pre-installed locking clip
- Simple push-in assembly (as with the proven PMAFIX IP66 system)
- The extra long sealing cap guarantees the highest level of ingress protection
- Identical approvals as for the PMAFIX IP68 system component version
- Fast modification of specification drawings through simple addition of "GT" to the existing order number (e.g. BVNV-M257 → BVNV-M257GT)
- Additional water protection ring WPS for IP69 ingress protection in conjunction with the IP68 system to be applied right after the IP68 connector onto the conduit
- Content of delivery: Connector with integrated sealing cap, pre-installed safety clip and thread seal for male thread (O-ring and/or flat gasket)

IP68

IP68 static

IP67 dynamic

IP69 according to IEC 60529

- High sealing through additional seal cap
- For highest dynamic applications
- Additional water protection ring WPS for IP69 ingress protection in conjunction with the IP68 system to be applied right after the IP68 connector onto the conduit
- Content of delivery: Connector with sealing cap, safety clip and thread seal for male thread (O-ring and/or flat gasket)

PMAFIX

Part number codes

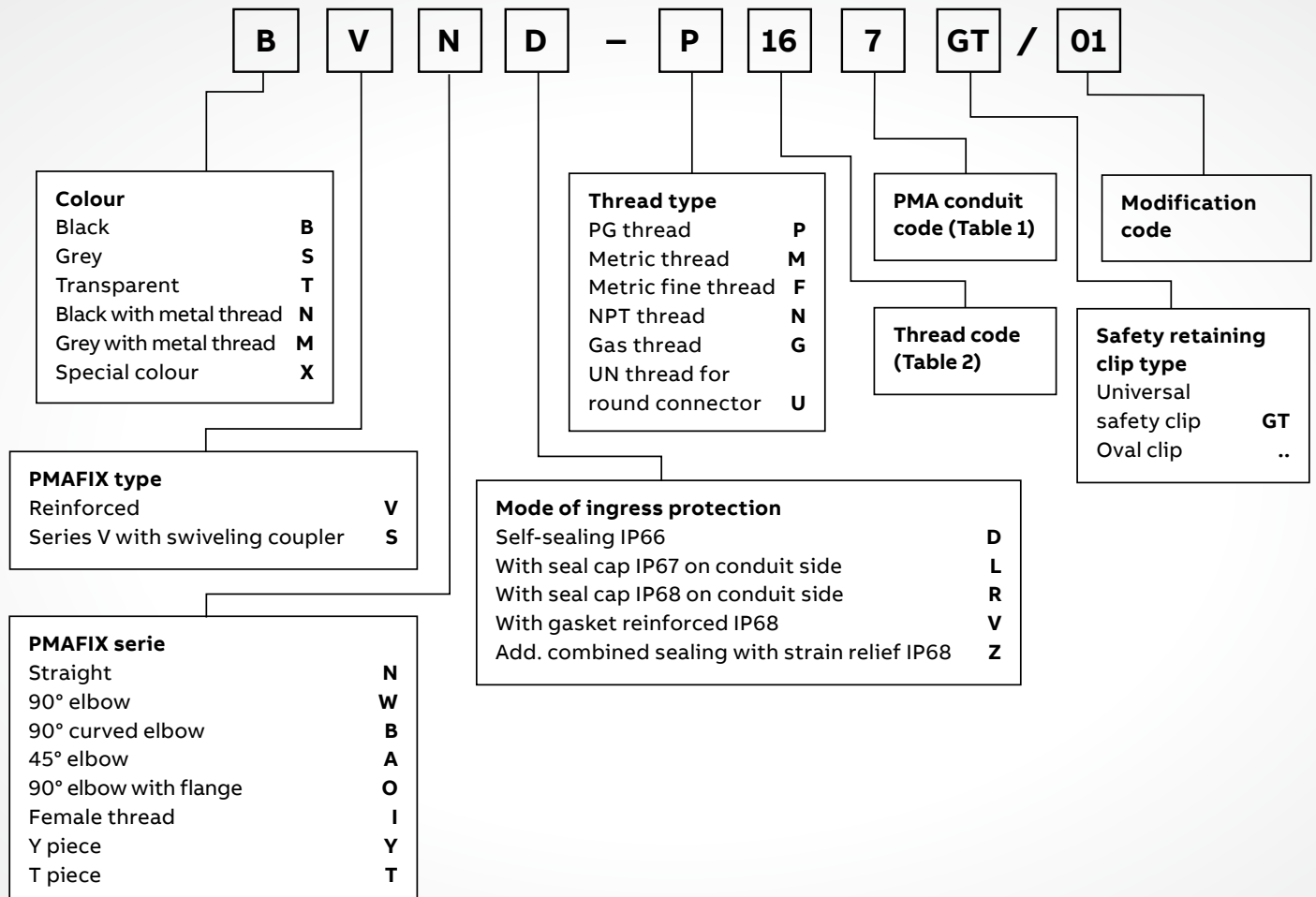

Connector series

- 01 Serie N
- 02 Serie W
- 03 Serie B
- 04 Serie A
- 05 Serie O
- 06 Serie I
- 07 Serie Y
- 08 Serie T

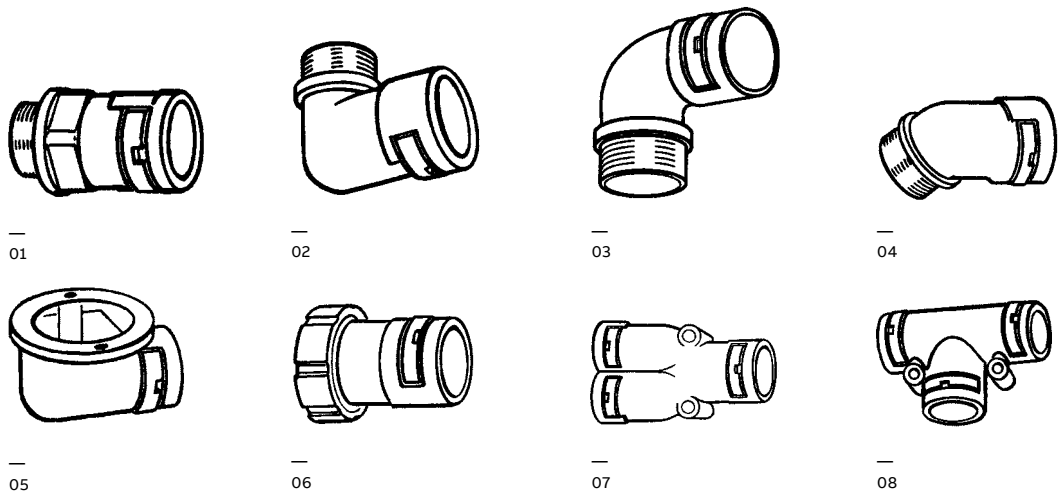

PMAFIX

Size codes

Table 1: Conduit codes

Nominal width	Metric size	PMA code
07	10	M
10	12	0
12	16	2
17	20	7
23	25	3
29	32	9
36	40	6
48	50	8

Additional code for female thread connectors

Type	PMA code
AMP	A
Souriau (ex Burndy) UTG 6	B
With O-ring groove (MIL C 5015)	G
Souriau UTO/UTS	S

Table 2: Thread codes

Thread metric	PMA code	Thread PG	PMA code	Thread Gas	PMA code	Thread NPT	PMA code	Thread UN	PMA code
		PG07	P07	G ¼	G00				
M12 x 1.5	M12	PG09	P09	G ⅜	G01				
M16 x 1.5	M16	PG11	P11	G ½	G02	N ½	N02	½-28 UNEF	U12
M20 x 1.5	M20	PG13.5	P13	G ¾	G04	N ¾	N04	9/16-24 UNEF	U13
		PG16	P16	G 1	G06	N 1	N06	5/8-24 UNEF	U15
M25 x 1.5	M25	PG21	P21	G 1¼	G07	N 1¼	N07	1½/16-24 UNEF	U16
M32 x 1.5	M32	PG29	P29	G 1½	G08	N 1½	N08	¾-20 UNEF	U18
M40 x 1.5	M40	PG36	P36	G 2	G09	N 2	N09	1¾/16-20 UNEF	U20
M50 x 1.5	M50	PG42	P42	G 2¼	G10			7/8-20 UNEF	U21
M63 x 1.5	M63	PG48	P48	G 2½	G11			15/16-20 UNEF	U23
								1-20 UNEF	U24
								1¼/16-18 UNEF	U26
M 8 x 1.0	F08							13/16-18 UNEF	U29
M12 x 1.0	F12							1¼-18 UNEF	U30
M18 x 1.0	F18							15/16-18 UNEF	U32
								13/8-18 UNEF	U34
								17/16-18 UNEF	U35
								15/8-18 UNEF	U40
								1¾-18 UNS	U43
								2-18 UNS	U50
								2¼-16 UN	U56
								23/8-12 UN	U57
								2½-12 UN	U62

PMAFIX Installation

Installation IP66

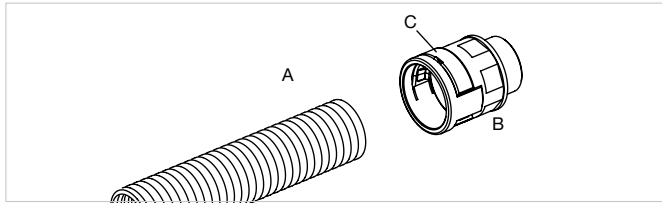

01

A = Conduit
B = Fitting
C = Universal safety clip

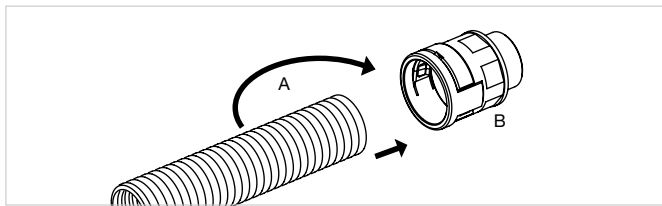

02

Push in the conduit (A) with a slight twist until the stop.

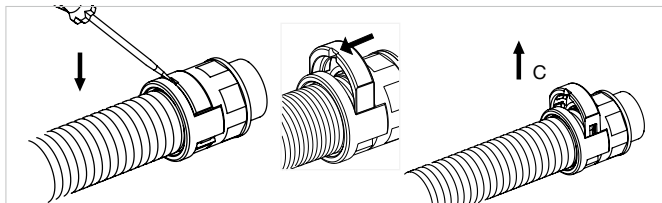

03

To re-open use a screwdriver.
The screwdriver slot in the oval clip (C) should be on the conduit side.

Locking clip pre-installed in all IP66 connectors.

* Ensure to follow
O-ring manufacturers
guidelines when
using O-rings for
sealing purposes.

Installation IP68GT

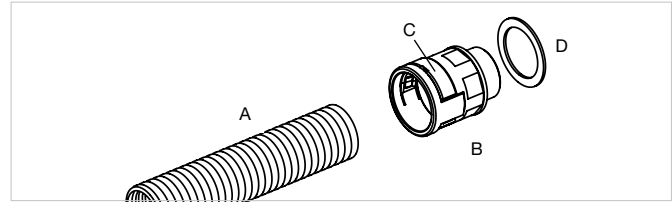

01

A = Conduit
B = Fitting with integrated sealing cap
C = Universal safety clip
D = Thread seal (either O-ring or flat gasket*, not both)

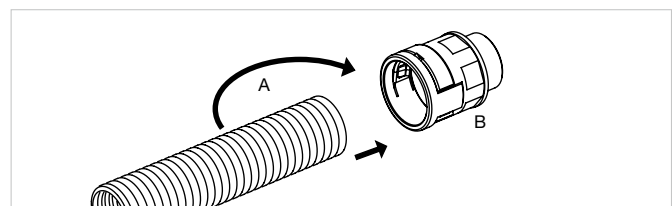

02

Push in the conduit (A) right into the end of the fitting (B) with a slight twist. Additional insertion resistance will be felt when the end of the fitting has been reached.

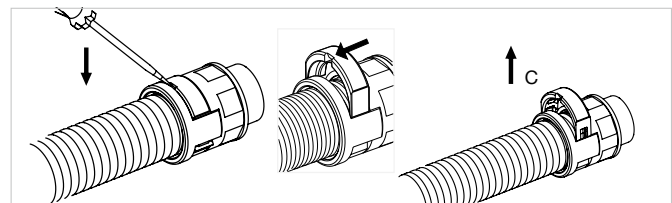

03

To re-open use a screwdriver.
The screwdriver slot in the oval clip (C) should be on the conduit side.

Pre-installed sealing cap and locking clip in all
IP68GT connectors.

PMAFIX

Installation

Installation IP68 (IP69)

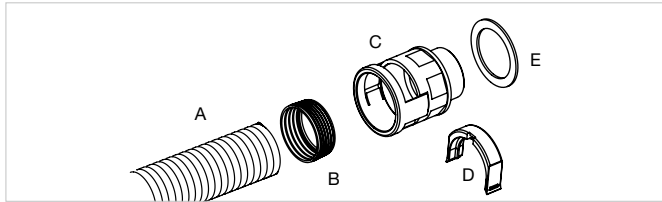

01

- A = Conduit
- B = Sealing cap
- C = Fitting
- D = Oval clip
- E = Thread seal (O-ring or flat seal*)

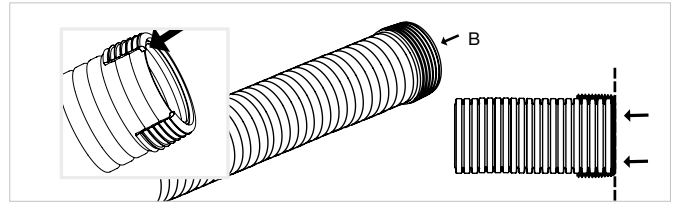

02

Push sealing cap (B) completely onto the conduit in order to achieve IP68.

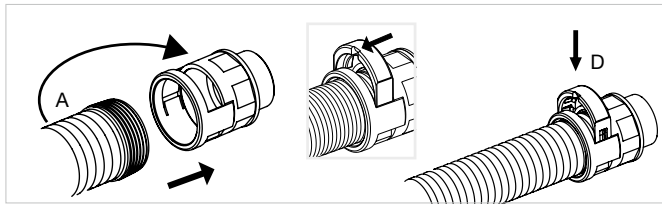

03

Push in the conduit (A) with a slight twist until the stop. Insert oval clip (D) in the locking element window and click into place. Screwdriver slot in the oval clip should be on conduit side.

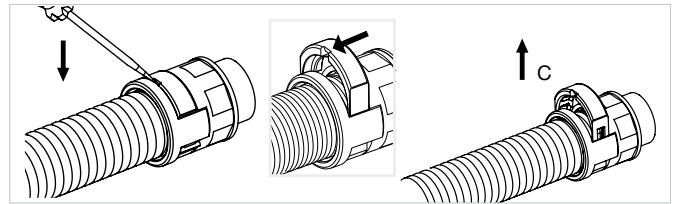

04

To re-open use a screwdriver.

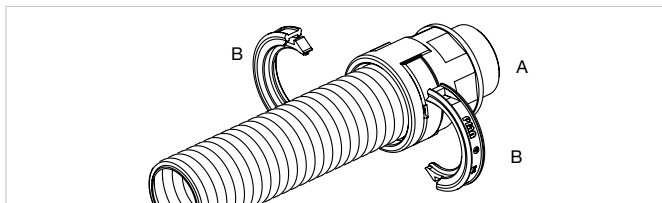

05

- For IP69:
- Based on IP68 System
- A = Conduit with IP68 fitting
- B = WPS half shells

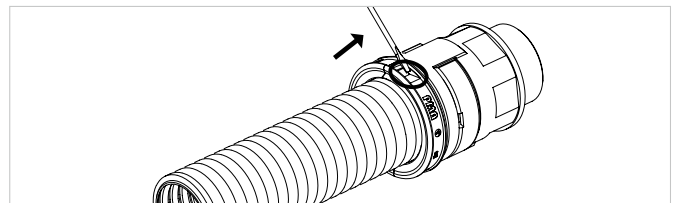

06

To re-open use a screwdriver.

* For safety reasons, oval clip will not fit if seal cap is not fully installed.

Ensure to follow O-ring manufacturers guidelines when using O-rings for sealing purposes.

PMAFIX

Connectors metric, polyamide thread

Installation IP66

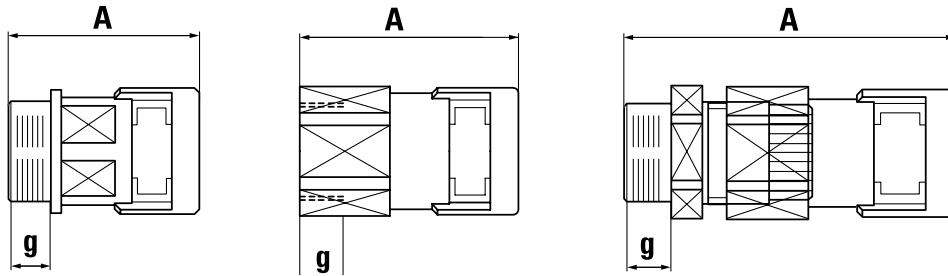

g = Thread length
A = Overall length

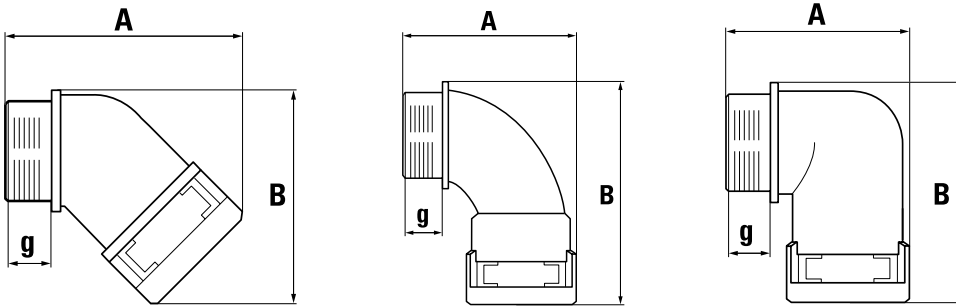

g = Thread length
A x B = External dimensions

Type VN - Connector straight, metric thread

	Order no. IP66 ①	Order no. IP68* ① ②	Thread metric	Fits to conduit size		Thread length (mm)	Overall length (mm)
				NW	Metric		
	BVND-M12MGT	BVNV-M12M	M12 x 1.5	07	10	11.0	34.5
	BVND-M120GT	BVNV-M120	M12 x 1.5	10	12	11.0	36.5
	BVND-M160GT	BVNV-M160	M16 x 1.5	10	12	11.0	36.5
	BVND-M162GT	BVNV-M162	M16 x 1.5	12	16	11.0	39.5
	BVND-M200GT	BVNV-M200	M20 x 1.5	10	12	11.0	36.5
	BVND-M202GT	BVNV-M202	M20 x 1.5	12	16	11.0	39.5
	BVND-M207GT	BVNV-M207	M20 x 1.5	17	20	11.0	47.5
	BVND-M203GT	BVNV-M203	M20 x 1.5	23	25	11.0	51.0
	BVND-M257GT	BVNV-M257	M25 x 1.5	17	20	12.0	48.5
	BVND-M253GT	BVNV-M253	M25 x 1.5	23	25	12.0	52.0
	BVND-M323GT	BVNV-M323	M32 x 1.5	23	25	15.0	55.5
	BVND-M329GT	BVNV-M329	M32 x 1.5	29	32	15.0	56.0
	BVND-M409GT	BVNV-M409	M40 x 1.5	29	32	19.0	60.0
	BVND-M406GT	BVNV-M406	M40 x 1.5	36	40	19.0	72.5
	BVND-M506GT	BVNV-M506	M50 x 1.5	36	40	19.0	72.0
	BVND-M508GT	BVNV-M508	M50 x 1.5	48	50	19.0	72.5
	BVND-M638GT	BVNV-M638	M63 x 1.5	48	50	19.0	72.0

Approvals



For cable protection systems in a wide range of applications

- ① Please replace "B" for black with "S" for grey in front of the order no.
- ② IP68GT available. Please add "GT" after the order no.

Connectors metric, polyamide thread

Type VNDZ/VNZ & VA

Type VNDZ/VNZ - Connector straight with strain relief, metric thread

	Order no. IP66 ①	Order no. IP68 ① ③	Thread metric	Fits to conduit size		Terminal range	Thread length (mm)	Overall length (mm)
				NW	Metric			
	BVNDZ-M160GT	–	M16 x 1.5	10	12	5.0–10.0	8.0	62.0
	BVNDZ-M162GT	BVNZ-M162S	M16 x 1.5	12	16	5.0–10.0	8.0	62.0
	BVNDZ-M207GT	BVNZ-M207S	M20 x 1.5	17	20	10.0–14.0	8.0	72.0
	BVNDZ-M253GT	BVNZ-M253S	M25 x 1.5	23	25	13.0–18.0	8.0	81.0
	BVNDZ-M329GT	BVNZ-M329S	M32 x 1.5	29	32	18.0–25.0	10.0	85.0
	BVNDZ-M406GT	BVNZ-M406S	M40 x 1.5	36	40	22.0–32.0	10.0	108.5
	BVNDZ-M508GT	BVNZ-M508S	M50 x 1.5	48	50	30.0–38.0	12.0	119.5
	BVNDZ-M638GT	BVNZ-M638S	M63 x 1.5	48	50	34.0–44.0	12.0	119.5

For machine and plant construction

For separation of damp and dry areas

Integrated strain relief optimally holds and seals cables

If several conductors are used with the connector multiple sealing inserts should be considered

Note: For several conductors multiple sealing inserts MDE are available

Type VA - Connector 45° elbow, metric thread

	Order no. IP66 ①	Order no. IP68 ① ②	Thread metric	Fits to conduit size		Thread length (mm)	Overall length (mm)
				NW	Metric		
	BVAD-M120GT	–	M12 x 1.5	10	12	11.0	43.5 x 37.0
	BVAD-M160GT	BVAV-M160	M16 x 1.5	10	12	11.0	43.5 x 38.0
	BVAD-M162GT	BVAV-M162	M16 x 1.5	12	16	11.0	48.0 x 40.0
	BVAD-M202GT	BVAV-M202	M20 x 1.5	12	16	11.0	48.0 x 41.5
	BVAD-M207GT	BVAV-M207	M20 x 1.5	17	20	11.0	55.5 x 51.5
	BVAD-M253GT	BVAV-M253	M25 x 1.5	23	25	12.0	65.0 x 58.5
	BVAD-M329GT	BVAV-M329	M32 x 1.5	29	32	15.0	73.5 x 66.5
	BVAD-M406GT	BVAV-M406	M40 x 1.5	36	40	19.0	92.5 x 85.5
	BVAD-M506GT	BVAV-M506	M50 x 1.5	36	40	19.0	92.5 x 89.5
	BVAD-M508GT	BVAV-M508	M50 x 1.5	48	50	19.0	100.0 x 96.0
	BVAD-M638GT	BVAV-M638	M63 x 1.5	48	50	19.0	100.0 x 104.0

Approvals



① Please replace "B" for black with "S" for grey in front of the order no.

② IP68GT available. Please add "GT" after the order no.

③ IP68GT available. Please replace "S" at the end with "GT" (e.g. BVNZ-M207GT)

Connectors metric, polyamide thread

Type VB & VW

Type VB - Connector 90° curved elbow, metric thread

	Order no. IP66 ①	Order no. IP68 ① ②	Thread metric	Fits to conduit size		Thread length (mm)	External dimensions (mm)
				NW	Metric		
	BVBD-M207GT	BVBV-M207	M20 x 1.5	17	20	11.0	47.5 x 73.0
	BVBD-M257GT	BVBV-M257	M25 x 1.5	17	20	12.0	48.5 x 76.0
	BVBD-M253GT	BVBV-M253	M25 x 1.5	23	25	12.0	57.5 x 83.0
	BVBD-M323GT	BVBV-M323	M32 x 1.5	23	25	15.0	61.0 x 87.5
	BVBD-M329GT	BVBV-M329	M32 x 1.5	29	32	15.0	70.5 x 93.0
	BVBD-M409GT	BVBV-M409	M40 x 1.5	29	32	19.0	74.5 x 98.5
	BVBD-M406GT	BVBV-M406	M40 x 1.5	36	40	19.0	85.0 x 121.0
	BVBD-M506GT	BVBV-M506	M50 x 1.5	36	40	19.0	85.0 x 125.0
	BVBD-M508GT	BVBV-M508	M50 x 1.5	48	50	19.0	98.5 x 130.0
	BVBD-M638GT	BVBV-M638	M63 x 1.5	48	50	19.0	98.5 x 138.0

Approvals



For cable protection systems in a wide range of applications
Smooth elbow allows easy threading of wires and cables

Note: For smaller conduit sizes NW 10 to NW 12 appropriate standard elbows of type VW are also available

Type VW - Connector 90° elbow, metric thread

	Order no. IP66 ①	Order no. IP68 ① ②	Thread metric	Fits to conduit size		Thread length (mm)	External dimensions (mm)
				NW	Metric		
	BVWD-M12MGT	BVWV-M12M	M12 x 1.5	07	10	11.0	32.0 x 35.0
	BVWD-M120GT	BVWV-M120	M12 x 1.5	10	12	11.0	34.0 x 39.5
	BVWD-M160GT	BVWV-M160	M16 x 1.5	10	12	11.0	34.0 x 40.5
	BVWD-M162GT	BVWV-M162	M16 x 1.5	12	16	11.0	38.5 x 46.0
	BVWD-M200GT	–	M20 x 1.5	10	12	11.0	34.0 x 42.5
	BVWD-M202GT	BVWV-M202	M20 x 1.5	12	16	11.0	38.5 x 47.5
	BVWD-M207GT	BVWV-M207	M20 x 1.5	17	20	11.0	43.5 x 58.5
	BVWD-M253GT	BVWV-M253	M25 x 1.5	23	25	12.0	54.0 x 65.0
	BVWD-M329GT	BVWV-M329	M32 x 1.5	29	32	15.0	64.5 x 73.0
	BVWD-M406GT	BVWV-M406	M40 x 1.5	36	40	19.0	78.0 x 96.0
	BVWD-M508GT	BVWV-M508	M50 x 1.5	48	50	19.0	91.5 x 106.0

Approvals



For cable protection systems in a wide range of applications

Note: For sizes NW 17 to NW 48 curved elbows of type VB are also available

① Please replace "B" for black with "S" for grey in front of the order no.

② IP68GT available. Please add "GT" after the order no.

Connectors metric, metal thread

Type VNV

Type VNV - Connector straight, NPT metal thread

	Order no. IP68, black ⁴	Order no. IP68, grey ⁴	Thread metric	Fits to conduit size		Thread length (mm)	Overall length (mm)
				NW	Metric		
	NVNV-M120-10	MVNV-M120-10	M12 x 1.5	10	12	10.0	40.0
	NVNV-M120-5	MVNV-M120-5	M12 x 1.5	10	12	5.0	35.0
	NVNV-M160-10	MVNV-M160-10	M16 x 1.5	10	12	10.0	40.0
	NVNV-M160-5	MVNV-M160-5	M16 x 1.5	10	12	5.0	35.0
	NVNV-M162-10	MVNV-M162-10	M16 x 1.5	12	16	10.0	43.0
	NVNV-M162-5	MVNV-M162-5	M16 x 1.5	12	16	5.0	38.0
	NVNV-M202-10	MVNV-M202-10	M20 x 1.5	12	16	10.0	43.0
	NVNV-M202-6	MVNV-M202-6	M20 x 1.5	12	16	6.0	39.0
	NVNV-M207-10	MVNV-M207-10	M20 x 1.5	17	20	10.0	51.0
	NVNV-M207-6	MVNV-M207-6	M20 x 1.5	17	20	6.0	47.0
	NVNV-M257-11	MVNV-M257-11	M25 x 1.5	17	20	11.0	52.0
	NVNV-M257-7	MVNV-M257-7	M25 x 1.5	17	20	7.0	48.0
	NVNV-M253-11	MVNV-M253-11	M25 x 1.5	23	25	11.0	54.0
	NVNV-M253-7	MVNV-M253-7	M25 x 1.5	23	25	7.0	50.0
	NVNV-M323-13	MVNV-M323-13	M32 x 1.5	23	25	13.0	56.0
	NVNV-M323-8	MVNV-M323-8	M32 x 1.5	23	25	8.0	51.0
	NVNV-M329-13	MVNV-M329-13	M32 x 1.5	29	32	13.0	57.3
	NVNV-M329-8	MVNV-M329-8	M32 x 1.5	29	32	8.0	52.3
	NVNV-M409-13	MVNV-M409-13	M40 x 1.5	29	32	13.0	57.3
	NVNV-M409-8	MVNV-M409-8	M40 x 1.5	29	32	8.0	52.3
	NVNV-M406-13	MVNV-M406-13	M40 x 1.5	36	40	13.0	71.4
	NVNV-M406-8	MVNV-M406-8	M40 x 1.5	36	40	8.0	66.4
	NVNV-M506-14	MVNV-M506-14	M50 x 1.5	36	40	14.0	72.4
	NVNV-M506-9	MVNV-M506-9	M50 x 1.5	36	40	9.0	67.4
	NVNV-M508-14	MVNV-M508-14	M50 x 1.5	48	50	14.0	72.4
	NVNV-M508-9	MVNV-M508-9	M50 x 1.5	48	50	9.0	67.4
	NVNV-M638-14	MVNV-M638-14	M63 x 1.5	48	50	14.0	72.4
NVNV-M638-10	MVNV-M638-10	M63 x 1.5	48	50	10.0	68.4	

Approvals



For applications in railway vehicles and heavy machine construction
High thread and system connection strength

⁴ IP68GT available. Please add
"GT" prior to the thread length
(for example NVNV-M120GT-10)

Connectors NPT, metal thread

Type VNV

Type VNV - Connector straight, metric metal thread

	Order no. IP68, black ⁴	Thread NPT	Fits to conduit size		Thread length (mm)	Overall length (mm)
			NW	Metric		
	NVNV-N022	½"	12	16	15.4	48.1
	NVNV-N027	½"	17	20	15.4	56.4
	NVNV-N043	¾"	23	25	15.7	58.7
	NVNV-N069	1"	29	32	19.6	63.9
	NVNV-N076	1¼"	36	40	20.2	78.6
	NVNV-N088	1½"	48	50	20.6	79.0
	NVNV-N098	2"	48	50	21.4	79.8

Approvals



For applications in railway vehicles and heavy machine construction
High thread and system connection strength

⁴ IP68GT available. Please add
"GT" prior to the thread length
(for example NVNV-N022GT)

Connectors with strain relief, metric, metal thread

Type VNZ

Type VNZ - Connector straight with strain relief, metric metal thread



	Order no. IP68 Compl., black ⑤	Order no. fitting* ⑤	Order no. insert	Thread metric	Fits to conduit size		Terminal range (mm)	Thread length (mm)	Overall length (mm)
					NW	Metric			
	NVNZ-M120S/P1	NVNZ-M120R/P	EK 150p7	M12 x 1.5	10	12	4.0–6.5	5.0	48.5
	NVNZ-M120S/P2		EK 150p8	M12 x 1.5	10	12	5.0–8.0	5.0	48.5
	NVNZ-M120S/P3		EK 150p9	M12 x 1.5	10	12	6.5–9.5	5.0	48.5
	NVNZ-M160S/P1	NVNZ-M160R/P	E 150p7	M16 x 1.5	10	12	4.0–6.5	6.0	49.5
	NVNZ-M160S/P2		E 150p8	M16 x 1.5	10	12	5.0–8.0	6.0	49.5
	NVNZ-M160S/P3		E 150p9	M16 x 1.5	10	12	6.5–9.5	6.0	49.5
	NVNZ-M202S/P1	NVNZ-M202R/P	E 152p7	M20 x 1.5	12	16	4.0–6.5	6.0	54.0
	NVNZ-M202S/P3		E 152p9	M20 x 1.5	12	16	6.5–9.5	6.0	54.0
	NVNZ-M202S/P4		E 152p11	M20 x 1.5	12	16	7.0–10.5	6.0	54.0
	NVNZ-M207S/P3	NVNZ-M207R/P	E 152p9	M20 x 1.5	17	20	6.5–9.5	6.5	60.0
	NVNZ-M207S/P4		E 152p11	M20 x 1.5	17	20	7.0–10.5	6.5	60.0
	NVNZ-M207S/P5		E 152p13	M20 x 1.5	17	20	9.0–13.0	6.5	60.0
	NVNZ-M253S/P5	NVNZ-M253R/P	EK 154p13	M25 x 1.5	23	25	9.0–13.0	7.5	72.5
	NVNZ-M253S/P6		EK 154p16	M25 x 1.5	23	25	11.5–15.5	7.5	72.5
	NVNZ-M257S/P4	NVNZ-M257R/P	E 153p11	M25 x 1.5	17	20	7.0–10.5	7.5	61.5
	NVNZ-M257S/P5		E 153p13	M25 x 1.5	17	20	9.0–13.0	7.5	61.5
	NVNZ-M257S/P6		E 153p16	M25 x 1.5	17	20	11.5–15.5	7.5	61.5
	NVNZ-M323S/P4	NVNZ-M323R/P	E 154p18	M32 x 1.5	23	25	14.0–18.0	8.0	73.0
	NVNZ-M323S/P5	NVNZ-M323R1/P	E 154p20	M32 x 1.5	23	25	17.0–20.5	8.0	73.0
	NVNZ-M329S/P2	NVNZ-M329R/P	EK 155p18	M32 x 1.5	29	32	14.0–18.0	8.0	73.0
	NVNZ-M329S/P3		EK 155p20	M32 x 1.5	29	32	17.0–20.5	8.0	73.0
	NVNZ-M329S/P4		EK 155p25	M32 x 1.5	29	32	20.0–25.0	8.0	73.0
	NVNZ-M406S/P1	NVNZ-M406R/P	E 156p25HF	M40 x 1.5	36	40	20.0–25.0	9.0	87.0
	NVNZ-M406S/P2		EK 156p28	M40 x 1.5	36	40	24.0–28.0	9.0	87.0
	NVNZ-M409S/P1	NVNZ-M409R/P	E 155p16	M40 x 1.5	29	32	11.5–15.5	8.0	73.0
	NVNZ-M409S/P2		E 155p18	M40 x 1.5	29	32	14.0–18.0	8.0	73.0
	NVNZ-M409S/P3		E 155p20	M40 x 1.5	29	32	17.0–20.5	8.0	73.0
	NVNZ-M409S/P4		E 155p25	M40 x 1.5	29	32	20.0–25.0	8.0	73.0
	NVNZ-M409S/P5		E 155p28	M40 x 1.5	29	32	24.0–28.0	8.0	73.0
	NVNZ-M506S/P1	NVNZ-M506R/P	E 156p32	M50 x 1.5	36	40	27.0–32.0	9.0	89.5
NVNZ-M506S/P3		E 156p36	M50 x 1.5	36	40	32.0–36.0	9.0	89.5	
NVNZ-M508S/P2	NVNZ-M508R/P	E 157p36HF	M50 x 1.5	48	50	32.0–36.0	9.0	92.0	
NVNZ-M508S/P3		E 157p40HF	M50 x 1.5	48	50	36.0–40.0	9.0	92.0	
NVNZ-M638S/P1	NVNZ-M638R/P	E 158pm1x35	M63 x 1.5	48	50	32.0–35.0	10.0	90.5	
NVNZ-M638S/P2		E 158p44	M63 x 1.5	48	50	39.0–44.0	10.0	90.5	

*without insert

For applications in railway vehicles and heavy machine construction

For the separation of damp and dry areas

Sealing inserts are made from TPE-V

With integrated strain relief and optimal ingress protection at the cable (up to IP68/10 bar)

High thread and system connection strength

Temperature range sealing insert Pflitsch: -40°C to +135°C

Note: For several conductors multiple sealing inserts MDE are available. R/P version of fitting has to be used in combination with multiple sealing inserts

⑤ IP68GT available. Please replace "S" or "R" with "GT" (e.g. NVNZ-M120GT/P1, NVNZ-M120GT/P)

Fire barrier connectors with strain relief, metric, metal thread

Type VNZ

Type VNZ - Fire barrier connector straight with strain relief, metric metal thread



	Order no. IP68 Compl., black ⑤	Thread metric	Fits to conduit size		Terminal range (mm)	Thread length (mm)	Overall length (mm)
			NW	Metric			
	NVNZ-M120S/B1	M12 x 1.5	10	12	4.0–6.5	5.0	48.5
	NVNZ-M120S/B2	M12 x 1.5	10	12	5.0–8.0	5.0	48.5
	NVNZ-M120S/B3	M12 x 1.5	10	12	6.5–9.5	5.0	48.5
	NVNZ-M160S/B1	M16 x 1.5	10	12	4.0–6.5	6.0	49.5
	NVNZ-M160S/B2	M16 x 1.5	10	12	5.0–8.0	6.0	49.5
	NVNZ-M160S/B3	M16 x 1.5	10	12	6.5–9.5	6.0	49.5
	NVNZ-M202S/B1	M20 x 1.5	12	16	4.0–6.5	6.0	54.0
	NVNZ-M202S/B3	M20 x 1.5	12	16	6.5–9.5	6.0	54.0
	NVNZ-M202S/B4	M20 x 1.5	12	16	7.0–10.5	6.0	54.0
	NVNZ-M207S/B1	M20 x 1.5	17	20	4.0–6.5	6.5	60.0
	NVNZ-M207S/B2	M20 x 1.5	17	20	5.0–8.0	6.5	60.0
	NVNZ-M207S/B3	M20 x 1.5	17	20	6.5–9.5	6.5	60.0
	NVNZ-M207S/B4	M20 x 1.5	17	20	7.0–10.5	6.5	60.0
	NVNZ-M207S/B5	M20 x 1.5	17	20	9.0–13.0	6.5	60.0
	NVNZ-M253S/B5	M25 x 1.5	23	25	9.0–13.0	7.5	72.5
	NVNZ-M253S/B6	M25 x 1.5	23	25	11.5–15.5	7.5	72.5
	NVNZ-M257S/B4	M25 x 1.5	17	20	7.0–10.0	7.5	61.5
	NVNZ-M257S/B5	M25 x 1.5	17	20	9.0–13.0	7.5	61.5
	NVNZ-M257S/B6	M25 x 1.5	17	20	11.5–15.5	7.5	61.5
	NVNZ-M323S/B4	M32 x 1.5	23	25	14.0–18.0	8.0	73.0
	NVNZ-M323S/B5	M32 x 1.5	23	25	17.0–20.5	8.0	73.0
	NVNZ-M329S/B2	M32 x 1.5	29	32	14.0–18.0	8.0	73.0
	NVNZ-M329S/B3	M32 x 1.5	29	32	17.0–20.5	8.0	73.0
	NVNZ-M329S/B4	M32 x 1.5	29	32	20.0–25.0	8.0	73.0
	NVNZ-M406S/B1	M40 x 1.5	36	40	20.0–25.0	9.0	87.0
	NVNZ-M406S/B2	M40 x 1.5	36	40	24.0–28.0	9.0	87.0
	NVNZ-M409S/B1	M40 x 1.5	29	32	11.5–15.5	8.0	73.0
	NVNZ-M409S/B2	M40 x 1.5	29	32	14.0–18.0	8.0	73.0
	NVNZ-M409S/B3	M40 x 1.5	29	32	17.0–20.5	8.0	73.0
	NVNZ-M409S/B4	M40 x 1.5	29	32	20.0–25.0	8.0	73.0
	NVNZ-M409S/B5	M40 x 1.5	29	32	24.0–28.0	8.0	73.0
	NVNZ-M506S/B1	M50 x 1.5	36	40	27.0–32.0	9.0	89.5
	NVNZ-M506S/B3	M50 x 1.5	36	40	32.0–36.0	9.0	89.5
NVNZ-M508S/B2	M50 x 1.5	48	50	32.0–36.0	9.0	92.0	
NVNZ-M508S/B3	M50 x 1.5	48	50	36.0–40.0	9.0	92.0	
NVNZ-M638S/B1	M63 x 1.5	48	50	32.0–35.0	10.0	90.5	
NVNZ-M638S/B2	M63 x 1.5	48	50	39.0–44.0	10.0	90.5	

*without insert

Fire barrier function, according to standard EN45545-2/-3

For applications in railway vehicles and heavy machine construction

For the separation of damp and dry areas

Sealing inserts are made from T805

With integrated strain relief and optimal ingress protection at the cable (up to IP68/10 bar)

High thread and system connection strength

Temperature range sealing insert Pflitsch: –40°C to +135°C

Note: For several conductors multiple sealing inserts MDE are available.

R/P version of fitting has to be used in combination with multiple sealing inserts

⑤ IP68GT available. Please replace “S” or “R” with “GT” (e.g. NVNZ-M120GT/P1, NVNZ-M120GT/P)

Connectors with strain relief, metric, long metal thread

Type VNZ

Type VNZ - Connector straight with strain relief, metric long metal thread



	Order no. IP68 Compl., black ⑤	Order no. fitting* ⑤	Order no. insert	Thread metric	Fits to conduit size		Terminal range (mm)	Thread length (mm)	Overall length (mm)
					NW	Metric			
	NVNZ-M120S/P1-L	NVNZ-M120R/P-L	EK 150p7	M12 x 1.5	10	12	4.0–6.5	15.0	66.5
	NVNZ-M120S/P3-L			M12 x 1.5	10	12	6.5–9.5	15.0	66.5
	NVNZ-M160S/P1-L	NVNZ-M160R/P-L	E 150p7	M16 x 1.5	10	12	4.0–6.5	15.0	58.5
	NVNZ-M160S/P2-L		E 150p8	M16 x 1.5	10	12	5.0–8.0	15.0	58.5
	NVNZ-M160S/P3-L		E 150p9	M16 x 1.5	10	12	6.5–9.5	15.0	58.5
	NVNZ-M202S/P1-L	NVNZ-M202R/P-L	E 152p7	M20 x 1.5	12	16	4.0–6.5	15.0	62.5
	NVNZ-M202S/P3-L		E 152p9	M20 x 1.5	12	16	6.5–9.5	15.0	62.5
	NVNZ-M202S/P4-L		E 152p11	M20 x 1.5	12	16	7.0–10.5	15.0	62.5
	NVNZ-M207S/P3-L	NVNZ-M207R/P-L	E 152p9	M20 x 1.5	17	20	6.5–9.5	15.0	68.5
	NVNZ-M207S/P4-L		E 152p11	M20 x 1.5	17	20	7.0–10.5	15.0	68.5
	NVNZ-M207S/P5-L		E 152p13	M20 x 1.5	17	20	9.0–13.0	15.0	68.5
	NVNZ-M257S/P5-L	NVNZ-M257R/P-L	E 153p13	M25 x 1.5	17	20	9.0–13.0	15.0	69.0
	NVNZ-M257S/P6-L		E 153p16	M25 x 1.5	17	20	11.5–15.5	15.0	69.0
	NVNZ-M323S/P4-L	NVNZ-M323R/P-L	E 154p18	M32 x 1.5	23	25	14.0–18.0	15.0	80.0
	NVNZ-M323S/P5-L	NVNZ-M323R1/P-L	E 154p20	M32 x 1.5	23	25	17.0–20.5	15.0	80.0
	NVNZ-M329S/P2-L	NVNZ-M329R/P-L	E 155p18	M32 x 1.5	29	32	14.0–18.0	15.0	91.0
	NVNZ-M329S/P3-L		E 155p20	M32 x 1.5	29	32	17.0–20.5	15.0	91.0
	NVNZ-M409S/P3-L	NVNZ-M409R/P-L	E 155p20	M40 x 1.5	29	32	17.0–20.5	15.0	80.0
	NVNZ-M409S/P4-L		E 155p25	M40 x 1.5	29	32	20.0–25.0	15.0	80.0
	NVNZ-M409S/P5-L		E 155p28	M40 x 1.5	29	32	24.0–28.0	15.0	80.0
	NVNZ-M506S/P1-L	NVNZ-M506R/P-L	E 156p32	M50 x 1.5	36	40	27.0–32.0	15.0	94.5
	NVNZ-M506S/P3-L		E 15p36	M50 x 1.5	36	40	32.0–36.0	15.0	94.5
	NVNZ-M508S/P2-L	NVNZ-M508R/P-L	E 157p36HF	M50 x 1.5	48	50	32.0–36.0	15.0	97.0
	NVNZ-M508S/P3-L		E 157p40HF	M50 x 1.5	48	50	36.0–40.0	15.0	97.0
	NVNZ-M638S/P1-L	NVNZ-M638R/P-L	E 158pm1X35	M63 x 1.5	48	50	32.0–35.0	15.0	95.5
	NVNZ-M638S/P2-L		E 158p44	M63 x 1.5	48	50	39.0–44.0	15.0	95.5

*without insert

For applications in railway vehicles and heavy machine construction

For the separation of damp and dry areas

Sealing inserts are made from TPE-V

With integrated strain relief and optimal ingress protection at the cable (up to IP68/10 bar)

High thread and system connection strength

Temperature range sealing insert Pflitsch: –40°C to +135°C

Note: For several conductors multiple sealing inserts MDE are available

R/P version of fitting has to be used in combination with multiple sealing inserts

⑤ IP68GT available. Please
replace “S” or “R” with “GT”
(e.g. NVNZ-M120GT/P1-L)

Connectors metric, metal thread

Type VAV

Type VAV - Connector 45° elbow, metric metal thread

	Order no. IP68, black ⁴	Order no. IP68, grey ⁴	Thread metric	Fits to conduit size		Thread length (mm)	External dimensions (mm)
				NW	Metric		
	NVAV-M120-10	MVAV-M120-10	M12 x 1.5	10	12	10.0	48.5 x 37.0
	NVAV-M120-5	MVAV-M120-5	M12 x 1.5	10	12	5.0	43.5 x 37.0
	NVAV-M162-10	MVAV-M162-10	M16 x 1.5	12	16	10.0	53.0 x 40.5
	NVAV-M162-5	MVAV-M162-5	M16 x 1.5	12	16	5.0	48.0 x 40.5
	NVAV-M207-10	MVAV-M207-10	M20 x 1.5	17	20	10.0	60.5 x 51.5
	NVAV-M207-6	MVAV-M207-6	M20 x 1.5	17	20	6.0	56.5 x 51.5
	NVAV-M253-11	MVAV-M253-11	M25 x 1.5	23	25	11.0	70.0 x 60.5
	NVAV-M253-7	MVAV-M253-7	M25 x 1.5	23	25	7.0	66.0 x 60.5
	NVAV-M257-11	MVAV-M257-11	M25 x 1.5	17	20	11.0	61.5 x 54.5
	NVAV-M323-13	MVAV-M323-13	M32 x 1.5	23	25	13.0	72.0 x 64.5
	NVAV-M329-13	MVAV-M329-13	M32 x 1.5	29	32	13.0	77.0 x 68.0
	NVAV-M329-8	MVAV-M329-8	M32 x 1.5	29	32	8.0	72.0 x 68.0
	NVAV-M406-13	MVAV-M406-13	M40 x 1.5	36	40	13.0	94.0 x 87.5
	NVAV-M406-8	MVAV-M406-8	M40 x 1.5	36	40	8.0	89.0 x 87.5
	NVAV-M409-13	MVAV-M409-13	M40 x 1.5	29	32	13.0	77.0 x 73.0
	NVAV-M506-14	MVAV-M506-14	M50 x 1.5	36	40	14.0	95.0 x 92.5
	NVAV-M508-14	MVAV-M508-14	M50 x 1.5	48	50	14.0	102.0 x 101.0
	NVAV-M508-9	MVAV-M508-9	M50 x 1.5	48	50	9.0	97.0 x 101.0
NVAV-M638-14	MVAV-M638-14	M63 x 1.5	48	50	14.0	102.0 x 104.0	
NVAV-M638-10	MVAV-M638-10	M63 x 1.5	48	50	10.0	98.0 x 104.0	

Approvals



For applications in railway vehicles and heavy machine construction
High thread and system connection strength

⁴ IP68GT available. Please add "GT" prior to the thread length (e.g. NVAV-M120GT-10, NVBV-M120GT-10)

Connectors metric, metal thread

Type VBV

Type VBV - Connector 90° curved elbow, metric metal thread

	Order no. IP68, black ^⑤	Order no. IP68, grey ^⑤	Thread metric	Fits to conduit size		Thread length (mm)	External dimensions (mm)
				NW	Metric		
	NVBV-M207-10	MVBV-M207-10	M20 x 1.5	17	20	10.0	51.0 x 73.0
	NVBV-M207-6	MVBV-M207-6	M20 x 1.5	17	20	6.0	47.0 x 73.0
	NVBV-M257-11	MVBV-M257-11	M25 x 1.5	17	20	11.0	52.0 x 76.0
	NVBV-M257-7	MVBV-M257-7	M25 x 1.5	17	20	7.0	48.0 x 76.0
	NVBV-M253-11	MVBV-M253-11	M25 x 1.5	23	25	11.0	62.5 x 85.0
	NVBV-M253-7	MVBV-M253-7	M25 x 1.5	23	25	7.0	58.5 x 85.0
	NVBV-M323-13	MVBV-M323-13	M32 x 1.5	23	25	13.0	64.5 x 89.0
	NVBV-M323-8	MVBV-M323-8	M32 x 1.5	23	25	8.0	59.5 x 89.0
	NVBV-M329-13	MVBV-M329-13	M32 x 1.5	29	32	13.0	74.0 x 94.5
	NVBV-M329-8	MVBV-M329-8	M32 x 1.5	29	32	8.0	69.0 x 94.5
	NVBV-M409-13	MVBV-M409-13	M40 x 1.5	29	32	13.0	75.5 x 100.5
	NVBV-M409-8	MVBV-M409-8	M40 x 1.5	29	32	8.0	70.5 x 100.5
	NVBV-M406-13	MVBV-M406-13	M40 x 1.5	36	40	13.0	86.5 x 123.0
	NVBV-M406-8	MVBV-M406-8	M40 x 1.5	36	40	8.0	81.5 x 123.0
	NVBV-M506-14	MVBV-M506-14	M50 x 1.5	36	40	14.0	87.5 x 130.0
	NVBV-M506-9	MVBV-M506-9	M50 x 1.5	36	40	9.0	82.5 x 130.0
	NVBV-M508-14	MVBV-M508-14	M50 x 1.5	48	50	14.0	100.5 x 135.0
NVBV-M508-9	MVBV-M508-9	M50 x 1.5	48	50	9.0	95.5 x 135.0	
NVBV-M638-10	MVBV-M638-10	M63 x 1.5	48	50	14.0	100.5 x 138.0	
NVBV-M638-14	MVBV-M638-14	M63 x 1.5	48	50	10.0	96.5 x 138.0	

Approvals



For applications in railway vehicles and heavy machine construction

High thread and system connection strength

Smooth elbow allows easy threading of wires and cables



Note: Appropriate standard elbows of type VW are available for smaller conduit sizes NW 10 to NW 12

^⑤ IP68GT available. Please add "GT" prior to the thread length (e.g. NVAV-M120GT-10, NVBV-M120GT-10)

Connectors metric, metal thread

Type VWV

Type VWV - Connector 90° elbow, metric metal thread

	Order no. IP68, black ④	Order no. IP68, grey ④	Thread metric	Fits to conduit size		Thread length (mm)	External dimensions (mm)
				NW	Metric		
	NVWV-M120-10	MVWV-M120-10	M12 x 1.5	10	12	10.0	37.5 x 39.5
	NVWV-M120-5	MVWV-M120-5	M12 x 1.5	10	12	5.0	32.5 x 39.5
	NVWV-M160-10	MVWV-M160-10	M16 x 1.5	10	12	10.0	37.5 x 41.5
	NVWV-M160-5	MVWV-M160-5	M16 x 1.5	10	12	5.0	32.5 x 41.5
	NVWV-M162-10	MVWV-M162-10	M16 x 1.5	12	16	10.0	42.0 x 46.5
	NVWV-M162-5	MVWV-M162-5	M16 x 1.5	12	16	5.0	37.0 x 46.5
	NVWV-M202-10	MVWV-M202-10	M20 x 1.5	12	16	10.0	42.0 x 49.0
	NVWV-M202-6	MVWV-M202-6	M20 x 1.5	12	16	6.0	38.0 x 49.0
	NVWV-M207-10	MVWV-M207-10	M20 x 1.5	17	20	10.0	47.0 x 58.5
	NVWV-M207-6	MVWV-M207-6	M20 x 1.5	17	20	6.0	43.0 x 58.5
	NVWV-M253-11	MVWV-M253-11	M25 x 1.5	23	25	11.0	59.0 x 67.0
	NVWV-M253-7	MVWV-M253-7	M25 x 1.5	23	25	7.0	55.0 x 67.0
	NVWV-M329-13	MVWV-M329-13	M32 x 1.5	29	32	13.0	68.0 x 74.5
	NVWV-M329-8	MVWV-M329-8	M32 x 1.5	29	32	8.0	63.0 x 74.5
	NVWV-M406-13	MVWV-M406-13	M40 x 1.5	36	40	13.0	80.5 x 98.0
	NVWV-M406-8	MVWV-M406-8	M40 x 1.5	36	40	8.0	75.5 x 98.0
	Approvals	NVWV-M508-14	MVWV-M508-14	M50 x 1.5	48	50	14.0
	NVWV-M508-9	MVWV-M508-9	M50 x 1.5	48	50	9.0	90.5 x 111.0
	NVWV-M638-14	MVWV-M638-14	M63 x 1.5	48	50	14.0	94.5 x 114.0
	NVWV-M638-10	MVWV-M638-10	M63 x 1.5	48	50	10.0	90.5 x 114.0

For applications in railway vehicles and heavy machine construction
High thread and system connection strength

Note: Curved elbows of type VB are also available for sizes NW 17 to NW 48

④ IP68GT available. Please add
"GT" prior to the thread length
(e.g. NVWV-M120GT-10)

Connectors with strain relief, metric, metal thread

Type VWZ

Type VWZ - Connector 90° elbow with strain relief, metric metal thread



	Order no. IP68 Compl., black ⑤	Order no. fitting* ⑤	Order no. insert	Thread metric	Fits to conduit size		Terminal range (mm)	Thread length (mm)	Overall length (mm)
					NW	Metric			
	NVWZ-M160S/P1	NVWZ-M160R/P	E 150 p7	M16 x 1.5	10	12	4.0–6.5	8.0	65.0
	NVWZ-M160S/P2	–	E 150 p8	M16 x 1.5	10	12	5.0–8.0	8.0	65.0
	NVWZ-M160S/P3	–	E 150 p9	M16 x 1.5	10	12	6.5–9.5	8.0	65.0
	NVWZ-M202S/P1	NVWZ-M202R/P	E 127 p7	M20 x 1.5	12	16	4.0–6.5	8.0	74.5
	NVWZ-M202S/P3	–	E 152 p9	M20 x 1.5	12	16	6.5–9.5	8.0	74.5
	NVWZ-M202S/P4	–	E 152 p11	M20 x 1.5	12	16	7.0–10.5	8.0	74.5
	NVWZ-M207S/P1	NVWZ-M207R/P	E 152 p7	M20 x 1.5	17	20	4.0–6.5	8.0	81.0
	NVWZ-M207S/P3	–	E 152 p9	M20 x 1.5	17	20	6.5–9.5	8.0	81.0
	NVWZ-M207S/P4	–	E 152 p11	M20 x 1.5	17	20	7.0–10.5	8.0	81.0
	NVWZ-M207S/P5	–	E 152 p13	M20 x 1.5	17	20	9.0–13.0	8.0	81.0
	NVWZ-M257S/P5	NVWZ-M257R/P	E 153 p13	M25 x 1.5	17	20	9.0–13.0	8.0	84.0
	NVWZ-M257S/P6	–	E 153 p16	M25 x 1.5	17	20	11.5–15.5	8.0	84.0

*without insert

For applications in railway vehicles and heavy machine construction

For the separation of damp and dry areas

Straight connector: Specially formulated polyamide 6

90° elbow: Zinc diecast

Female thread and locknut: Nickel-plated brass

Pflitsch sealing insert: TPE-V

With integrated strain relief and optimal ingress protection at the cable (up to IP68/10 bar)

High thread and system connection strength

Temperature range sealing insert Pflitsch: –40°C to +135°C

⑤ IP68GT available. Please replace “S” or “R” with “GT” (e.g. NVWZ-M160GT/P1)

Connectors PG, polyamide thread

Type VN

Type VN - Connector straight, PG thread

	Order no. IP66 ①	Order no. IP68 ① ②	Thread PG	Fits to conduit size		Thread length (mm)	External dimensions (mm)
				NW	Metric		
	BVND-P07MGT-11	BVNV-P07M	07	07	10	11.0	34.5
	BVND-P07MGT-8	–	07	07	10	8.0	31.5
	BVND-P070GT-11	BVNV-P070	07	10	12	11.0	36.5
	BVND-P070GT-8	–	07	10	12	8.0	33.5
	BVND-P072GT-11	BVNV-P072	07	12	16	11.0	39.0
	BVND-P072GT-8	–	07	12	16	8.0	36.0
	BVND-P09MGT-11	BVNV-P09M	09	07	10	11.0	34.5
	BVND-P09MGT-8	–	09	07	10	8.0	31.5
	BVND-P090GT-11	BVNV-P090	09	10	12	11.0	36.5
	BVND-P090GT-8	–	09	10	12	8.0	33.5
	BVND-P092GT-11	BVNV-P092	09	12	16	11.0	39.0
	BVND-P092GT-8	–	09	12	16	8.0	36.0
	BVND-P097GT-11	BVNV-P097	09	17	20	11.0	47.5
	BVND-P097GT-8	–	09	17	20	8.0	44.5
	BVND-P11MGT-11	BVNV-P11M	11	07	10	11.0	34.5
	BVND-P11MGT-8	–	11	07	10	8.0	31.5
	BVND-P110GT-11	BVNV-P110	11	10	12	11.0	36.5
	BVND-P110GT-8	–	11	10	12	8.0	33.5
	BVND-P112GT-11	BVNV-P112	11	12	16	11.0	39.0
	BVND-P112GT-8	–	11	12	16	8.0	36.0
	BVND-P117GT-11	BVNV-P117	11	17	20	11.0	47.5
	BVND-P117GT-8	–	11	17	20	8.0	44.5
	BVND-P13MGT-11	BVNV-P13M	13.5	07	10	11.0	34.5
	BVND-P13MGT-8	–	13.5	07	10	8.0	31.5
	BVND-P130GT-11	BVNV-P130	13.5	10	12	11.0	36.5
	BVND-P130GT-8	–	13.5	10	12	8.0	33.5
	BVND-P132GT-11	BVNV-P132	13.5	12	16	11.0	39.0
	BVND-P132GT-8	–	13.5	12	16	8.0	36.0
	BVND-P137GT-11	BVNV-P137	13.5	17	20	11.0	47.5
	BVND-P137GT-8	–	13.5	17	20	8.0	44.5
	BVND-P160GT-11	–	16	10	12	11.0	36.5
	BVND-P160GT-8	–	16	10	12	8.0	33.5
	BVND-P162GT-11	BVNV-P162	16	12	16	11.0	39.0
	BVND-P163GT-11	BVNV-P163	16	23	25	11.0	51.0
	BVND-P163GT-8	–	16	23	25	8.0	48.0
	BVND-P167GT-11	BVNV-P167	16	17	20	11.0	47.5
	BVND-P167GT-8	–	16	17	20	8.0	44.5
	BVND-P213GT	BVNV-P213	21	23	25	12.0	52.0
	BVND-P296GT	BVNV-P296	29	36	40	12.0	67.5
	BVND-P299GT	BVNV-P299	29	29	32	12.0	53.0
	BVND-P366GT	BVNV-P366	36	36	40	13.0	66.0
	BVND-P368GT	BVNV-P368	36	48	50	13.0	68.5
	BVND-P428GT	BVNV-P428	42	48	50	13.0	68.5
	BVND-P488GT	BVNV-P488	48	48	50	13.0	66.5

c
RA
US

Approvals



① Please replace “B” for black with “S” for grey in front of the order no.

② IP68GT available. Please add “GT” after the order no.

For cable protection systems in a wide range of applications

Connectors PG, polyamide thread

Type VNDZ/VNZ & VA

Type VNDZ/VNZ - Connector straight with strain relief, PG thread

	Order no. IP66 ①	Order no. IP68 ① ③	Thread PG	Fits to conduit size		Terminal range	Thread length (mm)	Overall length (mm)
				NW	Metric			
	BVNDZ-P090GT	BVNZ-P090S	09	10	12	4.0–8.0	7.5	56.0
	BVNDZ-P112GT	BVNZ-P112S	11	12	16	5.0–10.0	8.0	60.5
	BVNDZ-P132GT	BVNZ-P132S	13.5	12	16	6.0–12.0	9.0	62.0
	BVNDZ-P137GT	BVNZ-P137S	13.5	17	20	6.0–12.0	9.0	69.0
	BVNDZ-P167GT	BVNZ-P167S	16	17	20	10.0–14.0	10.0	72.0
	BVNDZ-P163GT	BVNZ-P163S	16	23	25	10.0–14.0	10.0	79.0
	BVNDZ-P213GT	BVNZ-P213S	21	23	25	13.0–18.0	11.0	82.0
	BVNDZ-P299GT	BVNZ-P299S	29	29	32	18.0–25.0	11.0	85.0
	BVNDZ-P366GT	BVNZ-P366S	36	36	40	22.0–32.0	13.0	112.0
	BVNDZ-P488GT	BVNZ-P488S	48	48	50	34.0–44.0	14.0	112.0

For machine and plant construction

For separation of damp and dry areas

Integrated strain relief optimally holds and seals cables

If several conductors are used with the connector multiple sealing inserts should be considered

Note: For several conductors multiple sealing inserts MDE are available

Type VA - Connector 45° elbow, PG thread

	Order no. IP66 ①	Order no. IP68 ① ②	Thread PG	Fits to conduit size		Thread length (mm)	Overall length (mm)
				NW	Metric		
	BVAD-P090GT	BVAV-P090	09	10	12	11.0	43.5 x 37.0
	BVAD-P112GT	BVAV-P112	11	12	16	11.0	48.0 x 40.0
	BVAD-P132GT	BVAV-P132	13.5	12	16	11.0	48.0 x 41.5
	BVAD-P137GT	BVAV-P137	13.5	17	20	11.0	55.5 x 51.5
	BVAD-P167GT	BVAV-P167	16	17	20	11.0	55.5 x 51.5
	BVAD-P213GT	BVAV-P213	21	23	25	11.0	63.0 x 58.0
	BVAD-P299GT	BVAV-P299	29	29	32	12.0	69.0 x 66.0
	BVAD-P366GT	BVAV-P366	36	36	40	13.0	86.0 x 86.0
	BVAD-P488GT	BVAV-P488	48	48	50	13.0	94.0 x 100.0

Approvals



For cable protection systems in a wide range of applications

- ① Please replace "B" for black with "S" for grey in front of the order no.
- ② IP68GT available. Please add "GT" after the order no.
- ③ IP68GT available. Please replace "S" at the end with "GT" (e.g. BVNZ-P167GT).

Connectors PG, polyamide thread

Type VB

Type VB - Connector 90° curved elbow, PG thread

	Order no. IP68 ①	Order no. IP68 ① ②	Thread PG	Fits to conduit size		Thread length (mm)	External dimensions (mm)
				NW	Metric		
	BVBD-P167GT	BVBV-P167	16	17	20	11.0	47.5 x 73.0
	BVBD-P213GT	BVBV-P213	21	23	25	12.0	57.5 x 85.0
	BVBD-P299GT	BVBV-P299	29	29	32	12.0	67.5 x 96.0
	BVBD-P366GT	BVBV-P366	36	36	40	13.0	79.0 x 123.0
	BVBD-P488GT	BVBV-P488	48	48	50	13.0	92.5 x 135.0

Approvals



For cable protection systems in a wide range of applications
 Smooth elbow allows easy threading of wires and cables
Note: For smaller conduit sizes NW 07 to NW 12 appropriate standard elbows of type VW are also available

- ① Please replace "B" for black with "S" for grey in front of the order no.
- ② IP68GT available. Please add "GT" after the order no.

Connectors PG, polyamide thread

Type VW

Type VW - Connector 90° elbow, PG thread

	Order no.	Order no.	Thread	Fits to conduit size		Thread length (mm)	External dimensions (mm)
	IP66 ①	IP68 ① ②		NW	Metric		
	BVWD-P07MGT-11	BVWV-P07M	07	07	10	11.0	32.0 x 35.0
	BVWD-P07MGT-8	-	07	07	10	8.0	29.0 x 35.0
	BVWD-P070GT-11	BVWV-P070	07	10	12	11.0	34.0 x 39.5
	BVWD-P070GT-8	-	07	10	12	8.0	31.0 x 39.5
	BVWD-P072GT-11	BVWV-P072	07	12	16	11.0	38.5 x 44.5
	BVWD-P072GT-8	-	07	12	16	8.0	35.5 x 44.5
	BVWD-P09MGT-11	BVWV-P09M	09	07	10	11.0	32.0 x 36.5
	BVWD-P09MGT-8	-	09	07	10	8.0	29.0 x 36.5
	BVWD-P090GT-11	BVWV-P090	09	10	12	11.0	34.0 x 39.5
	BVWD-P090GT-8	-	09	10	12	8.0	31.0 x 39.5
	BVWD-P092GT-11	BVWV-P092	09	12	16	11.0	38.5 x 44.5
	BVWD-P092GT-8	-	09	12	16	8.0	35.5 x 44.5
	BVWD-P11MGT-11	BVWV-P11M	11	07	10	11.0	32.0 x 38.0
	BVWD-P11MGT-8	-	11	07	10	8.0	29.0 x 38.0
	BVWD-P110GT-11	BVWV-P110	11	10	12	11.0	34.0 x 41.0
	BVWD-P110GT-8	-	11	10	12	8.0	31.0 x 41.0
	BVWD-P112GT-11	BVWV-P112	11	12	16	11.0	38.5 x 46.0
	BVWD-P112GT-8	-	11	12	16	8.0	35.5 x 46.0
	BVWD-P13MGT-11	BVWV-P13M	13.5	07	10	11.0	32.0 x 39.5
	BVWD-P13MGT-8	-	13.5	07	10	8.0	29.0 x 39.5
	BVWD-P130GT-11	BVWV-P130	13.5	10	12	11.0	34.0 x 42.5
	BVWD-P130GT-8	-	13.5	10	12	8.0	31.0 x 42.5
	BVWD-P132GT-11	BVWV-P132	13.5	12	16	11.0	38.5 x 47.5
	BVWD-P132GT-8	-	13.5	12	16	8.0	35.5 x 47.5
	BVWD-P137GT-11	BVWV-P137	13.5	17	20	11.0	43.5 x 58.5
	BVWD-P137GT-8	-	13.5	17	20	8.0	40.5 x 58.5
	BVWD-P167GT-11	BVWV-P167	16	17	20	11.0	43.5 x 58.5
	BVWD-P167GT-8	-	16	17	20	8.0	40.5 x 58.5
	BVWD-P213GT	BVWV-P213	21	23	25	12.0	54.0 x 67.0
	BVWD-P299GT	BVWV-P299	29	29	32	12.0	61.5 x 74.5
BVWD-P366GT	BVWV-P366	36	36	40	13.0	72.0 x 98.0	
BVWD-P488GT	BVWV-P488	48	48	50	13.0	85.5 x 111.0	

Approvals



For cable protection systems in a wide range of applications

Note: For sizes NW 17 to NW 48 curved elbows of type VB are also available

- ① Please replace "B" for black with "S" for grey in front of the order no.
- ② IP68GT available. Please add "GT" after the order no.

Connectors PG, metal thread

Type VNV

Type VNV - Connector straight, PG metal thread

	Order no. IP68, black ②	Order no. IP68, grey ②	Thread PG	Fits to conduit size		Thread length (mm)	Overall length (mm)
				NW	Metric		
	NVNV-P090	MVNV-P090	09	10	12	12.0	42.0
	NVNV-P112	MVNV-P112	11	12	16	12.0	45.0
	NVNV-P137	MVNV-P137	13.5	17	20	13.0	54.0
	NVNV-P167	MVNV-P167	16	17	20	13.0	54.0
	NVNV-P213	MVNV-P213	21	23	25	14.0	57.0
	NVNV-P293	MVNV-P293	29	23	25	14.0	57.0
	NVNV-P299	MVNV-P299	29	29	32	14.0	58.5
	NVNV-P366	MVNV-P366	36	36	40	17.0	75.5
	NVNV-P488	MVNV-P488	48	48	50	17.0	75.5

Approvals



For applications in railway vehicles and heavy machine construction
High thread and system connection strength

② IP68GT available. Please add
"GT" after the order no.

Connectors PG, with strain relief, metal thread

Type VNZ

Type VNZ - Connector straight with strain relief, PG metal thread



	Order no. IP68 Compl., black ⑤	Order no. fitting* ⑤	Order no. insert	Thread PG	Fits to conduit size		Terminal range (mm)	Thread length (mm)	Overall length (mm)
					NW	Metric			
	NVNZ-P090S/P1	NVNZ-P090R/P	E 150 p7	09	10	12	4.0–6.5	6.0	49.5
	NVNZ-P090S/P3	–	E 150 p9	09	10	12	6.5–9.5	6.0	49.5
	NVNZ-P110S/P1	NVNZ-P110R/P	E 151 p7	11	10	12	4.0–6.5	6.0	52.0
	NVNZ-P110S/P3	–	E 151 p9	11	10	12	6.5–9.5	6.0	52.0
	NVNZ-P112S/P1	NVNZ-P112R/P	E 151 p7	11	12	16	4.0–6.5	6.0	53.5
	NVNZ-P112S/P3	–	E 151 p9	11	12	16	6.5–9.5	6.0	53.5
	NVNZ-P112S/P4	–	E 151 p11	11	12	16	7.0–10.5	6.0	53.5
	NVNZ-P160S/P1	NVNZ-P160R/P	E 152 p11	16	10	12	4.0–6.5	6.5	52.5
	NVNZ-P167S/P3	NVNZ-P167R/P	E 153 p9	16	17	20	6.5–9.5	6.5	61.0
	NVNZ-P167S/P4	–	E 153 p11	16	17	20	7.0–10.5	6.5	61.0
	NVNZ-P167S/P5	–	E 153 p13	16	17	20	9.0–13.0	6.5	61.0
	NVNZ-P167S/P6	–	E 153 p16	16	17	20	11.5–15.5	6.5	61.0
	NVNZ-P213S/P1	NVNZ-P213R/P	E 154 p11	21	23	25	7.0–10.5	7.0	72.0
	NVNZ-P213S/P4	–	E 154 p18	21	23	25	14.0–18.0	7.0	72.0
	NVNZ-P213S/P5	NVNZ-P213R1/P	E 154 p20	21	23	25	17.0–20.5	7.0	72.0
	NVNZ-P299S/P3	NVNZ-P299R/P	E 155 p20	29	29	32	17.0–20.5	8.0	73.5
	NVNZ-P299S/P4	–	E 155 p25	29	29	32	20.0–25.0	8.0	73.5
	NVNZ-P299S/P5	–	E 155 p28	29	29	32	24.0–28.0	8.0	73.5
	NVNZ-P366S/P1	NVNZ-P366R/P	E 156 p32	36	36	40	27.0–32.0	9.0	88.0
	NVNZ-P366S/P2	–	E 156 p34	36	36	40	29.0–34.0	9.0	88.0
NVNZ-P366S/P3	–	E 156 p36	36	36	40	32.0–36.0	9.0	88.0	
NVNZ-P488S/P1	NVNZ-P488R/P	E 158 pm 1x35	48	48	50	32.0–35.0	10.0	90.5	
NVNZ-P488S/P2	–	E 158 p44	48	48	50	39.0–44.0	10.0	90.5	

*without insert

For applications in railway vehicles and heavy machine construction

For the separation of damp and dry areas

Sealing inserts are made from TPE-V

With integrated strain relief and optimal ingress protection at the cable (up to IP68/10 bar)

High thread and system connection strength

Temperature range sealing insert Pflitsch: –40°C to +135°C

Note: For several conductors multiple sealing inserts MDE are available

R/P version of fitting has to be used in combination with multiple sealing inserts

⑤ IP68GT available. Please replace “S” or “R” with “GT” (e.g. NVNZ-P112GT/P1)

Connectors PG, metal thread

Type VAV & VBV

Type VAV - Connector 45° elbow, PG metal thread

	Order no. IP68, black ②	Order no. IP68, grey ②	Thread PG	Fits to conduit size		Thread length (mm)	External dimensions (mm)
				NW	Metric		
	NVAV-P090	MVAV-P090	09	10	12	12.0	50.5 x 37.0
	NVAV-P112	MVAV-P112	11	12	16	12.0	55.0 x 40.5
	NVAV-P137	MVAV-P137	13.5	17	20	13.0	63.5 x 50.0
	NVAV-P167	MVAV-P167	16	17	20	13.0	63.5 x 50.0
	NVAV-P213	MVAV-P213	21	23	25	14.0	73.0 x 60.5
	NVAV-P299	MVAV-P299	29	29	32	14.0	78.0 x 68.0
	NVAV-P366	MVAV-P366	36	36	40	17.0	98.0 x 87.5
	NVAV-P488	MVAV-P488	48	48	50	17.0	105.0 x 101.0

Approvals



For applications in railway vehicles and heavy machine construction
High thread and system connection strength

Type VBV - Connector 90° curved elbow, PG metal thread

	Order no. IP68, black ②	Order no. IP68, grey ②	Thread PG	Fits to conduit size		Thread length (mm)	External dimensions (mm)
				NW	Metric		
	NVBV-P167	MVBV-P167	16	17	20	13.0	54.0 x 73.0
	NVBV-P213	MVBV-P213	21	23	25	14.0	65.5 x 85.0
	NVBV-P299	MVBV-P299	29	29	32	14.0	75.0 x 96.0
	NVBV-P366	MVBV-P366	36	36	40	17.0	90.5 x 123.0
	NVBV-P488	MVBV-P488	48	48	50	17.0	103.5 x 135.0

Approvals



For applications in railway vehicles and heavy machine construction
High thread and system connection strength
Smooth elbow allows easy threading of wires and cables
Note: For smaller conduit sizes NW 10 to NW 12 appropriate standard elbows of type VW are also available

② IP68GT available. Please add
"GT" after the order no.

Connectors PG, metal thread

Type VWV

Type VWV - Connector 90° elbow, PG metal thread

	Order no. IP68, black ②	Order no. IP68, grey ②	Thread PG	Fits to conduit size		Thread length (mm)	External dimensions (mm)
				NW	Metric		
	NVWV-P090	MVWV-P090	09	10	12	12.0	39.5 x 39.5
	NVWV-P112	MVWV-P112	11	12	16	12.0	45.5 x 45.0
	NVWV-P137	MVWV-P137	13.5	17	20	13.0	50.0 x 58.5
	NVWV-P167	MVWV-P167	16	17	20	13.0	50.0 x 58.5
	NVWV-P213	MVWV-P213	21	23	25	14.0	62.0 x 67.0
	NVWV-P299	MVWV-P299	29	29	32	14.0	69.0 x 74.5
	NVWV-P366	MVWV-P366	36	36	40	17.0	83.5 x 98.0
	NVWV-P488	MVWV-P488	48	48	50	17.0	96.5 x 111.0

Approvals



For applications in railway vehicles and heavy machine construction
 High thread and system connection strength
Note: Curved elbows of type VB are also available for sizes NW 17 to NW 48

② IP68GT available. Please add
 "GT" after the order no.

Connectors GAS, polyamide thread

Type VN & VA

Type VN - Connector straight, GAS thread

	Order no. IP66 ①	Order no. IP68 ① ②	Thread GAS	Fits to conduit size		Thread length (mm)	Overall length (mm)
				NW	Metric		
	BVND-G00MGT	BVNV-G00M	¼"	07	10	11.0	34.5
	BVND-G000GT	BVNV-G000	¼"	10	12	11.0	36.5
	BVND-G010GT	BVNV-G010	⅜"	10	12	11.0	36.5
	BVND-G012GT	BVNV-G012	⅜"	12	16	11.0	39.0
	BVND-G022GT	BVNV-G022	½"	12	16	13.0	41.0
	BVND-G027GT	BVNV-G027	½"	17	20	13.0	49.5
	BVND-G043GT	BVNV-G043	¾"	23	25	14.0	54.0
	BVND-G069GT	BVNV-G069	1"	29	32	15.0	56.0
	BVND-G076GT	BVNV-G076	1¼"	36	40	18.0	71.0
	BVND-G088GT	BVNV-G088	1½"	48	50	18.0	71.5
	BVND-G098GT	BVNV-G098	2"	48	50	18.0	71.5

For cable protection systems in a wide range of applications

Type VA - Connector 45° elbow, GAS thread

	Order no. IP66 ①	Order no. IP68 ① ②	Thread GAS	Fits to conduit size		Thread length (mm)	Overall length (mm)
				NW	Metric		
	BVAD-G000GT	BVAV-G000	¼"	10	12	11.0	43.5 x 37.0
	BVAD-G012GT	BVAV-G012	⅜"	12	16	11.0	48.0 x 40.0
	BVAD-G027GT	BVAV-G027	½"	17	20	13.0	57.5 x 51.5
	BVAD-G043GT	BVAV-G043	¾"	23	25	14.0	67.0 x 60.0
	BVAD-G069GT	BVAV-G069	1"	29	32	15.0	73.5 x 67.0
	BVAD-G076GT	BVAV-G076	1¼"	36	40	18.0	91.5 x 85.5
	BVAD-G088GT	-	1½"	48	50	18.0	99.0 x 96.0
	BVAD-G098GT	BVAV-G098	2"	48	50	18.0	99.0 x 101.0

For cable protection systems in a wide range of applications

① Please replace "B" for black with "S" for grey in front of the order no.

② IP68GT available. Please add "GT" after the order no.

Connectors GAS, polyamide thread

Type VW

Type VW - Connector 90° elbow, GAS thread

	Order no. IP66 ①	Order no. IP68 ① ②	Thread GAS	Fits to conduit size		Thread length (mm)	External dimensions (mm)
				NW	Metric		
	BVWD-G00MGT	BVWV-G00M	¼"	07	10	11.0	32.0 x 36.5
	BVWD-G000GT	BVWV-G000	¼"	10	12	11.0	34.0 x 39.5
	BVWD-G010GT	BVWV-G010	⅜"	10	12	11.0	34.0 x 40.5
	BVWD-G012GT	BVWV-G012	⅜"	12	16	11.0	38.5 x 46.0
	BVWD-G022GT	BVWV-G022	½"	12	16	13.0	40.5 x 47.5
	BVWD-G027GT	BVWV-G027	½"	17	20	13.0	45.5 x 58.5
	BVWD-G043GT	BVWV-G043	¾"	23	25	14.0	56.0 x 66.5
	BVWD-G069GT	BVWV-G069	1"	29	32	15.0	64.5 x 73.5
	BVWD-G076GT	BVWV-G076	1¼"	36	40	18.0	77.0 x 96.0
	BVWD-G088GT	BVWV-G088	1½"	48	50	18.0	90.5 x 106.0
	BVWD-G098GT	BVWV-G098	2"	48	50	18.0	90.5 x 111.0

For cable protection systems in a wide range of applications

- ① Please replace "B" for black with "S" for grey in front of the order no.
- ② IP68GT available. Please add "GT" after the order no.

Connectors NPT, polyamide thread

Type VN & VA

Type VN - Connector straight, NPT thread

	Order no. IP66 ①	Order no. IP68 ① ②	Thread NPT	Fits to conduit size		Thread length (mm)	Overall length (mm)
				NW	Metric		
	BVND-N022GT	BVNV-N022	½"	12	16	13.0	41.5
	BVND-N027GT	BVNV-N027	½"	17	20	13.0	49.5
	BVND-N043GT	BVNV-N043	¾"	23	25	14.0	54.0
	BVND-N069GT	BVNV-N069	1"	29	32	15.0	56.0
	BVND-N076GT	BVNV-N076	1¼"	36	40	18.0	71.0
	BVND-N088GT	BVNV-N088	1½"	48	50	18.0	71.5
	BVND-N098GT	BVNV-N098	2"	48	50	18.0	71.5

Approvals



For cable protection systems in a wide range of applications

Type VA - Connector 45° elbow, NPT thread

	Order no. IP68 ①	Order no. IP68 ① ②	Thread NPT	Fits to conduit size		Thread length (mm)	External dimensions (mm)
				NW	Metric		
	BVAD-N022GT	BVAV-N022	½"	12	16	13.0	50.0 x 41.5
	BVAD-N027GT	BVAV-N027	½"	17	20	13.0	57.5 x 51.5
	BVAD-N043GT	BVAV-N043	¾"	23	25	14.0	67.0 x 60.0
	BVAD-N069GT	BVAV-N069	1"	29	32	15.0	73.5 x 67.0
	BVAD-N076GT	BVAV-N076	1¼"	36	40	18.0	91.5 x 85.5
	BVAD-N088GT	BVAV-N088	1½"	48	50	18.0	99.0 x 96.0
	BVAD-N098GT	BVAV-N098	2"	48	50	18.0	99.0 x 101.0

Approvals



For cable protection systems in a wide range of applications

① Please replace "B" for black with "S" for grey in front of the order no.

② IP68GT available. Please add "GT" after the order no.

Connectors NPT, polyamide thread

Type VW

Type VW - Connector 90° elbow, NPT thread

	Order no. IP68 ①	Order no. IP68 ① ②	Thread NPT	Fits to conduit size		Thread length (mm)	External dimensions (mm)
				NW	Metric		
	BVWD-N022GT	BVWV-N022	½"	12	16	13.0	40.5 x 47.5
	BVWD-N027GT	BVWV-N027	½"	17	20	13.0	45.5 x 58.5
	BVWD-N043GT	BVWV-N043	¾"	23	25	14.0	56.0 x 66.5
	BVWD-N069GT	BVWV-N069	1"	29	32	15.0	64.5 x 73.5
	BVWD-N076GT	BVWV-N076	1¼"	36	40	18.0	77.0 x 96.0
	BVWD-N088GT	BVWV-N088	1½"	48	50	18.0	90.5 x 106.0
	BVWD-N098GT	BVWV-N098	2"	48	50	18.0	90.5 x 111.0

Approvals



For applications in railway vehicles and heavy machine construction
 High thread and system connection strength
Note: Curved elbows of type VB are also available for sizes NW 17 to NW 48

- ① Please replace "B" for black with "S" for grey in front of the order no.
- ② IP68GT available. Please add "GT" after the order no.

Swivel connectors, metric/PG/NPT metal thread

Type SBV & SWV/SBV

Type SBV - Swivel connector 90° curved elbow, metric/PG metal thread

	Order no. IP68, black ⁴	Thread metric	Fits to conduit size		Thread length (mm)	External dimensions (mm)
			NW	Metric		
	NSBV-M207-10	M20 x 1.5	17	20	10.0	62.5 x 74.5
	NSBV-M253-11	M25 x 1.5	23	25	11.0	73.0 x 87.5
	NSBV-M329-13	M32 x 1.5	29	32	13.0	86.5 x 98.0
	NSBV-M406-13	M40 x 1.5	36	40	13.0	98.5 x 127.5
	NSBV-M409-13	M40 x 1.5	29	32	13.0	86.5 x 98.0
	NSBV-M508-14	M50 x 1.5	48	50	14.0	113.5 x 139.0
	NSBV-M638-14	M63 x 1.5	48	50	14.0	110.0 x 139.0

	Order no. IP68, black ⁴	Thread PG	Fits to conduit size		Thread length (mm)	External dimensions (mm)
			NW	Metric		
Approvals 	NSBV-P167-6.5	16	17	20	6.5	58.0 x 74.5
	NSBV-P213-7	21	23	25	7.0	69.0 x 87.5
	NSBV-P299-8	29	29	32	8.0	80.0 x 98.0
	NSBV-P366-9	36	36	40	9.0	91.5 x 127.5
	NSBV-P488-10	48	48	50	10.0	106.0 x 139.0

For applications with high technical requirements mainly in machine building
 Suitable for occasional rotation
 Thread and integrated swivel adapter made from nickel-plated brass
 High thread and system connection strength
 Smooth elbow allows easy threading of wires and cables

Type SWV/SBV - Swivel connector 90° curved elbow, NPT metal thread

	Order no. IP68, black ⁴	Thread NPT	Fits to conduit size		Thread length (mm)	External dimensions (mm)
			NW	Metric		
	NSWV-N022/01	½"	12	16	15.4	57.0 x 48.5
	NSBV-N027/01	½"	17	20	15.4	66.5 x 74.5
	NSBV-N043/01	¾"	23	25	15.7	77.5 x 87.5
	NSBV-N069/01	1"	29	32	19.6	92.0 x 98.0
	NSBV-N076/01	1¼"	36	40	20.2	104.5 x 125.5
	NSBV-N088/01	1½"	48	50	20.6	118.5 x 138.5
	NSBV-N098/01	2"	48	50	21.4	119.5 x 138.5

Approvals



For applications with high technical requirements mainly in heavy machine building and rail applications
 Suitable for occasional rotation
 Thread and integrated swivel adapter made from colourless anodized aluminium
 High thread and system connection strength
 Smooth elbow allows easy threading of wires and cables

⁴ IP68GT available. Please add
 "GT" prior to the thread length
 (for example NSBV-M329GT-13)

Swivel connectors, metric, NPT metal thread

Type SNV

Type SNV - Swivel connector, straight, IP68 metric metal thread

	Order no. IP68, black ^④	Thread metric	Fits to conduit size		Thread length (mm)	Overall length (mm)
			NW	Metric		
	NSNV-M120-10	M12 x 1.5	10	12	10.0	50.5
	NSNV-M162-10	M16 x 1.5	12	16	10.0	53.5
	NSNV-M207-10	M20 x 1.5	17	20	10.0	62.5
	NSNV-M253-11	M25 x 1.5	23	25	11.0	67.5
	NSNV-M329-13	M32 x 1.5	29	32	13.0	72.0
	NSNV-M329-7	M32 x 1.5	29	32	7.0	66.0
	NSNV-M406-13	M40 x 1.5	36	40	13.0	85.5
	NSNV-M406-7	M40 x 1.5	36	40	7.0	79.5
	NSNV-M409-13	M40 x 1.5	29	32	13.0	72.0
	NSNV-M508-14	M50 x 1.5	48	50	14.0	87.5
NSNV-M638-14	M63 x 1.5	48	50	14.0	84.0	

Approvals



For applications in railway vehicles and heavy machine construction
 Specially formulated polyamide 6
 Thread and integrated swivel adapter made from nickel-plated brass
 Very high impact resistance. High thread and system connection strength. Suitable for occasional rotation
 Easy introduction of wires and cables
 Vibration-proof connection to PMAFLEX conduit
 Very good chemical properties
 Free from halogens and cadmium
 Fits both conduit profiles – fine (T) and coarse (G)
 IP68, IP69

Type SNV - Swivel connector, straight, NPT metal thread

	Order no. IP68, black ^④	Thread NPT	Fits to conduit size		Thread length (mm)	Overall length (mm)
			NW	Metric		
	NSNV-N022/01	½"	12	16	15.4	58.0
	NSNV-N027/01	½"	17	20	15.4	66.5
	NSNV-N043/01	¾"	23	25	15.7	72.0
	NSNV-N069/01	1"	29	32	19.6	77.5
	NSNV-N076/01	1¼"	36	40	20.2	91.5
	NSNV-N088/01	1½"	48	50	20.6	92.0
	NSNV-N098/01	2"	48	50	21.4	93.0

Approvals



For applications with high technical requirements mainly in machine building
 Specially formulated polyamide 6
 Thread and integrated swivel adapter made from colourless anodized aluminium
 Very high impact resistance. High thread and system connection strength. Suitable for occasional rotation
 Easy introduction of wires and cables
 Vibration-proof connection to PMAFLEX conduit
 Very good chemical properties
 Free from halogens and cadmium
 Fits both conduit profiles – fine (T) and coarse (G)
 IP68, IP69

^④ IP68GT available. Please add
 "GT" prior to the thread length
 (for example NSBV-M329GT-13)

Swivel connectors with female NPT metal thread

Type SNIV & SBIV

Type SNIV - Swivel connector straight, female NPT metal thread, IP68

	Order no. black ⁴	Thread metric	Fits to conduit size		Thread length (mm)	Overall length (mm)
			NW	Metric		
	NSNIV-N022/01	½"	12	16	13.6	59.0
	NSNIV-N027/01	½"	17	20	13.6	67.0
	NSNIV-N043/01	¾"	23	25	14.1	72.5
	NSNIV-N069/01	1"	29	32	16.8	76.5
	NSNIV-N076/01	1¼"	36	40	17.3	91.5
	NSNIV-N088/01	1½"	48	50	17.3	93.5
	NSNIV-N098/01	2"	48	50	17.8	93.0

Approvals



For applications with high technical requirements mainly in machine building

Type SBIV - 360° Swivel connector, 90° curved elbow, IP68, female NPT metal thread

	Order no. IP68, black ⁴	Thread NPT	Fits to conduit size		Thread length (mm)	Overall length (mm)
			NW	Metric		
	NSWIV-N022/01	½"	12	16	13.6	48.5 x 46.5
	NSBIV-N027/01	½"	17	20	13.6	67.0 x 74.5
	NSBIV-N043/01	¾"	23	25	14.1	78.0 x 87.5
	NSBIV-N069/01	1"	29	32	16.8	91.0 x 98.0
	NSBIV-N076/01	1¼"	36	40	17.3	104.5 x 125.5
	NSBIV-N088/01	1½"	48	50	17.3	119.5 x 138.5
	NSBIV-N098/01	2"	48	50	17.8	119.0 x 138.5

Approvals



Technical requirements mainly in heavy machine building and rail applications
 Suitable for occasional rotation
 Specially formulated polyamide 6
 Thread and integrated swivel adapter made from colourless anodized aluminium
 Very high impact resistance
 High thread and system connection strength
 Suitable for occasional rotation
 Easy introduction of wires and cables
 Vibration-proof connection to PMAFLEX conduit
 Very good chemical properties
 Free from halogens and cadmium
 Fits both conduit profiles – fine (T) and coarse (G)
 IP68, IP69

⁴ IP68GT available. Please add "GT" prior to the thread length (for example NSBV-M329GT-13)

Flanges, connectors with female, metric thread

Type VO & VI

Type VO - Flange 90°

	Order no. IP66 ①	Order no. IP68 ① ②	Fits to conduit size		Width x Length x Depth (mm)	Screw sizes
			NW	Metric		
	BVOD-P167GT	BVOV-P167	17	20	46.0 x 66.0 x 35.5	2 x M5
	BVOD-P213GT	BVOV-P213	23	25	65.5 x 70.0 x 43.0	2 x M6
	BVOD-P299GT	BVOV-P299	29	32	67.0 x 78.0 x 49.5	4 x M6
	BVOD-P366GT	BVOV-P366	36	40	85.0 x 102.0 x 65.5	4 x M6
	BVOD-P488GT	BVOV-P488	48	50	86.0 x 119.0 x 77.5	4 x M6

For cable protection systems in a wide range of applications
 Flange seal FGO4 made from EPDM, flange seal FGO4/01 made from NBR
 Temperature range with FG04: -40°C to +105°C
 Temperature range with FG04/01: -25°C to +70°C

Type VI - Connector straight, female metric thread

	Order no. IP66, black	Order no. IP68, black ②	Thread metric	Fits to conduit size		Thread length (mm)	Overall length (mm)
				NW	Metric		
	BVID-M12MGT	-	M12 x 1.5	07	10	8.0	32.0
	BVID-M160GT	BVIR-M160	M16 x 1.5	10	12	8.0	33.5
	BVID-M162GT	BVIR-M162	M16 x 1.5	12	16	8.0	36.5
	-	BVIR-M202	M20 x 1.5	12	16	8.0	36.5
	BVID-M207GT	BVIR-M207	M20 x 1.5	17	20	8.0	44.5
	BVID-M253GT	BVIR-M253	M25 x 1.5	23	25	8.0	48.5
	-	BVIR-M257	M25 x 1.5	17	20	8.0	44.5
	BVID-M329GT	BVIR-M329	M32 x 1.5	29	32	10.0	51.5
	BVID-M406GT	BVIR-M406	M40 x 1.5	36	40	10.0	65.5
	BVID-M508GT	BVIR-M508	M50 x 1.5	48	50	10.0	65.5
	BVID-M638GT	BVIR-M638	M63 x 1.5	48	50	10.0	65.5

Approvals



For cable protection systems in a wide range of applications
 VID: IP66 static/IP54 dynamic, conduit side
 VIR: IP68 static/IP67 dynamic, conduit side
 No seal on female thread side

- ① Please replace "B" for black with "S" for grey in front of the order no.
 ② IP68GT available. Please add "GT" after the order no.

Connectors with female, metric metal thread

Type VIR

Type VIR - Connector straight, female metric metal thread

	Order no. IP68, black ②	Thread metric	Fits to conduit size		Thread length (mm)	Overall length (mm)
			NW	Metric		
	NVIR-M120	M12 x 1.5	10	12	7.5	35.0
	NVIR-M160	M16 x 1.5	10	12	9.0	40.5
	NVIR-M162	M16 x 1.5	12	16	9.0	42.0
	NVIR-M207	M20 x 1.5	17	20	10.0	50.0
	NVIR-M253	M25 x 1.5	23	25	10.0	56.0
	NVIR-M329	M32 x 1.5	29	32	11.0	55.5
	NVIR-M406	M40 x 1.5	36	40	13.0	71.0
	NVIR-M508	M50 x 1.5	48	50	15.0	75.0
	NVIR-M638	M63 x 1.5	48	50	17.5	76.0

Approvals



For applications in railway vehicles and heavy machine construction
 High thread and system connection strengths
 VIR: IP68 static/IP67 dynamic, conduit side
 No seal on female thread side

- ① Please replace "B" for black with "S" for grey in front of the order no.
- ② IP68GT available. Please add "GT" after the order no.

Connector straight, PG female thread

Type FIL/VIR & VIZR

Type FIL/VIR - Connector straight, female PG thread

	Order no. IP67, black	Order no. IP68, black ②	Thread PG	Fits to conduit size		Thread length (mm)	Overall length (mm)
				NW	Metric		
	BFIL-P07M	–	07	07	10	8.0	29.0
	BFIL-P070	–	07	10	12	8.0	34.5
	–	BVIR-P070	07	10	12	8.0	33.5
	BFIL-P090	–	09	10	12	8.0	32.5
	–	BVIR-P090	09	10	12	8.0	33.5
	BFIL-P112	–	11	12	16	8.0	32.5
	–	BVIR-P112	11	12	16	8.0	36.5
	BFIL-P117	–	11	17	20	8.0	35.0
	BFIL-P132	–	13.5	12	16	8.0	32.5
	BFIL-P137	–	13.5	17	20	8.0	33.5
	BFIL-P160	–	16	10	12	7.0	37.0
	BFIL-P167	–	16	17	20	8.0	33.5
	–	BVIR-P167	16	17	20	8.0	44.5
	BFIL-P217	–	21	17	20	10.5	35.5
	BFIL-P213	–	21	23	25	8.0	39.0
	BFIL-P293	–	29	23	25	9.0	42.0
	BFIL-P299	–	29	29	32	9.0	43.0
	BFIL-P363	–	36	23	25	12.0	51.0
	BFIL-P369	–	36	29	32	16.0	52.0
	BFIL-P366	–	36	36	25	13.0	64.0
BFIL-P488	–	48	48	50	13.0	65.0	

For cable protection systems in a wide range of applications

VIR: IP68 static/IP67 dynamic, conduit side

FIL: IP67 static/IP65 dynamic, conduit side

No seal on female thread side

Type VIZR - Connector straight, female PG metal thread

	Order no. IP68, black ②	Thread PG	Fits to conduit size		Thread length (mm)	Overall length (mm)
			NW	Metric		
	NVIZR-P07M	07	07	10	6.0	35.0
	NVIZR-P090	09	10	12	9.0	38.5
	NVIZR-P110	11	10	12	9.0	41.0
	NVIZR-P112	11	12	16	9.0	42.0
	NVIZR-P137	13.5	17	20	8.0	46.5
	NVIZR-P167	16	17	20	9.5	48.0
	NVIZR-P213	21	23	25	10.0	58.0
	NVIZR-P299	29	29	32	12.5	57.0
	NVIZR-P366	36	36	40	13.0	76.0
	NVIZR-P488	48	48	50	14.0	75.0

For applications in railway vehicles and heavy machine construction

High thread and system connection strengths

VIZR: IP68 static/IP67 dynamic, conduit side

No seal on female thread side

② IP68GT available. Please add
"GT" after the order no.

Connectors with female UNEF thread

Type VI

Type VI - Connector straight, UNEF female thread for AMP connectors

	Order no. IP66, black	Order no. IP68, black ②	Thread UNEF	Fits to conduit size		Thread length (mm)	Overall length (mm)
				NW	Metric		
	BVIDA-U15MGT	BVIRA-U15M	5/8"–24	07	10	8.0	31.5
	BVIDA-U150GT	BVIRA-U150	5/8"–24	10	12	8.0	33.5
	BVIDA-U152GT	BVIRA-U152	5/8"–24	12	16	8.0	36.5
	BVIDA-U180GT	BVIRA-U180	3/4"–20	10	12	8.0	33.5
	BVIDA-U182GT	BVIRA-U182	3/4"–20	12	16	8.0	36.5
	BVIDA-U187GT	BVIRA-U187	3/4"–20	17	20	8.0	44.5
	BVIDA-U232GT	BVIRA-U232	1 5/16"–20	12	16	8.0	38.5
	BVIDA-U237GT	BVIRA-U237	1 5/16"–20	17	20	8.0	46.5
	BVIDA-U233GT	BVIRA-U233	1 5/16"–20	23	25	8.0	48.5
	BVIDA-U347GT	BVIRA-U347	1 3/8"–18	17	20	8.0	46.5
	BVIDA-U343GT	BVIRA-U343	1 3/8"–18	23	25	8.0	48.5
	BVIDA-U402GT	BVIRA-U402	1 5/8"–18	12	16	7.0	55.5
	BVIDA-U407GT	BVIRA-U407	1 5/8"–18	17	20	7.0	61.5
	BVIDA-U403GT	BVIRA-U403	1 5/8"–18	23	25	7.0	60.5

For cable protection systems in a wide range of applications

Suitable for the AMP connector serie CPC

VIDA: IP66 static/IP54 dynamic, conduit side. VIRA: IP68 static/IP67 dynamic, conduit side

No seal on female thread side

Type VI - Connector straight, UNEF female thread for Souriau connectors

	Order no. IP66, black	Order no. IP68, black ②	Thread UNEF	Fits to NW	Shell size UTG-6	Thread length (mm)	Overall length (mm)
BVIDB-U202GT	BVIRB-U202	1 3/16"–20	12	14–12	4.5	44.0	
BVIDB-U232GT	BVIRB-U232	1 5/16"–20	12	16–19	4.5	49.0	
BVIDB-U237GT	BVIRB-U237	1 5/16"–20	17	16–19	4.5	52.0	
BVIDB-U267GT	BVIRB-U267	1 1/16"–18	17	18–23	4.5	52.0	
BVIDB-U297GT	BVIRB-U297	1 3/16"–18	17	20–28	6.5	55.5	
BVIDB-U293GT	BVIRB-U293	1 3/16"–18	23	20–28	6.5	52.0	
BVIDB-U323GT	BVIRB-U323	1 5/16"–18	23	22–35	6.5	52.0	
BVIDB-U357GT	BVIRB-U357	1 7/16"–18	17	24–48	6.5	58.5	
BVIDB-U353GT	BVIRB-U353	1 7/16"–18	23	24–48	6.5	54.0	
BVIDB-U359GT	BVIRB-U359	1 7/16"–18	29	24–48	6.5	50.5	

For cable protection systems in a wide range of applications

Suitable for the Souriau connector series UTG-6/ITT Cannon Trident

VIDB: IP66 static/IP54 dynamic, conduit side. VIRB: IP68 static/IP67 dynamic, conduit side

No seal on female thread side

	Order no. IP68, black ②	Thread UNEF	Fits to NW	Shell size UTG-6	Thread length (mm)	Overall length (mm)
	BVIRS-U162	1 1/16"–24	12	12	9.4	47.5
	BVIRS-U202	1 3/16"–20	12	14	9.4	47.5
	BVIRS-U237	1 5/16"–20	17	16	10.0	56.0
	BVIRS-U267	1 1/16"–18	17	18	9.2	55.5
	BVIRS-U293	1 3/16"–18	23	20	9.8	56.0
	BVIRS-U323	1 5/16"–18	23	22	9.8	56.0
	BVIRS-U359	1 7/16"–18	29	24	9.7	55.5

For cable protection systems in a wide range of applications

Suitable for the Souriau connector series UTO and UTS

VIRS: IP68 static/IP67 dynamic, conduit side. No seal on female thread side

② IP68GT available. Please add "GT" after the order no.

Connectors with female UN thread

Type VI

Type VI - Connector straight, UN female thread for MIL-C5015

	Order no. IP66, black	Order no. IP68, black ②	Thread UN	Fits to conduit size		Thread length (mm)	Overall length (mm)
				NW	Metric		
	-	BVIVG-U152*	5/8"-24 UNEF	12	16	8.0	36.5
	-	BVIVG-U187*	3/4"-20 UNEF	17	20	9.0	46.5
	-	BVIVG-U210*	7/8"-20 UNEF	10	07	9.0	37.0
	BVIDG-U212GT	BVIVG-U212*	7/8"-20 UNEF	12	16	9.0	38.5
	BVIDG-U217GT	BVIVG-U217*	7/8"-20 UNEF	17	20	9.0	46.5
	BVIDG-U242GT	BVIVG-U242*	1"-20 UNEF	12	16	9.0	40.5
	-	BVIVG-U243*	1"-20 UNEF	23	25	9.0	55.0
	BVIDG-U247GT	BVIVG-U247*	1"-20 UNEF	17	20	9.0	47.5
	-	BVIVG-U292*	1 3/16"-18 UNEF	12	16	9.0	40.5
	BVIDG-U293GT	BVIVG-U293*	1 3/16"-18 UNEF	23	25	9.0	55.0
	BVIDG-U297GT	BVIVG-U297*	1 3/16"-18 UNEF	17	20	9.0	47.5
	-	BVIVG-U299*	1 3/16"-18 UNEF	29	32	9.0	47.0
	-	BVIVG-U349*	1 3/8"-18 UNEF	29	32	9.0	52.0
	-	BVIVG-U352*	1 7/16"-18 UNEF	12	16	9.0	39.0
	BVIDG-U353GT	BVIVG-U353*	1 7/16"-18 UNEF	23	25	9.0	52.0
	-	BVIVG-U356*	1 7/16"-18 UNEF	36	40	9.0	63.0
	BVIDG-U357GT	BVIVG-U357*	1 7/16"-18 UNEF	17	20	9.0	46.5
	BVIDG-U359GT	BVIVG-U359*	1 7/16"-18 UNEF	29	29	9.0	52.0
	BVIDG-U433GT	BVIVG-U433*	1 3/4"-18 UNS	23	25	10.0	52.0
	BVIDG-U436GT	BVIVG-U436*	1 3/4"-18 UNS	36	40	10.0	62.5
	-	BVIVG-U437*	1 3/4"-18 UNS	17	20	10.0	46.5
	BVIDG-U439GT	BVIVG-U439*	1 3/4"-18 UNS	29	32	10.0	51.5
	-	BVIVG-U503*	2"-18 UNS	23	25	10.0	51.5
	BVIDG-U506GT	BVIVG-U506*	2"-18 UNS	36	40	10.0	62.5
	-	BVIVG-U508*	2"-18 UNS	48	50	10.0	64.5
	BVIDG-U509GT	BVIVG-U509*	2"-18 UNS	29	32	10.0	55.0
	-	BVIVG-U563*	2 3/4"-16 UN	23	25	10.0	51.0
	BVIDG-U566GT	BVIVG-U566*	2 3/4"-16 UN	36	40	10.0	62.0
-	BVIVG-U568*	2 3/4"-16 UN	48	50	10.0	64.0	
BVIDG-U569GT	BVIVG-U569*	2 3/4"-16 UN	29	32	10.0	51.0	
-	BVIVG-U628*	2 1/2"-16 UN	48	50	10.0	64.0	

Approvals



For applications in machine, vehicle and traction building industries

Suitable for MIL connector series C5015

VIDG: IP66 static/IP54 dynamic, conduit- and thread side

VIVG: IP68 static/IP67 dynamic, conduit- and thread side

No seal on female thread side

* UL Recognition according to UL 1619

② IP68GT available. Please add
"GT" after the order no.

Y, T pieces, conduit adapters

Type VY & VT

Type VY - Y piece

	Order no. IP66 ①	Order no. IP68 ① ②	1 x conduit size		2 x conduit size	
			NW	Metric	NW	Metric
	BVYD-100707GT	BVYR-100707	10	12	07	10
	BVYD-121010GT	BVYR-121010	12	16	10	12
	BVYD-171212GT	BVYR-171212	17	20	12	16
	BVYD-231717GT	BVYR-231717	23	25	17	20
	BVYD-292323GT	BVYR-292323	29	32	23	25
	BVYD-362929GT	BVYR-362929	36	40	29	32
	BVYD-483636GT	BVYR-483636	48	50	36	40

Approvals



Sizes can be adapted with AV conduit adapters to fit smaller conduit dimensions

Type VT - T piece

	Order no. IP66 ①	Order no. IP68 ① ②	3 x conduit size	
			NW	Metric
	BVTD-101010GT	BVTR-101010	10	12
	BVTD-121212GT	BVTR-121212	12	16
	BVTD-171717GT	BVTR-171717	17	20
	BVTD-232323GT	BVTR-232323	23	25
	BVTD-292929GT	BVTR-292929	29	32
	BVTD-363636GT	BVTR-363636	36	40
	BVTD-484848GT	BVTR-484848	48	50

Approvals



Sizes can be adapted with AV conduit adapters to fit smaller conduit dimensions

- ① Please replace "B" for black with "S" for grey in front of the order no.
- ② IP68GT available. Please add "GT" after the order no.

Y, T pieces, conduit adapters

Type AV

Type AV - Conduit adapter

	Order no. IP66, black	Order no. IP68, black	Fits to fitting for		Fits to fitting size		Overall length (mm)
			NW	Metric	NW	Metric	
AV	-	BAVR-10/07	10	12	07	10	43.0
	BAVD-12/10GT	BAVR-12/10	12	16	10	12	46.0
	BAVD-17/10GT	BAVR-17/10	17	20	10	12	53.0
	BAVD-17/12GT	BAVR-17/12	17	20	12	16	54.0
	BAVD-23/10GT	BAVR-23/10	23	25	10	12	54.0
	BAVD-23/12GT	BAVR-23/12	23	25	12	16	53.0
	BAVD-23/17GT	BAVR-23/17	23	25	17	20	62.0
	BAVD-29/10GT	BAVR-29/10	29	32	10	12	56.5
	BAVD-29/12GT	BAVR-29/12	29	32	12	16	55.0
	BAVD-29/17GT	BAVR-29/17	29	32	17	20	61.0
	BAVD-29/23GT	BAVR-29/23	29	32	23	25	64.0
	BAVD-36/29GT	BAVR-36/29	36	40	29	32	81.0
	BAVD-48/36GT	BAVR-48/36	48	50	36	40	88.5

Approvals



Allows conduit size reduction of PMA connectors, particularly of T and Y pieces

Connections, connection splices, metric, PG

Type VNR-REM & VSG

Type VNR-REM - Connection to solid metal tube, metric/PG

	Order no. IP68 without clamp ① ②	Order no. IP68 with clamp ① ②	Fits to conduit size		Steel tube metric	Inside Ø (mm)	Overall length (mm)
			NW	Metric			
	BVNR-REM162	BVNR-REM162-24	12	16	M16	16.0	54.0
	BVNR-REM187	BVNR-REM187-28	17	20	M18	18.5	65.0
	BVNR-REM207	BVNR-REM207-28	17	20	M20	20.0	65.0
	BVNR-REM253	BVNR-REM253-32	23	25	M25	26.0	71.0
	BVNR-REM329	BVNR-REM329-44	29	32	M32	32.0	71.0
	BVNR-REM406	BVNR-REM406-50	36	40	M40	40.0	90.0
	BVNR-REM508	BVNR-REM508-65	48	50	M50	50.0	90.0
	Order no. IP68 without clamp ① ②	Order no. IP68 with clamp ① ②	Fits to conduit size		Steel tube PG	Inside Ø (mm)	Overall length (mm)
			NW	Metric			
	BVNR-RE12	BVNR-RE12-24	12	16	PG11	18.5	56.0
	BVNR-RE1317	BVNR-RE1317-28	17	20	PG13	20.4	65.0
	BVNR-RE17	BVNR-RE17-28	17	20	PG16	22.5	65.0
	BVNR-RE23	BVNR-RE23-32	23	25	PG21	28.5	71.0
	BVNR-RE29	BVNR-RE29-44	29	32	PG29	37.0	71.0
	BVNR-RE36	BVNR-RE36-50	36	40	PG36	47.0	84.0
	BVNR-RE48	BVNR-RE48-65	48	50	PG48	59.3	90.0

Quick connection of solid metal tubes with flexible PMA conduit

Jubilee clip made of galvanised bright steel

Available with or without jubilee clip

IP68 on corrugated conduit side, on tube side up to IP68 with sealant

Type VSG - Connection splice for flexible conduit

	Order no. IP66 ①	Order no. IP68 ①	Fits to conduit size		Inside Ø (mm)	Overall length (mm)
			NW	Metric		
	BVSGD-1212GT	BVSGR-1212	12	16	23.5	66.0
	BVSGD-1717GT	BVSGR-1717	17	20	29.5	87.0
	BVSGD-2323GT	BVSGR-2323	23	25	37.0	103.0
	BVSGD-2929GT	BVSGR-2929	29	32	44.0	100.0
	BVSGD-3636GT	BVSGR-3636	36	40	53.5	130.0
	BVSGD-4848GT	BVSGR-4848	48	50	66.0	133.0

Approvals



Designed for optimal connection of PMA conduit

① Please replace "B" for black with "S" for grey in front of the order no.

② IP68GT available. Please add "GT" to order no. or insert before clamp size (e.g. BVNR-REM162GT, BVNR-REM162GT-24)

Special connectors

Introduction

Meet the demands of our customers.
We are always looking for ways to offer our best services.

In addition to the broad ranges of connectors offered within the PMAFIX Pro, PMAFIX and Smartline product lines, PMA offers further application specific connector solutions such as the MPNK-M series for high temperatures applications, JENQ-M series for Food and Beverage applications and the MONK-M to terminate an overbraided conduit.





Metal connectors, metric

Type MPNK & MONK

Type MPNK - Metal connector for PMA conduit, metric thread

	Order no. metal	Thread metric	Fits to conduit size NW	Fits to conduit size profile	Inside Ø min. (mm)	Thread length (mm)
	MPNK-M160	M16 x 1.5	10	T	12.0	12.0
	MPNK-M162	M16 x 1.5	12	T	12.0	12.0
	MPNK-M207	M20 x 1.5	17	T	15.8	14.0
	MPNK-M253	M25 x 1.5	23	G	19.0	15.0
	MPNK-M329	M32 x 1.5	29	G	26.5	18.0

For high temperature applications
 Suitable for high mechanical loads
 Nickel-plated brass
 Seals made from silicon
 Easy introduction of wires and cables
 Vibration-proof connection to PMAFLEX conduit
 Very good chemical properties
 IP68

Type MONK - Metal connector for overbraided conduit, metric thread

	Order no. metal	Thread metric	Fits to conduit size NW	Fits to conduit profile	Inside Ø min. (mm)	Thread length (mm)
	MONK-M162	M16 x 1.5	12	T	12.0	12.0
	MONK-M207	M20 x 1.5	17	T	16.0	14.0
	MONK-M253	M25 x 1.5	23	G	19.0	15.0
	MONK-M329	M32 x 1.5	29	G	26.5	18.0
	MONK-M406	M40 x 1.5	36	G	35.0	15.0
	MONK-M508	M50 x 1.5	48	G	45.0	16.0

For termination of overbraided conduit
 For high temperature applications and applications in areas with hot metal shavings and flying sparks
 Nickel-plated brass
 Seals made from silicon

Stainless steel liquid tight fitting

Type JENQ

Type JENQ - for overextruded conduit, IP69

	Order no.	Thread size metric	Fits to conduit size NW	Thread length (mm)	Inside Ø min. (mm)	Ø D (mm)	Wrench size (mm)	sw
	JENQ-M162-10	M16 x 1.5	12	10.0	9.2	31.9	35.9	30.0
	JENQ-M207-10	M20 x 1.5	17	10.0	13.0	35.0	36.9	32.0
	JENQ-M253-11	M25 x 1.5	23	11.0	18.3	44.5	41.6	40.0
	JENQ-M329-13	M32 x 1.5	29	13.0	24.0	55.5	48.7	50.0
	JENQ-M406-13	M40 x 1.5	36	13.0	32.4	61.5	51.2	57.0
	JENQ-M506-14	M50 x 1.5	48	14.0	42.3	78.0	57.4	74.0

Approvals



IP 69 rating
 For termination of overextruded conduit
 For high hygienic requirements
 Suitable for food & beverage industry
 Unique single piece design Stainless Steel 316L material
 Seals made from FDA compliant material
 Easy cleaning
 High thread and system connection strengths
 High resistance to chemicals and cleaning agents
 Easy assembly

Accessories

Introduction

For flexible and application friendly solutions. PMA offers a vast array of practical accessories in order to complete the PMA cable protection system.

We offer lock nuts produced from polyamide or metal, thread reducers and enlargers, conduit adapters, swivel adapters as well as different mounting clips for conduit. All this practical products will help to create the PMA line for our customers even more flexible and application friendly.





Flat gaskets, metric, PG, NPT, GAS

Type SVN4

Type SVN4 - Flat thread gasket, metric/NPT/PG/GAS

	Order no.	Fits to thread metric	Inside Ø (mm)	Outside Ø (mm)	Thickness (mm)
	SVN4-M12	M12 x 1.5	12.0	20.0	1.5
	SVN4-M12/02	M12 x 1.5	12.0	23.0	1.5
	SVN4-M16	M16 x 1.5	16.0	22.0	1.5
	SVN4-M16/02	M16 x 1.5	16.0	25.0	1.5
	SVN4-M20	M20 x 1.5	20.0	27.0	1.5
	SVN4-M20/02	M20 x 1.5	20.0	33.0	1.5
	SVN4-M25	M25 x 1.5	25.0	35.0	1.5
	SVN4-M25/01	M25 x 1.5	25.0	31.0	1.5
	SVN4-M25/02	M25 x 1.5	25.0	39.0	1.5
	SVN4-M32	M32 x 1.5	32.0	43.0	1.5
	SVN4-M32/02	M32 x 1.5	32.0	49.0	1.5
	SVN4-M40	M40 x 1.5	40.0	55.0	1.5
	SVN4-M40/01	M40 x 1.5	40.0	51.0	1.5
	SVN4-M40/02	M40 x 1.5	40.0	64.0	1.5
	SVN4-M50	M50 x 1.5	50.0	69.0	1.5
	SVN4-M50/01	M50 x 1.5	50.0	59.0	1.5
	SVN4-M50/02	M50 x 1.5	50.0	74.0	1.5
SVN4-M63	M63 x 1.5	63.0	75.0	1.5	

	Order no.	Fits to thread PG	Inside Ø (mm)	Outside Ø (mm)	Thickness (mm)
	SVN4-07	07	12.5	16.5	1.5
	SVN4-09	07	15.2	20.0	1.5
	SVN4-11	11	18.6	24.0	1.5
	SVN4-13	13.5	20.4	31.0	1.5
	SVN4-16	16	22.5	31.0	1.5
	SVN4-21	21	28.3	37.0	1.5
	SVN4-29	29	37.0	48.0	1.5
	SVN4-36	36	47.0	57.0	1.5
	SVN4-42	42	54.0	60.0	1.5
	SVN4-48	48	59.3	69.0	1.5

	Order no.	Fits to thread GAS	Inside Ø (mm)	Outside Ø (mm)	Thickness (mm)
	SVN4-G00	¼"	13.2	20.0	1.5
	SVN4-G01	⅜"	16.7	22.0	1.5
	SVN4-G02	½"	21.0	28.0	1.5
	SVN4-G04	¾"	26.5	34.0	1.5
	SVN4-G06	1"	33.3	42.0	1.5
	SVN4-G07	1¼"	41.9	53.0	1.5
	SVN4-G08	1½"	47.8	62.0	1.5
	SVN4-G09	2"	59.6	69.0	1.5

For sealing of polyamide or metal threads of PMA fittings

For ingress protection at the thread up to IP68

For solid sealing of uneven rough contact areas around the thread hole or when no constructive measures for O-Rings are provided

NBR reinforced with aramide fibres (asbestos-free)

Temperature range: -50°C to +200°C, short-term to +350°C

Note: Depending on flange sizes flat thread gaskets can have different widths. Please indicate fitting for which gasket is needed for replacement orders

Locking clips, water impact protection

Type AFN2, OVN2 & WPS

Type AFN2 - Universal safety clip

	Order no. dark grey	Fits to conduit size		Width (mm)	Length (mm)	Thickness (mm)
		NW	Profile			
	AFN2-07GT	07	G + T	14.0	14.0	7.0
	AFN2-10GT	10	G + T	17.5	17.0	8.0
	AFN2-12GT	12	G + T	20.5	20.0	7.3
	AFN2-17GT	17	G + T	26.5	22.0	8.0
	AFN2-23GT	23	G + T	34.0	27.5	11.8
	AFN2-29GT	29	G + T	40.5	32.0	11.8
	AFN2-36GT	36	G + T	50.0	39.0	9.5
	AFN2-48GT	48	G + T	62.0	47.0	9.5

Pre-installed in PMA connectors IP66 and IP68GT
Allows simple push-in assembly of PMA conduit

Type OVN2 - Oval clip

	Order no. dark grey	Fits to conduit size		Width (mm)	Length (mm)	Thickness (mm)
		NW	Profile			
	OVN2-07	07	G + T	14.0	14.0	6.0
	OVN2-10	10	G + T	17.5	17.0	7.0
	OVN2-12	12	G + T	21.0	19.0	6.0
	OVN2-17	17	G + T	26.5	22.5	7.0
	OVN2-23	23	G + T	34.0	27.5	10.5
	OVN2-29	29	G + T	40.5	32.0	10.5
	OVN2-36	36	G + T	49.5	39.0	8.5
	OVN2-48	48	G + T	62.0	47.0	8.5

Provides reliable fixation of PMA conduit within PMA IP68 fittings

Type WPS - Water impact protection

	Order no. black	Fits to conduit size		Outside Ø (mm)	Thickness (mm)
		NW	Profile		
	WPS-NW10	10	G + T	22.0	8.0
	WPS-NW12	12	G + T	26.0	8.0
	WPS-NW17	17	G + T	33.0	8.0
	WPS-NW23	23	G + T	40.0	9.0
	WPS-NW29	29	G + T	47.0	9.5
	WPS-NW36	36	G + T	59.0	10.0
	WPS-NW48	48	G + T	71.0	10.0

Increased protection of PMAFIX fittings against water jet impact – increased protection up to IP69

For increased ingress protection requirements regarding high pressure/steam jet cleaning

Based on PMAFIX IP68 system

Two-piece water impact protection with click cap

Retrofit installation possible

Sealing caps, reducers

Type NVN3, NFN3 & NR

Type NVN3 - Sealing cap, reinforced

	Order no.	Fits to conduit size		Length (mm)
		NW	Metric	
	NVN3-07	07	10	9.0
	NVN3-09	10	12	9.0
	NVN3-11	12	16	12.0
	NVN3-16	17	23	16.5
	NVN3-21	23	25	13.0
	NVN3-29	29	32	14.0
	NVN3-36	36	40	17.5
	NVN3-48	48	50	17.5

In connection with PMAFIX connectors („V“ series) and PMA corrugated conduit
 For ingress protection IP68 static/IP67 dynamic
 Specially modified polyesterelastomer
 Free from halogens and cadmium
 Fits both conduit profiles – fine (T) and coarse (G)
 Temperature range: –40°C to +105°C

Type NFN3 - Sealing cap

	Order no.	NW	Profile	Length (mm)
	NFN3-07	07	10	9.0
	NFN3-09	10	12	9.0
	NFN3-11	12	16	9.0
	NFN3-16	17	23	9.0
	NFN3-21	23	25	9.0
	NFN3-29	29	32	9.0
	NFN3-36	36	40	11.0
	NFN3-48	48	50	11.0

In connection with PMAFIX connectors („F“ series) and PMA corrugated conduit
 For ingress protection IP67 static/IP65 dynamic
 Specially modified polyesterelastomer
 Free from halogens and cadmium
 Fits conduit profiles – fine (T) and coarse (G)
 Temperature range: –40°C to +105°C

Type NR - Reducer, PG

	Order no.	Thread outside PG	Thread inside PG	Length (mm)	Inside Ø (mm)	Outside Ø (mm)
	1109N	11	09	22.5	10.5	24.5
	1309N	13.5	09	15.0	10.0	26.0
	1311N	13.5	11	24.0	11.5	26.0
	1609N	16	09	16.0	10.0	29.0
	1611N	16	11	16.0	11.5	29.0
	1613N	16	13.5	27.0	13.5	29.0
	2113N	21	13.5	16.0	13.5	35.5
	2116N	21	16	16.0	15.5	35.5
	2921N	29	21	17.0	22.0	43.0
	3629N	36	29	24.0	30.5	54.0

Reduction of threaded or clearance holes to smaller PG thread sizes
 High-grade, glass fibre reinforced Polyamid 6
 Temperature range: –30°C to +100°C

Enlargers, reducers, metric

Type ME & MR

Type ME - Enlarger, brass, metric thread

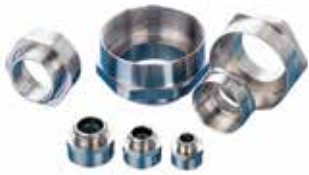
	Order no.	Thread outside		Thread inside		Wrench size (mm)	Inside Ø (mm)	Overall length (mm)
		Metric	Length (mm)	Metric	Length (mm)			
	M12M16M	M12 x 1.5	5.0	M16 x 1.5	7.0	18	8.0	16.0
	M16M20M	M16 x 1.5	5.0	M20 x 1.5	7.5	22	12.0	16.5
	M20M25M	M20 x 1.5	6.0	M25 x 1.5	8.0	27	15.0	18.5
	M25M32M	M25 x 1.5	7.0	M32 x 1.5	9.0	34	21.0	20.5
	M32M40M	M32 x 1.5	8.0	M40 x 1.5	10	42	26.0	23.5
	M40M50M	M40 x 1.5	8.0	M50 x 1.5	13	52	34.0	30.0
	M50M63M	M50 x 1.5	9.0	M63 x 1.5	16	65	44.0	32.5

For enlargement of an existing thread
 Nickel-plated brass
 Hexagonal form
 Temperature range: -60°C to +200°C

Type MR - Reducer, brass, metric thread

	Order no. standard	Order no. hexagonal	Thread outside metric	Thread inside metric
	M20M12M	M20M12M/6	M20 x 1.5	M12 x 1.5
	M20M16M	M20M16M/6	M20 x 1.5	M16 x 1.5
	M25M16M	M25M16M/6	M25 x 1.5	M16 x 1.5
	M25M20M	M25M20M/6	M25 x 1.5	M20 x 1.5
	M32M20M	M32M20M/6	M32 x 1.5	M20 x 1.5
	M32M25M	M32M25M/6	M32 x 1.5	M25 x 1.5
	M40M25M	M40M25M/6	M40 x 1.5	M25 x 1.5
	M40M32M	M40M32M/6	M40 x 1.5	M32 x 1.5
	M50M32M	M50M32M/6	M50 x 1.5	M32 x 1.5
	M50M40M	M50M40M/6	M50 x 1.5	M40 x 1.5
	M63M40M	M63M40M/6	M63 x 1.5	M40 x 1.5
	M63M50M	M63M50M/6	M63 x 1.5	M50 x 1.5

Reduction of threaded or clearance holes to smaller thread sizes
 Nickel-plated brass
 Temperature range: -60°C to +200°C
 Round form without O-ring, hexagonal form with O-ring

Enlargers, reducers, PG

Type ME & MR

Type ME - Enlarger, brass, PG thread

	Order no. metal, standard	Thread outside		Thread inside		Outside Ø (mm)	Overall length (mm)
		PG	Length (mm)	PG	Length (mm)		
	0709M	07	5.0	09	07	17.0	15.0
	0911M	09	6.0	11	07	20.0	16.5
	0913M	09	6.0	13	7.5	22.0	17.5
	1113M	11	6.0	13	08	22.0	17.5
	1116M	11	6.5	16	8.5	24.0	19.0
	1121M	11	6.5	21	10	30.0	21.0
	1316M	13.5	6.5	16	7.5	24.0	19.0
	1321M	13.5	6.5	21	8.5	30.0	21.0
	1621M	16	6.5	21	8.5	30.0	21.0
	1629M	16	6.5	29	11	39.0	22.5
	2129M	21	7.0	29	11.5	39.0	23.0
	2936M	29	8.0	36	12	50.0	27.5
	4248M	42	10.0	48	17	64.0	33.0

For enlargement of an existing thread
 Nickel-plated brass
 Temperature range: -60°C to +200°C

Type MR - Reducer, brass, PG thread

	Order no. metal, standard	Thread outside		Thread inside PG	Outside Ø (mm)	Overall length (mm)
		PG	Length (mm)			
	0907M	09	6.0	07	17.0	8.5
	1107M	11	6.0	07	20.0	8.5
	1109M	11	6.0	09	20.0	8.5
	1307M	13.5	6.5	07	22.0	9.0
	1309M	13.5	6.5	09	22.0	9.0
	1311M	13.5	6.5	11	22.0	9.0
	1607M	16	6.5	07	24.0	9.5
	1609M	16	6.5	09	24.0	9.5
	1611M	16	6.5	11	24.0	9.5
	1613M	16	6.5	13.5	24.0	9.5
	2111M	21	7.0	11	30.0	10.0
	2113M	21	7.0	13.5	30.0	10.0
	2116M	21	7.0	16	30.0	10.0
	2916M	29	8.0	16	39.0	11.5
	2921M	29	8.0	21	39.0	11.5
	3621M	36	9.0	21	50.0	12.5
	3629M	36	9.0	29	50.0	12.5
	4229M	42	10	29	57.0	14.0
	4236M	42	10	36	57.0	14.0
	4836M	48	10	36	64.0	14.0
4842M	48	10	42	64.0	14.0	

Reduction of threaded or clearance holes to smaller thread sizes
 Nickel-plated brass
 Temperature range: -60°C to +200°C

Plug screws, metric, PG

Type 514

Type 514 - Plug screw, metric/PG thread

	Order no. grey	Fits to thread metric	Outside Ø (mm)	Height (mm)	Thread length (mm)
	514-M12	M12 x 1.5	15.0	10.0	6.0
	514-M16	M16 x 1.5	20.0	10.5	6.0
	514-M20	M20 x 1.5	24.0	10.5	6.0
	514-M25	M25 x 1.5	30.0	13.0	8.0
	514-M32	M32 x 1.5	37.0	13.5	8.0
	514-M40	M40 x 1.5	46.0	14.0	8.0
	514-M50	M50 x 1.5	56.0	16.5	10.0
	514-M63	M63 x 1.5	70.0	17.0	12.0

	Order no. grey	Fits to thread PG	Outside Ø (mm)	Height (mm)	Thread length (mm)
	514-07	07	15.0	10.0	6.0
	514-09	09	19.0	10.0	6.0
	514-11	11	22.0	10.0	6.0
	514-13	13.5	25.0	10.0	6.0
	514-16	16	27.0	10.0	6.0
	514-21	21	33.0	12.5	8.0
	514-29	29	44.5	13.0	8.0
	514-36	36	55.5	15.0	10.0
	514-48	48	69.5	17.0	12.0

For closing off unused threaded holes
 Polyamide 6 glass fibre reinforced
 Free from halogens and cadmium
 IP54
 Temperature range: -30°C to +100°C

Lock nuts, metric, PG

Type MN

Type MN - Hexagonal lock nut, polyamide, metric/PG thread

	Order no. black	Order no. grey	Fits to thread metric	Wrench size (mm)	Height (mm)
MN 	BMN-M12	GMN-M12	M12 x 1.5	17	5.0
	BMN-M16	GMN-M16	M16 x 1.5	22	5.0
	BMN-M20	GMN-M20	M20 x 1.5	26	5.6
	BMN-M25	GMN-M25	M25 x 1.5	32	6.0
	BMN-M32	GMN-M32	M32 x 1.5	41	7.0
	BMN-M40	GMN-M40	M40 x 1.5	50	7.0
	BMN-M50	GMN-M50	M50 x 1.5	60	8.0
	BMN-M63	GMN-M63	M63 x 1.5	75	8.0

	Order no. black	Order no. grey	Fits to thread PG	Wrench size (mm)	Height (mm)
	BMN-07	GMN-07	07	19	5.0
	BMN-09	GMN-09	09	22	5.0
	BMN-11	GMN-11	11	24	5.0
	BMN-13	GMN-13	13.5	27	6.0
	BMN-16	GMN-16	16	30	6.0
	BMN-21	GMN-21	21	36	7.0
	BMN-29	GMN-29	29	46	7.0
	BMN-36	GMN-36	36	60	8.0
	BMN-48	GMN-48	48	70	8.0

Glass fibre reinforced Polyamid 6
High tightening torques

Lock nuts, metric, PG

Type MM

Type MM - Hexagonal lock nut, brass, metric/PG thread

	Order no.	Fits to thread metric	Wrench size (mm)	Height (mm)
MM 	GMM-M12	M12 x 1.5	15	2.8
	GMM-M16	M16 x 1.5	19	2.8
	GMM-M20	M20 x 1.5	24	3.0
	GMM-M25	M25 x 1.5	30	3.5
	GMM-M32	M32 x 1.5	36	4.0
	GMM-M40	M40 x 1.5	46	4.5
	GMM-M50	M50 x 1.5	60	5.0
	GMM-M63	M63 x 1.5	70	5.5

	Order no.	Fits to thread PG	Wrench size (mm)	Height (mm)
	GMM-07	07	15	2.8
	GMM-09	09	18	2.8
	GMM-11	11	21	3.0
	GMM-13	13.5	23	3.0
	GMM-16	16	26	3.0
	GMM-21	21	32	3.5
	GMM-29	29	41	4.0
	GMM-36	36	51	5.0
	GMM-42	42	60	5.0
	GMM-48	48	64	5.5

Nickel-plated brass
 Maximum possible torque
 Safe system connection

System supports, half-shells

Type VH & GN

Type VH - System support

	Order no. support ①	Order no. clip ①	Order no. complete ①	Fits to conduit size		Width x Height x Depth (mm)	Fixing screws
				NW	Metric		
	BVH-17-010	BVH-17-020	BVH-17-000	17	20	35 x 36 x 36	6 x M5
	BVH-23-010	BVH-23-020	BVH-23-000	23	25	35 x 44 x 36	6 x M5
	BVH-29-010	BVH-29-020	BVH-29-000	29	32	46 x 52 x 40	6 x M5
	BVH-36-010	BVH-36-020	BVH-36-000	36	40	53 x 58 x 60	6 x M5
	BVH-48-010	BVH-48-020	BVH-48-000	48	50	66 x 72 x 60	6 x M5

For applications in machine building and installation
 Optimal axial strain relief due to integrated rib
 Variable fixation possible due to six holes, safe against turning
 With safety lid suitable for overhead installation
 High retention forces
 PA 6

Type GN - Half shell

	Order no. fine profile, black	Order no. coarse profile, black	Fits to conduit size		Outside Ø (mm)	Width (mm)
			NW	Metric		
	BGN-S12T	–	12	16	26.5	34.0
	BGN-S17T	BGN-S17G	17	20	32.0	34.0
	BGN-S23T	BGN-S23G	23	25	39.5	34.0
	BGN-S29T	BGN-S29G	29	32	47.0	34.0
	BGN-S36T	–	36	40	55.0	36.5
	–	BGN-S36G	36	40	55.0	34.0
	BGN-S48T	–	48	50	66.5	36.5
	–	BGN-S48G	48	50	66.5	34.0
	–	BGN-S70G	70	80	93.5	38.0

For conduit fixation in conjunction with beam systems, particularly in traction and machine applications
 Fixes conduit against axial movements
 Allows radial turning of conduit
 Especially suitable for dynamic applications due to rounded edges
 PA 6

System supports, rails for system supports

Type FH-0 & FHS

Type FH-0 - System support, one-piece

	Order no. black	Order no. grey	Fits to conduit size		Width x Height x Depth (mm)	Fixing screws
			NW	Metric		
	BFH-07-0	SFH-07-0	07	10	17.0 x 21.5 x 20.0	1 x M4
	BFH-10-0	SFH-10-0	10	12	20.5 x 24.5 x 20.0	1 x M5
	BFH-12-0	SFH-12-0	12	16	24.0 x 27.0 x 20.0	1 x M5
	BFH-17-0	SFH-17-0	17	20	30.0 x 34.0 x 20.0	1 x M6
	BFH-23-0	SFH-23-0	23	25	38.5 x 42.0 x 20.0	1 x M6
	BFH-29-0	SFH-29-0	29	32	45.5 x 48.0 x 20.0	1 x M6
	BFH-36-0	SFH-36-0	36	40	55.5 x 56.0 x 20.0	1 x M6
	BFH-48-0	SFH-48-0	48	50	67.5 x 68.0 x 20.0	1 x M6

For applications in machine building and installation
 Optimal axial strain relief due to integrated rib
 Suitable for overhead installations due to safety lid
 High retention forces
 Quick mounting due to single hole fixing
 Fits to rail for system support FHS
 PA 6

Type FHS - Rail for system support

	Order no. black	Order no. grey	Fits to system supports	Length x Height x Depth (mm)
FHS	BFHS-00	SFHS-00	FH-NW-0	275.0 x 15.5 x 25.0
Additional position supports or distance spacers				
	BFHS-PH	SFHS-PH	Position support with screws	
	BFHS-PH1	SFHS-PH1	Distance spacers	

For flexible assembly of one-piece system supports and/or fixation of various conduit sizes
 Glass fibre reinforced polyamide 6
 Extremely robust construction
 High stiffness
 Positioning and distance spacers available
 Glass fibre reinforced PA6

Tube clamps

Type GL & GH

Type GL - Tube clamp, one-piece

	Order no. black	Order no. grey	Fits to conduit size		Width (mm)	Fixing screws
			NW	Metric		
	BGL-07	SGL-07	07	10	25.0	1 x M4
	BGL-10	SGL-10	10	12	27.0	1 x M4
	BGL-12	SGL-12	12	16	31.0	1 x M4
	BGL-17	SGL-17	17	20	39.5	1 x M5
	BGL-23	SGL-23	23	25	49.0	1 x M5
	BGL-29	SGL-29	29	32	57.0	1 x M6

Used in general machine and installation applications
 Integrated rib provides axial strain relief
 Allows turning of the conduit, thus avoiding torsion stresses
 Pre-fixation on the conduit possible
 PA 6

Type GH - Tube clamp, one-piece

	Order no. black	Order no. grey	Thread outside		Width (mm)	Fixing screws
			NW	Metric		
	BGH-23	SGH-23	23	25	16.0	2 x M5
	BGH-29	SGH-29	29	32	19.0	2 x M6
	BGH-36	SGH-36	36	40	24.0	2 x M6
	BGH-48	SGH-48	48	50	24.0	2 x M6
	BGH-56	SGH-56	56	68	26.0	2 x M8
	BGH-70	SGH-70	70	80	30.0	2 x M8
	BGH-95	SGH-95	95	106	30.0	2 x M8

Used in general machine and installation applications
 Integrated rib provides axial strain relief
 Allows turning of the conduit, thus avoiding torsion stresses
 Pre-fixation on the conduit possible
 Allows solid fixation with 2 screws
 PA 6

Tube clamps

Type SGB & SGS

Type SGB - Tube clamp

	Order no. black	Fits to conduit size		Width (mm)	Fixing screws
		NW	Metric		
	SGB-07	07	10	13.0	1 x M4
	SGB-09	10	12	13.0	1 x M4
	SGB-11	12	16	13.0	1 x M4
	SGB-16	17	20	16.0	1 x M5
	SGB-21	23	25	16.0	1 x M5
	SGB-29	29	32	19.0	1 x M6
	SGB-36	36	40	19.0	1 x M6
	SGB-48	48	50	19.0	1 x M6

For fixation of static conduit

Galvanized steel

Elastomer profile (EPDM) free from halogens

Smooth connection to PMA conduit

Good resistance to ozone and ageing

Temperature range: -40°C to +120°C

Type SGS - Tube clamp

	Order no. black	Fits to conduit size		Width x Height x Depth (mm)	Fixing screws
		NW	Metric		
	SGS-36	36	40	80.0 x 48.0 x 19.0	2 x M6
	SGS-48	48	50	94.0 x 58.0 x 19.0	2 x M6
	SGS-56	56	68	118.0 x 72.0 x 24.0	2 x M8
	SGS-70	70	80	130.0 x 85.0 x 24.0	2 x M8
	SGS-95	95	106	156.0 x 110.0 x 24.0	2 x M8
	SGS-125	125	146	200.0 x 152.0 x 24.0	2 x M8

For fixation of static conduit

Galvanized steel

Elastomer profile (EPDM) free from halogens

Smooth connection to PMA conduit

Good resistance to ozone and ageing

Temperature range: -40°C to +120°C

Galvanized steel/EPDM

System supports

Type GPS, GP & BGP-3x48

Type GPS - System support, one-piece, stackable

	Order no.	Fits to conduit size			Width (mm)	Height (mm)	Depth (mm)
		NW	Metric	DIN-NW			
	BGPS-12/01*	12	16	2	70.0	51.0	30.0
	BGPS-17	17	20	2	70.0	51.0	30.0
	BGPS-23	23	25	2	70.0	51.0	30.0
	BGPS-29	29	32	3	85.0	65.0	30.0
	BGPS-36	36	40	3	85.0	65.0	30.0
	BGPS-48	48	50	4	115.0	92.5	30.0
	BGPS-56	56	68	4	115.0	92.5	30.0

* This size will be delivered with a half-shell insert

In railway vehicle construction, heavy machine building industry and other applications with increased mechanical requirements

Heavy design, high retention forces. Applicable with standard metal C rails

Clasp for easy pre-mounting and final assembly. Especially suitable for dyn. applic. due to rounded edges

The following nominal widths can be combined for stacking: NW 12 with NW 17 + 23, NW 17 with NW 23,

NW 29 with NW 36, NW 48 with NW 56

Content of delivery: System support and 2 screws for securing of the lid (optional); without mounting accessories

PA 6

Type GP - System support, stackable

	Order no. ①	Thread outside		Width (mm)	Height (mm)	Depth (mm)
		NW	Metric			
	BGP-12/01*	12	16	48.0	66.0	36.0
	BGP-17	17	20	48.0	66.0	36.0
	BGP-23	23	25	48.0	66.0	36.0
	BGP-29	29	32	62.0	66.0	36.0
	BGP-36	36	40	62.0	66.0	36.0
	BGP-48	48	50	76.0	66.0	36.0
	BGP-56G	56	68	87.0	78.0	36.0

*This size will be delivered with a half-shell insert

In railway vehicle construction, heavy machine building industry and other applications with increased mechanical requirements

Variable stacking possibilities, due to the "Block"-system a high rigidity is guaranteed

Fixes conduit against axial movements. Allows radial turning of conduit

Especially suitable for dyn. applic. due to rounded edges. Variety of support possibilities

Content of delivery: System support with assembling screws; without mounting accessories

PA 6

Type BGP-3x48- Multiple system support

	Order no.	Thread outside			Width (mm)	Height (mm)	Length (mm)
		NW	Metric	Profile			
	BGP-3x48	48	50	G and T	30.0	84.0	214.0

In railway vehicle construction, heavy machine building industry and other applications with increased mechanical requirements

Multiple system support for 3 x NW48 max. conduit

Axial fixation of conduit. Conduit rotation possible (avoids torsion)

Especially suitable for dynamic applications due to rounded edges

PA 6

① Please replace "B" for black with "S" for grey in front of the order no.

Conduit terminations

Type RKS & CT

Type RKS - Conduit terminal sleeve

	Order no. black	Fits to conduit size		Inside Ø (mm)	Outside Ø (mm)	Length (mm)
		NW	Metric			
	RKS-07	07	10	4.5	12.5	16.0
	RKS-10	10	12	8.0	15.5	16.0
	RKS-12	12	16	10.0	19.0	20.0
	RKS-17	17	20	13.0	24.0	21.0
	RKS-23	23	25	20.0	32.0	22.0
	RKS-29	29	32	25.0	38.0	22.0
	RKS-36	36	40	33.0	46.0	25.0
	RKS-48	48	50	45.0	58.0	25.0
	RKS-56	56	68	54.0	71.0	28.0

For clean conduit end termination where no fitting is required
PA 6

Type CT - Conduit termination

	Order no. black	Fits to conduit size		Clamping range (mm)	Length (mm)	Height (mm)
		NW	Metric			
	BCT-10	10	12	4-8	28.0	13.0
	BCT-12	12	16	5-9	35.0	16.0
	BCT-17	17	20	7-14	42.0	21.0
	BCT-23	23	25	14-22	51.0	28.0
	BCT-29	29	32	16-22	53.0	34.0
	BCT-36	36	40	16-29	55.0	42.0

For sealing of cables and wires at the exit from PMA corrugated conduit
Avoids ingress of dirt and liquids
Can be fixed additionally with cable ties
Neoprene rubber
Temperature range: -30°C to +120°C

Abrasion protection sleeves, tools

Type SS/SV & EWZ

Type SS/SV - Abrasion protection sleeve

	Order no.	Fits to conduit size		Outside Ø (mm)	Length (mm)
		NW	Metric		
	BSS-17	17	20	42.0	22.0
	BSS-23	23	25	49.0	26.0
	BSS-29	29	32	55.0	26.0
	BSS-36	36	40	63.0	30.0
	BSS-48	48	50	75.0	30.0
	BSS-56G	56	68	90.0	33.0
	BSV-70G	70	80	108.0	60.0

Abrasion protection for corrugated conduit in positions exposed to chafing
Increases the life time of moving conduit
PA 6

Type EWZ - Draw-in tool

	Order no. black with hole	Order no. black with handle	Fits to conduit size NW	Width x Length x Depth (mm)
EWZ	EWZ-02	EWZ-03	7.5-34	117.7 x 45.2 x 71.9



Suitable for drawing in cables or wires into PMA Divisible System conduit or other slit conduit
Designed in a handy shape and equipped with a practical hand grip for wedging or with hole for direct holding of the wires
Polyamide 6.6
Colour: black

Tools

Type PMACUT

Type PMACUT - Cutting tool for conduit, NW 07–48

	Order no. Cutting tool	Order no. Spare blade	Cutting range	For conduit size NW
PMACUT	PMACUT-38	FP-38	0–38	07–29
	PMACUT-52	FP-52	0–52	23–48



Can be used to cut all PMA conduit
 Enables a precise and straight cut around the corrugation
 Metal
 Colour: Red

Type PMACUT - Cutting tool for conduit, NW 56–125

PMACUT	Order no. black	Fits to conduit size		Length x Width x Depth (mm)
		NW	Metric	
	PMACUT-NW56	56	68	337 x 101 x 15
	PMACUT-NW70	70	80	350 x 110 x 15
	PMACUT-NW95	95	106	400 x 142 x 20
	PMACUT-NW125	125	146	443 x 182 x 20

Can be used to cut all PMA conduit with large nominal widths
 Enables a precise and straight cut at the top of the corrugation
 High level of safety through retractable blade
 Aluminium

Elbow adapters, metric

Type MAVI & MAVIK

Type MAVI - Special 45° elbow adapter, metric thread

	Order no.	Thread metric		Thread length outside (mm)	Outside Ø (mm)	Overall length (mm)
		Inside	Outside			
	MAVI-M20/01	M20 x 1.5	M20 x 1.5	10.0	35.0	45.0
	MAVI-M25/01	M25 x 1.5	M25 x 1.5	11.0	39.0	51.0
	MAVI-M32/01	M32 x 1.5	M32 x 1.5	13.0	46.0	54.0
	MAVI-M40/01	M40 x 1.5	M40 x 1.5	13.0	55.0	62.0
	MAVI-M50/01	M50 x 1.5	M50 x 1.5	14.0	65.0	75.0
	MAVI-M63/01	M63 x 1.5	M63 x 1.5	14.0	80.0	84.0

... connection with PMA connectors, especially connectors with strain relief VNZ

Enables different mounting positions: With a lock nut behind a clearance hole / In threaded holes (lock nut on MAVI side for positioning) / With SCA spin-coupler

Nickel-plated aluminium (other materials e.g. stainless steel or nickel-plated brass available on request)

High thread and system connection strength

IP68 static/IP67 dynamic

Temperature range: -60°C to +105°C

Type MAVIK - Positioning 45° elbow adapter, metric thread

	Order no.	Thread metric		Thread length outside (mm)	Outside Ø (mm)	Overall length (mm)
		Inside	Outside			
	MAVIK-M20/01	M20 x 1.5	M20 x 1.5	10.0	35.0	52.0
	MAVIK-M25/01	M25 x 1.5	M25 x 1.5	11.0	39.0	58.0
	MAVIK-M32/01	M32 x 1.5	M32 x 1.5	13.0	46.0	61.0
	MAVIK-M40/01	M40 x 1.5	M40 x 1.5	13.0	55.0	69.5
	MAVIK-M50/01	M50 x 1.5	M50 x 1.5	14.0	65.0	83.0
	MAVIK-M63/01	M63 x 1.5	M63 x 1.5	14.0	80.0	92.0

Where a certain cable outlet angle is required

In connection with PMA connectors, especially connectors with strain relief VNZ

The counter nut allows accurate positioning of the outlet direction in threaded holes

Adapter made from nickel-plated aluminium (other materials e.g. stainless steel or nickel-plated brass available on request), counter nut made from nickel-plated brass

High thread and system connection strength

IP68 static/IP67 dynamic

Temperature range: -60°C to +105°C

Swivel and positioning adapters, metric, PG

Type SWA & SCA

Type SWA - Swivel adapter with special sealing, metric/PG metal thread

	Order no.	Thread metric	Thread length (mm)	Outside Ø (mm)	Overall length (mm)
	SWA-M16-10	M16 x 1.5	10.0	23.0	37.5
	SWA-M20-10	M20 x 1.5	10.0	27.0	38.5
	SWA-M25-11	M25 x 1.5	11.0	32.0	41.0
	SWA-M32-13	M32 x 1.5	13.0	45.0	46.5
	SWA-M40-13	M40 x 1.5	13.0	55.0	47.5
	SWA-M50-14	M50 x 1.5	14.0	59.0	49.5
	SWA-M63-14	M63 x 1.5	14.0	75.0	52.0

	Order no.	Thread PG	Thread length (mm)	Outside Ø (mm)	Overall length (mm)
	SWA-P09	09	15.0	23.0	44.5
	SWA-P11	11	15.0	27.0	45.5
	SWA-P16	16	15.0	32.0	48.0
	SWA-P21	21	15.0	40.0	51.0
	SWA-P29	29	15.0	50.0	52.0
	SWA-P36	36	15.0	59.0	55.0
	SWA-P48	48	15.0	70.0	55.0

Allow PMA connectors to swivel freely in applications where such movement is occasionally necessary

In connection with PMA connectors with metal thread

Nickel-plated brass

With thread edge protection

IP68 and IP69

Temperature range: -40°C to +105°C

Type SCA - Positioning adapter, metric/PG metal thread

	Order no.	Thread metric	Thread length (mm)	Outside Ø (mm)	Overall length (mm)
	SCA-M16-10	M16 x 1.5	10.0	22.0	32.0
	SCA-M20-10	M20 x 1.5	10.0	26.0	33.0
	SCA-M25-11	M25 x 1.5	11.0	32.0	35.0
	SCA-M32-13	M32 x 1.5	13.0	39.0	39.5
	SCA-M40-13	M40 x 1.5	13.0	50.0	41.0
	SCA-M50-14	M50 x 1.5	14.0	59.0	43.5
	SCA-M63-14	M63 x 1.5	14.0	75.0	45.5

	Order no.	Thread PG	Thread length (mm)	Outside Ø (mm)	Overall length (mm)
	SCA-P09	09	12.0	22.0	35.0
	SCA-P11	11	12.0	26.0	36.0
	SCA-P16	16	13.0	29.0	38.0
	SCA-P21	21	14.0	39.0	41.0
	SCA-P29	29	14.0	44.0	42.5
	SCA-P36	36	17.0	59.0	49.0
	SCA-P48	48	17.0	69.0	50.5

Allows easy positioning of elbow connectors with metal thread

In connection with PMA connectors with metal thread (Metric: Metal long thread)

Nickel-plated brass

High fastening torque

With thread edge protection

P68 and IP69

Temperature range: -40°C to +105°C

PMA JUMBO sizes

General technical details

Larger sizes for big solutions. When you need conduit with larger sizes for your cable protection, we provide you with a comprehensive selection of large size conduit including connectors and flanges.

The PMA JUMBO product line includes a range of large size cable protection products. Seven different conduit types using a variety of raw materials to provide optimal performance in various applications and compatible fittings.

- PMA JUMBO conduit polyamide and polyurethane conduit in the large nominal width sizes NW56, 70, 95, 125
(PA6 conduit – PCL, CYL, VCS, VOH)
(PA12 conduit – PIS, PCS)
(PU conduit – PUE)
- PMAGRIP flange and threaded fittings plus accessories BGG (straight), BGO (90°) flange fittings achieve a sealing rating of IP50 and IP65 with a conduit sealing ring BGGV (straight), BGOV (90°) flange fittings achieve a sealing rating of IP68

Material

- Conduit made from specially formulated PA6, PA12 and PU
- Fittings made from specially formulated polyamide 6
- Self-extinguishing
- Free from halogens, REACH + RoHS compliant*
- Very good chemical properties
- Temperature range:
PA6 –40°C to +105°C, short-term to +160°C
PA12 –40°C to +95°C, short-term to +150°C
PU –60°C to +50°C

Characteristics

- Excellent conduit pull-out strength
- High impact resistance
- All PMA Jumbo conduit have a coarse (G) profile
- The conduit types PIS and VCS are UL recognized in jumbo sizes for use with the flange type fittings.

* All conduit are REACH and RoHS compliant











Conduit, large sizes

Type PMAFLEX JUMBO conduit

Type PMAFLEX JUMBO conduit

	Order no. black	Order no. grey	Conduit size		Inside Ø (mm)	Outside Ø (mm)	Stat./Dyn. radius (mm)	PU meter
			NW	Metric				
PMAFLEX JUMBO conduit	PCLG-56B	PCLG-56S	56	68	56.3	67.2	130/-	30
	PCLG-70B	PCLG-70S	70	80	67.5	80.0	160/-	10
	PCLG-95B	PCLG-95S	95	106	91.5	106.0	210/-	10
	PCLG-125B	PCLG-125S	125	146	126.5	146.5	450/-	6
	PIHG-56B	PIHG-56S	56	68	56.3	67.2	110/270	30
	PIHG-70B	PIHG-70S	70	80	67.2	79.6	150/350	30
	PIHG-95B	PIHG-95S	95	106	91.3	106.0	170/450	30
	PIHG-125B	PIHG-125S	125	146	126.5	146.5	350/480	20
	VCSG-56B	VCSG-56S	56	68	56.1	67.2	150/-	30
	VCSG-70B	VCSG-70S	70	80	66.5	80.0	200/-	10
	VCSG-95B	VCSG-95S	95	106	91.0	106.0	300/-	10
	LLPAG-56B	LLPAG-56S	56	68	56.3	67.2	120/-	30
	LLPAG-70B	LLPAG-70S	70	80	68.0	80.0	160/-	10
	LLPAG-95B	LLPAG-95S	95	106	91.9	106.0	210/-	10
	LLPAG-125B	LLPAG-125S	125	146	126.5	146.5	450/-	6
	VOHG-56B	VOHG-56S	56	68	55.5	67.2	135/-	10
	VOHG-70B	VOHG-70S	70	80	67.0	80.0	200/-	10
	VOHG-95B	VOHG-95S	95	106	90.5	106.0	300/-	10
	VOHG-125B	VOHG-125S	125	146	126.0	146.5	480/-	6
	PCSG-56B	PCSG-56S	56	68	56.1	67.2	130/280	30
	PCSG-70B	PCSG-70S	70	80	66.5	80.0	170/360	10
	PCSG-95B	PCSG-95S	95	106	91.0	106	250/470	10
	PUEG-56B	-	56	68	56.3	67.2	90/170	30
	PUEG-70B	-	70	80	68.2	80.5	100/220	30

Approvals



For further conduit and other sizes see conduit guide

PMAGRIP flange connectors

Type GG & GO

Type GG - Flange straight

	Order no. black	Order no. grey	Fits to conduit size		Width (mm)	Height (mm)	Depth (mm)
			NW	Metric			
GG	BGG-56	SGG-56	56	68	82.0	97.0	42.0
	BGG-70	SGG-70	70	80	97.0	114.0	48.0
	BGG-95	SGG-95	95	106	126.0	146.0	53.0
	BGG-125	SGG-125	125	146	-	194.0	79.0



Approvals



Ingress protection: IP50 without conduit seal ring (IP65 with conduit seal ring)
 Flange seal FGO4 made from EPDM, standard for indoor and outdoor applications
 Flange seal FGO4/01 made from NBR, optional for indoor applications with special chemical requirements
 Temperature range with FGO4: -40°C to +105°C
 Temperature range with FGO4/01: -25°C to +70°C
 Content of delivery: Flange part, fixation clamps (incl. 2 screws), flange seal (FGO4 or FGO4/01), conduit seal ring (optional for IP65)

Type GO - Flange 90° elbow

	Order no. black	Order no. grey	Fits to conduit size		Width (mm)	Height (mm)	Depth (mm)
			NW	Metric			
GO	BGO-56	SGO-56	56	68	82.0	97.0	101.0
	BGO-70	SGO-70	70	80	97.0	114.0	115.0
	BGO-95	SGO-95	95	106	126.0	146.0	149.0



Approvals



Ingress protection: IP50 without conduit seal ring (IP65 with conduit seal ring)
 Flange seal FGO4 made from EPDM, standard for indoor and outdoor applications
 Flange seal FGO4/01 made from NBR, optional for indoor applications with special chemical requirements
 Temperature range with FGO4: -40°C to +105°C
 Temperature range with FGO4/01: -25°C to +70°C
 Content of delivery: Flange part, fixation clamps (incl. 2 screws), flange seal (FGO4 or FGO4/01), conduit seal ring (optional for IP65)

PMAGRIP flange connectors

Type GGV & GOV

Type GGV - Flange straight

	Order no. black, IP68	Fits to conduit size		Width (mm)	Height (mm)	Depth (mm)
		NW	Metric			
GGV	BGGV-56	56	68	82.0	97.0	42.0
	BGGV-70	70	80	97.0	114.0	48.0
	BGGV-95	95	106	126.0	146.0	53.0



Approvals



In railway vehicle construction as well as in a wide range of industrial applications with high sealing and safety requirements
 Flange seal FGO4 made from EPDM, standard for indoor and outdoor applications
 Flange seal FGO4/01 made from NBR on request, optional for indoor applications with special chemical requirements
 Ingress protection: IP68, IP69 with conduit sealing NVN3
 Temperature range with FG04: -40°C to +105°C
 Temperature range with FG04/01: -25°C to +70°C
 If the application temperature is above 70°C we recommend to use an additional internal conduit support sleeve (BES)
 Content of delivery: Flange part, fixation clamps (incl. 2 screws), conduit seal (NVN3), flange seal (FGO4 or FGO4/01)

Type GOV - Flange 90° elbow

	Order no. black, IP68	Fits to conduit size		Width (mm)	Height (mm)	Depth (mm)
		NW	Metric			
GOV	BGOV-56	56	68	82.0	97.0	101.0
	BGOV-70	70	80	97.0	114.0	115.0
	BGOV-95	95	106	126.0	146.0	149.0



Approvals



In railway vehicle construction as well as in a wide range of industrial applications with high sealing and safety requirements
 Flange seal FGO4 made from EPDM, standard for indoor and outdoor applications
 Flange seal FGO4/01 made from NBR on request, optional for indoor applications with special chemical requirements
 Ingress protection: IP68, IP69 with conduit sealing NVN3
 Temperature range with FG04: -40°C to +105°C
 Temperature range with FG04/01: -25°C to +70°C
 If the application temperature is above 70°C we rec. to use an additional internal conduit support sleeve (BES)
 Content of delivery: Flange part, fixation clamps (incl. 2 screws), conduit seal (NVN3), flange seal (FGO4 or FGO4/01)

PMAGRIP threaded connectors

Type GG & GI

Type GG - Connector straight with locking clamps, metric/PG thread

	Order no. black	Order no. grey	Thread	Fits to conduit size		Thread length (mm)	Outside Ø (mm)	Overall length (mm)
				NW	Metric			
GG	BGG-M6356	SGG-M6356	M63 x 1.5	56	68	18.0	98.0	57.5
	BGG-P3656	SGG-P3656	PG 36	56	68	18.0	98.0	57.3



Ingress protection: IP50 without conduit seal ring (IP65 with conduit seal ring)
 Content of delivery: Threaded part, fixation clamps (incl. 2 screws), conduit seal ring (optional for IP65)

Type GI - Connector straight with locking clamps, metric female thread

	Order no. black	Order no. grey	Thread	Fits to conduit size		Thread length (mm)	Outside Ø (mm)	Overall length (mm)
				NW	Metric			
GI	BGI-M7556	SBI-M7556	M75 x 1.5	56	68	15.0	98.0	53.3



Ingress protection: IP50 without conduit seal ring (IP65 with conduit seal ring)
 Content of delivery: Threaded part, fixation clamps (incl. 2 screws), conduit seal ring (optional for IP65)

Tube clamps, conduit seal rings, large size accessories

Type GH & SGS

Type GH - Tube clamp, one-piece

	Order no. black	Order no. grey	Fits to conduit size		Width (mm)	Fixing screw
			NW	Metric		
GH 	BGH-56	SGH-56	56	68	26.0	2 x M8
	BGH-70	SGH-70	70	80	30.0	2 x M8
	BGH-95	SGH-95	95	106	30.0	2 x M8

For general machine and installation applications
 Integrated rib provides axial strain relief
 Allows turning of the conduit thus avoiding torsion stresses
 Pre-fixation on the conduit possible
 Allows solid fixation with 2 screws
 For other sizes of BGH tube clamps please see page 6/14
 PA 6

Type SGS - Tube clamp

	Order no.	Fits to conduit size		Width x Height x Depth (mm)	Fixing screw
		NW	Metric		
SGS 	SGS-36	36	40	80.0 x 48.0 x 19.0	2 x M6
	SGS-48	48	50	94.0 x 58.0 x 19.0	2 x M6
	SGS-56	56	68	118.0 x 72.0 x 24.0	2 x M8
	SGS-70	70	80	130.0 x 85.0 x 24.0	2 x M8
	SGS-95	95	106	156.0 x 110.0 x 24.0	2 x M8
	SGS-125	125	146	200.0 x 152.0 x 24.0	2 x M8

For fixation of static conduit
 Galvanized steel
 Elastomer profile (EPDM) free from halogens
 Smooth connection to PMA conduit
 Good resistance to ozone and ageing
 Temperature range: -40°C to +120°C

Tube clamps, conduit seal rings, large size accessories

Type SGO3

Type SGO3 - Conduit seal ring

	Order no.	Fits to conduit size		Inside Ø (mm)	Outside Ø (mm)	Thickness (mm)
		NW	Metric			
SGO3	SGO3-56	56	68	49.5	61.0	1.5
	SGO3-70	70	80	61.5	74.0	1.5
	SGO3-95	95	106	86.0	102.0	1.5
	SGO3-125	125	146	122.0	142.0	2.0



Used at the conduit end for sealing between the PMAGRIP flanges GG/GO/GI and PMA JUMBO conduit
 Nitrile rubber NBR
 Temperature range: -40°C to +105°C

PMA Divisible System

General technical details

One-piece Divisible System. The ideal solution for repairs, retrofit and pre-loomed applications. Equally all PMA conduit are compatible.

PMA offers a divisible system based upon PMA standard nominal widths.

This allows free combination of the PACOF and PPCOF divisible conduit with PMAFIX Pro, PMAFIX and PMA Smart Line fittings. Using the PMA Divisible System Fittings repairs can be easily made to existing installations without disconnecting cables. Equally all PMA conduit – also slit – are compatible with the fittings of the divisible system.

Material

- Conduit made from spec. formulated PA 6 and Polypropylene
- Fittings made from specially formulated polyamide 6
- Colour: Black
- Free from halogens, REACH + RoHS compliant
- Temperature range:
Conduit: -40°C to $+160^{\circ}\text{C}$
Connectors: -40°C to min. $+105^{\circ}\text{C}$

Characteristics

- Fast installation
- Conduit can be installed in fitting prior to closing the fitting
- High impact resistance
- High conduit pull-out strength
- Fits conduit profiles – fine (T) and coarse (G)





Conduit

Type PACOF & PPCOF

Type PACOF - Flexible, divisible

	Order no. black	Fits to conduit size		Inside Ø (mm)	Outside Ø (mm)	Stat. radius (mm)	PU meter
		NW	Metric				
	PACOF-07B	07	10	5.6	10.0	30	50
	PACOF-10B	10	12	8.5	12.8	33	50
	PACOF-12B	12	16	11.0	15.6	35	50
	PACOF-17B	17	20	15.5	21.1	45	50
	PACOF-23B	23	25	22.1	28.4	70	50
	PACOF-29B	29	32	27.2	34.5	120	50
	PACOF-36B	36	40	32.0	42.4	145	30
	PACOF-48B	48	50	43.9	54.1	150	30
	PACOF-70B	70	80	62.0	79.0	190	10

PACOF Index

min.	max.	
Ductility		Can be opened and closed again in longitudinal direction any time
Fatigue reversed bending		Good ductility
Compression resistance		Good compression resistance
Low temperature performance		Free from halogens, REACH + RoHS compliant
Weathering resistance		Temperature range: -40°C to +105°C, short-term to +160°C IP50

Type PPCOF - Flexible, divisible

	Order no. black	Fits to conduit size		Inside Ø (mm)	Outside Ø (mm)	Stat. radius (mm)	PU meter
		NW	Metric				
	PPCOF-07B	07	10	5.6	10.0	25	50
	PPCOF-10B	10	12	8.5	12.8	28	50
	PPCOF-12B	12	16	11.0	15.6	35	50
	PPCOF-17B	17	20	15.1	21.1	45	50
	PPCOF-23B	23	25	22.1	28.4	60	50
	PPCOF-29B	29	32	26.6	34.5	100	50
	PPCOF-36B	36	40	31.8	42.4	120	30
	PPCOF-48B	48	50	43.9	54.1	140	30
	PPCOF-70B	70	80	60.5	78.0	200	10

PPCOF Index

min.	max.	
Ductility		Can be opened and closed again in longitudinal direction any time
Fatigue reversed bending		Good reversed bending resistance
Compression resistance		Temperature range: -20°C to +105°C, short-term to +150°C
Low temperature performance		IP50
Weathering resistance		

Connectors, lock nuts

Type LNO & LN

Type LNO - Divisible connector straight, one-piece, metric thread

	Order no. black	Thread metric	Fits to conduit size		Thread length (mm)	Overall length (mm)
			NW	Metric		
	BLNO-M160	M16 x 1.5	10	12	13.0	37.5
	BLNO-M162	M16 x 1.5	12	16	13.0	39.5
	BLNO-M202	M20 x 1.5	12	16	13.0	39.5
	BLNO-M207	M20 x 1.5	17	20	13.0	43.5
	BLNO-M257	M25 x 1.5	17	20	14.0	44.5
	BLNO-M253	M25 x 1.5	23	25	14.0	52.5
	BLNO-M323	M32 x 1.5	23	25	17.0	56.0
	BLNO-M329	M32 x 1.5	29	32	17.0	61.0
	BLNO-M409	M40 x 1.5	29	32	21.0	65.0
	BLNO-M406	M40 x 1.5	36	40	22.0	74.5
	BLNO-M508	M50 x 1.5	48	50	22.0	80.5

Divisible connector straight, one-piece, metric thread

Compatible with PMA standard, slit and divisible conduit with standard nominal widths

In industries, plant construction, machine building as well as in house and electrical installations

For retrofit installation or repair

IP54

Special: Push-in installation of conduit into pre-installed fitting also possible

Type LN - Divisible lock nut, metric thread

	Order no. black	Thread metric	Fits with divisible connector		Wrench size (mm)	Width (mm)
			BLNO-M160	BLNO-M162		
	BLN-M16	M16 x 1.5	BLNO-M160	BLNO-M162	22.0	8.0
	BLN-M20	M20 x 1.5	BLNO-M202	BLNO-M207	26.0	8.0
	BLN-M25	M25 x 1.5	BLNO-M257	BLNO-M253	32.0	9.0
	BLN-M32	M32 x 1.5	BLNO-M323	BLNO-M329	41.0	12.0
	BLN-M40	M40 x 1.5	BLNO-M409	BLNO-M406	50.0	15.0
	BLN-M50	M50 x 1.5	BLNO-M508		60.0	15.0

Compatible with divisible PMA connectors, type BLNO

For retrofit installation or repair

Temperature range: -40°C to +100°C, short-term: +130°C

T, Y pieces, connection splice

Type LTO & LYO

Type LTO - Divisible T piece, one-piece

	Order no. black, IP40	3x conduit sizes	
		NW	Metric
	BLTO-070707	07	10
	BLTO-101010	10	12
	BLTO-121212	12	16
	BLTO-171717	17	20
	BLTO-232323	23	25
	BLTO-292929	29	32

Compatible with PMA standard, slit and divisible conduit with standard nominal widths
 In industries, plant construction, machine building as well as in house and electrical installations
 For retrofit installation or repair
 IP40
 Conduit can be installed in fitting prior to closing the fitting

Type LYO - Divisible Y piece, one-piece

	Order no. black, IP40	1x conduit size		2x conduit sizes	
		NW	Metric	NW	Metric
	BLYO-100707	10	12	07	10
	BLYO-121010	12	16	10	12
	BLYO-171212	17	20	12	16
	BLYO-231717	23	25	17	20
	BLYO-292917	17	20	29	32

Compatible with PMA standard, slit and divisible conduit with standard nominal widths
 In industries, plant construction, machine building as well as in house and electrical installations
 For retrofit installation or repair
 IP40
 Conduit can be installed in fitting prior to closing the fitting

T, Y pieces, connection splice

Type LSGO

Type LSGO - One-piece, divisible

	Order no. black, IP40	Fits to conduit size NW	Overall length (mm)	Outer Ø (mm)
LSGO	BLSGO-101010	10	36	16
	BLSGO-121212	12	36	21
	BLSGO-171717	17	38	26
	BLSGO-232323	23	39	33



Compatible with PMA standard, slit and divisible conduit with standard nominal widths
 In industries, plant construction, machine building as well as in house and electrical installations
 For retrofit installation or repair
 Polyamide (Nylon) 66
 IP40 rated

PMA Smart Line IP66

General technical details

Modern, versatile and attractive. Functional and modern design at an excellent value for money. Suitable for machine building, installation and construction industries.

One-piece design, IP66 protection and simple, fast installation are the outstanding features of the Smart Line. Other characteristics including a modern, functional design and an excellent price/performance ratio make this product line a very attractive solution.

Material

- Fittings made from specially formulated polyamide 6
- Self-extinguishing
- Free from halogens, REACH + RoHS compliant
- Temperature range:
–45°C to +105°C, short-term to +150°C

Characteristics

- High impact resistance
- Good conduit pull-out strength
- Vibration-proof connection to PMA conduit
- Fits conduit profiles – fine (T) and coarse (G)
- To avoid accidental opening, disassembling only possible with a screwdriver





PMA Smart Line

General technical details



—
Patent

—
IP66

IP66 static

IP54 dynamic

- One piece fitting
- Conical sealing method
- Integrated sealing lip in thread flange
- Easy "push-in" installation
- Ready for installation (fitting gets delivered with engaged locking elements)

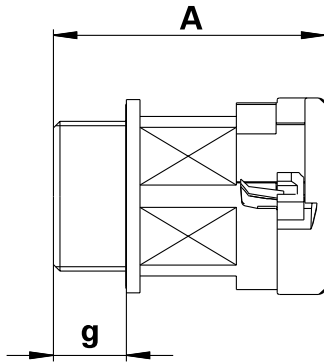

g = Thread length A = Overall length

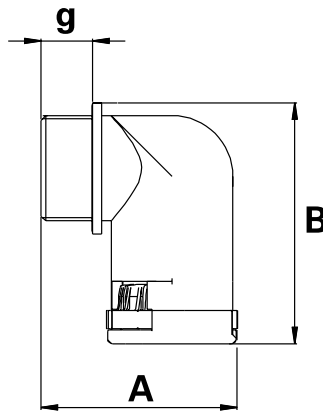
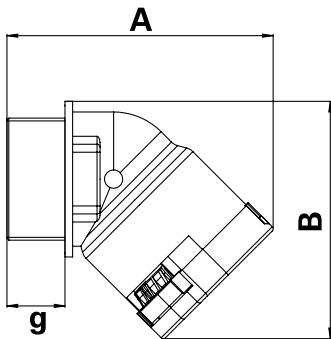

g = Thread length A x B = External dimensions

PMA Smart Line

Part number codes

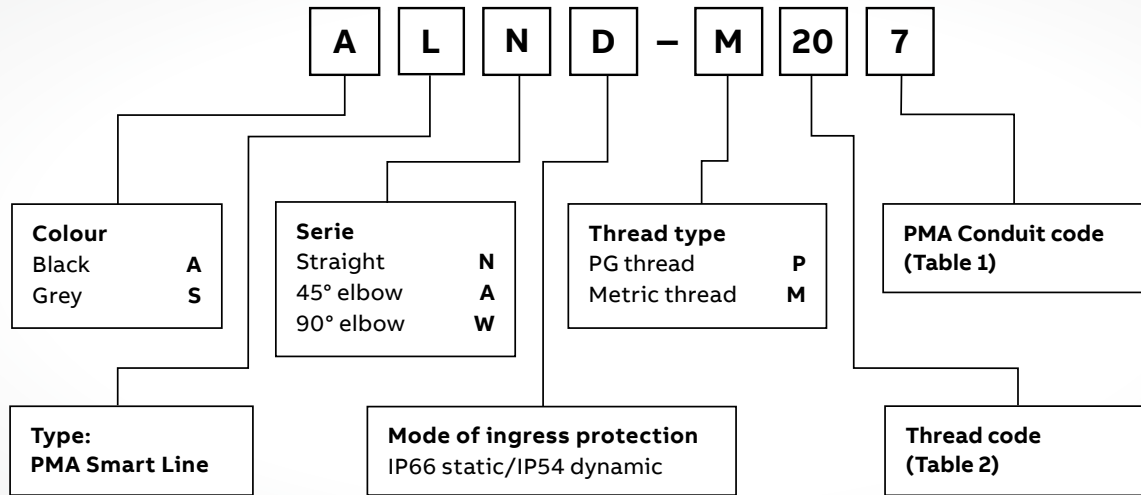

Connector series

- 01 Straight (N)
- 02 45° elbow (A)
- 03 90° elbow (W)

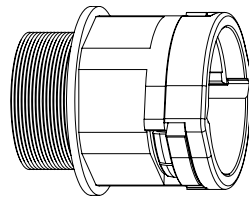

— 01

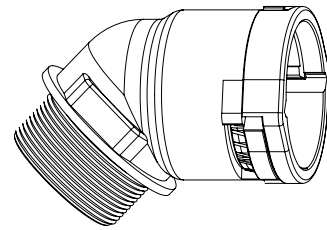

— 02

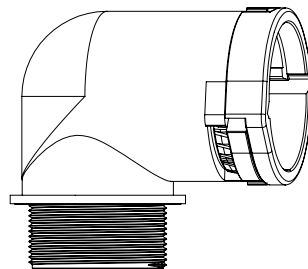

— 03

PMA Smart Line

Size codes, installation

Table 1: Conduit codes

Nominal width	Metric size	PMA code
07	10	M
10	12	0
12	16	2
17	20	7
23	25	3
29	32	9
36	40	6
48	50	8

Table 2: Thread codes

Thread Metric	PMA code
M12 x 1.5	M12
M16 x 1.5	M16
M20 x 1.5	M20
M25 x 1.5	M25
M32 x 1.5	M32
M40 x 1.5	M40
M50 x 1.5	M50
M63 x 1.5	M63

Thread PG	PMA code
PG07	P07
PG09	P09
PG11	P11
PG13.5	P13
PG16	P16
PG21	P21
PG29	P29
PG36	P36
PG48	P48

Installation IP66

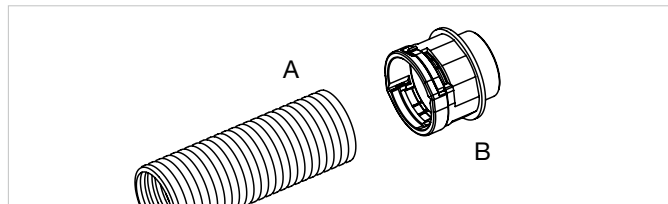

01

A = Conduit
B = Fitting

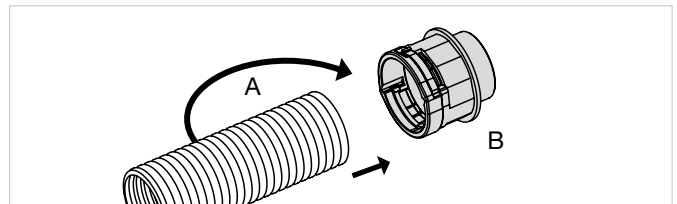

02

Push in the conduit (A) with a slight twist until the stop.

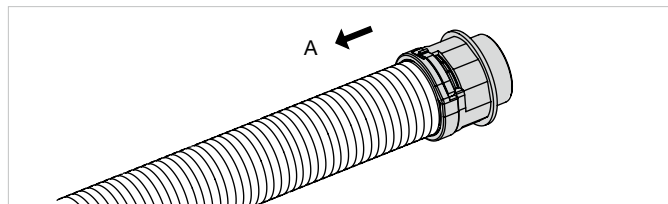

03

Pull back the conduit (A) slightly to ensure the locking mechanism is fully engaged.

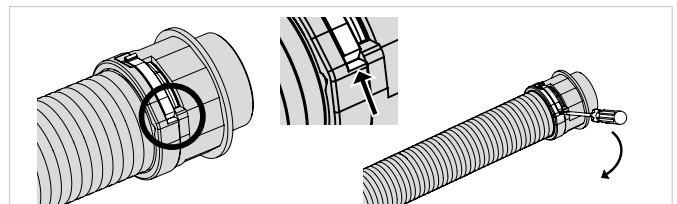

04

To disengage the locking mechanism use a size 1 screwdriver.

Connectors, metric, polyamide thread

Type LND & LAD

Type LND - Connector straight, metric thread

	Order no. black, IP66	Order no. grey, IP66	Thread metric	Fits to conduit size		Thread length (mm)	Overall length (mm)
				NW	Metric		
LND, patent 	ALND-M120	SLND-M120	M12 x 1.5	10	12	11.0	34.0
	ALND-M160	SLND-M160	M16 x 1.5	10	12	11.0	34.0
	ALND-M162	SLND-M162	M16 x 1.5	12	16	11.0	38.0
	ALND-M200	SLND-M200	M20 x 1.5	10	12	11.0	34.0
	ALND-M202	SLND-M202	M20 x 1.5	12	16	11.0	38.0
	ALND-M207	SLND-M207	M20 x 1.5	17	20	11.0	41.0
	ALND-M257	SLND-M257	M25 x 1.5	17	20	12.0	42.0
	ALND-M253	SLND-M253	M25 x 1.5	23	25	12.0	45.5
	ALND-M323	SLND-M323	M32 x 1.5	23	25	15.0	48.5
	ALND-M329	SLND-M329	M32 x 1.5	29	32	15.0	50.5
	ALND-M409	SLND-M409	M40 x 1.5	29	32	19.0	54.5
	ALND-M406	SLND-M406	M40 x 1.5	36	40	19.0	60.5
	ALND-M506	SLND-M506	M50 x 1.5	36	40	19.0	61.0
	ALND-M508	SLND-M508	M50 x 1.5	48	50	19.0	61.0
	ALND-M638	SLND-M638	M63 x 1.5	48	50	19.0	61.0

Type LAD - Connector 45° elbow, metric thread

	Order no. black, IP66	Order no. grey, IP66	Thread metric	Fits to conduit size		Thread length (mm)	External Dimensions (mm)
				NW	Metric		
LAD, patent 	ALAD-M120	SLAD-M120	M12 x 1.5	10	12	11.0	42.5 x 33.0
	ALAD-M160	SLAD-M160	M16 x 1.5	10	12	11.0	42.5 x 35.0
	ALAD-M162	SLAD-M162	M16 x 1.5	12	16	11.0	47.5 x 39.5
	ALAD-M202	SLAD-M202	M20 x 1.5	12	16	11.0	47.5 x 41.5
	ALAD-M207	SLAD-M207	M20 x 1.5	17	20	11.0	54.0 x 46.0
	ALAD-M257	SLAD-M257	M25 x 1.5	17	20	12.0	55.0 x 48.5
	ALAD-M253	SLAD-M253	M25 x 1.5	23	25	12.0	63.5 x 55.5
	ALAD-M323	SLAD-M323	M32 x 1.5	23	25	15.0	67.0 x 60.0
	ALAD-M329	SLAD-M329	M32 x 1.5	29	32	15.0	72.5 x 63.5
	ALAD-M409	SLAD-M409	M40 x 1.5	29	32	19.0	76.5 x 66.5
	ALAD-M406	SLAD-M406	M40 x 1.5	36	40	19.0	87.5 x 78.0
	ALAD-M506	SLAD-M506	M50 x 1.5	36	40	19.0	88.0 x 82.0
	ALAD-M508	SLAD-M508	M50 x 1.5	48	50	19.0	97.5 x 88.0
	ALAD-M638	SLAD-M638	M63 x 1.5	48	50	19.0	97.5 x 94.5

Connectors, metric and PG, polyamide thread

Type LWD & LND

Type LWD - Connector 90° elbow, metric thread

	Order no. black, IP66	Order no. grey, IP66	Thread metric	Fits to conduit size		Thread length (mm)	External dimensions (mm)
				NW	Metric		
LWD, patent 	ALWD-M120	SLWD-M120	M12 x 1.5	10	12	11.0	33.0 x 36.5
	ALWD-M160	SLWD-M160	M16 x 1.5	10	12	11.0	33.0 x 38.5
	ALWD-M162	SLWD-M162	M16 x 1.5	12	16	11.0	37.5 x 43.0
	ALWD-M202	SLWD-M202	M20 x 1.5	12	16	11.0	37.5 x 45.0
	ALWD-M207	SLWD-M207	M20 x 1.5	17	20	11.0	42.0 x 50.5
	ALWD-M257	SLWD-M257	M25 x 1.5	17	20	12.0	43.0 x 53.0
	ALWD-M253	SLWD-M253	M25 x 1.5	23	25	12.0	52.5 x 59.0
	ALWD-M323	SLWD-M323	M32 x 1.5	23	25	15.0	56.0 x 62.5
	ALWD-M329	SLWD-M329	M32 x 1.5	29	32	15.0	62.5 x 69.0
	ALWD-M409	SLWD-M409	M40 x 1.5	29	32	19.0	66.5 x 72.0
	ALWD-M406	SLWD-M406	M40 x 1.5	36	40	19.0	76.0 x 83.0
	ALWD-M506	SLWD-M506	M50 x 1.5	36	40	19.0	76.0 x 87.0
	ALWD-M508	SLWD-M508	M50 x 1.5	48	50	19.0	89.0 x 92.5
	ALWD-M638	SLWD-M638	M63 x 1.5	48	50	19.0	89.0 x 99.0

Type LND - Connector straight, PG thread

	Order no. black, IP66	Order no. grey, IP66	Thread PG	Fits to conduit size		Thread length (mm)	Overall length (mm)
				NW	Metric		
LND, patent 	ALND-P070*	SLND-P070*	07	10	12	7.0	44.0
	ALND-P090	SLND-P090	09	10	12	11.0	34.0
	ALND-P092*	SLND-P092*	09	12	16	8.0	50.0
	ALND-P110	SLND-P110	11	10	12	8.0	45.5
	ALND-P112	SLND-P112	11	12	16	11.0	38.0
	ALND-P132	SLND-P132	13.5	12	16	11.0	38.0
	ALND-P137	SLND-P137	13.5	17	20	11.0	41.0
	ALND-P167	SLND-P167	16	17	20	11.0	41.0
	ALND-P213	SLND-P213	21	23	25	12.0	45.5
	ALND-P299	SLND-P299	29	29	32	12.0	47.5
	ALND-P366	SLND-P366	36	36	40	13.0	54.5
	ALND-P488	SLND-P488	48	48	50	13.0	55.0

*These products will be delivered with a thread adapter

Connectors, PG, polyamide thread

Type LAD & LWD conduit

Type LAD - Connector 45° elbow, PG thread

	Order no. black, IP66	Order no. grey, IP66	Thread PG	Fits to conduit size		Thread length (mm)	External dimensions (mm)
				NW	Metric		
LAD, patent 	ALAD-P090	SLAD-P090	09	10	12	11.0	42.5 x 34.0
	ALAD-P112	SLAD-P112	11	12	16	11.0	47.5 x 40.0
	ALAD-P132	SLAD-P132	13.5	12	16	11.0	47.5 x 41.5
	ALAD-P137	SLAD-P137	13.5	17	20	11.0	54.0 x 46.0
	ALAD-P167	SLAD-P167	16	17	20	11.0	54.0 x 47.0
	ALAD-P213	SLAD-P213	21	23	25	12.0	63.5 x 57.5
	ALAD-P299	SLAD-P299	29	29	32	12.0	69.5 x 65.0
	ALAD-P366	SLAD-P366	36	36	40	13.0	81.5 x 80.0
	ALAD-P488	SLAD-P488	48	48	50	13.0	91.5 x 93.0

Type LWD - Connector 90° elbow, PG thread

	Order no. black, IP66	Order no. grey, IP66	Thread PG	Fits to conduit size		Thread length (mm)	External dimensions (mm)
				NW	Metric		
LWD, patent 	ALWD-P070*	SLWD-P070*	07	10	12	7.0	42.0 x 37.5
	ALWD-P090	SLWD-P090	09	10	12	11.0	32.5 x 37.5
	ALWD-P092*	SLWD-P092*	09	12	16	8.0	48.0 x 43.5
	ALWD-P110*	SLWD-P110*	11	10	12	8.0	44.0 x 40.0
	ALWD-P112	SLWD-P112	11	12	16	11.0	36.5 x 43.5
	ALWD-P130*	SLWD-P130*	13.5	10	12	9.0	37.5 x 40.0
	ALWD-P132	SLWD-P132	13.5	12	16	11.0	36.5 x 45.0
	ALWD-P137	SLWD-P137	13.5	17	20	11.0	41.0 x 50.5
	ALWD-P167	SLWD-P167	16	17	20	11.0	41.0 x 51.5
	ALWD-P213	SLWD-P213	21	23	25	12.0	52.0 x 61.0
	ALWD-P299	SLWD-P299	29	29	32	12.0	58.5 x 70.5
	ALWD-P366	SLWD-P366	36	36	40	13.0	70.0 x 85.0
	ALWD-P488	SLWD-P488	48	48	50	13.0	83.0 x 97.5

*These products will be delivered with a thread adapter

PMAJACK Plastic and metal braids

General technical details

Bundling and abrasion protection. Polyamide, polyester and steel braids – an alternative way to bundle and protect electrical cables.

Plastic braids manufactured from polyester and polyamide filaments – the other alternative solution for protecting and bundling cables.

This PMA cable protection system provides simple bundling and abrasion protection for cables and wires.

Various braid types to fulfill different requirements complimented by a range of braid terminations for simple and clean assembly.

Material

- Braids made from polyamide 6.6 or polyester
- Terminations made from PA 6, aluminium or brass
- Free from halogens, REACH + RoHS compliant

Characteristics

- Flammability of braids:
 - polyamide 6.6 UL 94 V2,
 - polyester UL 94 V0
- Braid design: Following DIN 65 164 part 1+2
- EN 45545-2 HL3





Plastic braided hoses

Type F.66 & C.66

Type F.66 - Braided hose

	Order no. black	Order no. grey	NW	Fits to termination	Weight nom. per 100 m (kg)	Operative range min. Ø (mm)	Operative range max. Ø (mm)
	F.66.04SW	F.66.04GR	4	-	0.4	3.0	7.0
	F.66.06SW	F.66.06GR	6	SRER-06	0.6	5.0	8.0
	F.66.08SW	F.66.08GR	8	SRER-06	0.8	7.0	10.0
	F.66.10SW	F.66.10GR	10	SRER-06	1.0	9.0	13.0
	F.66.12SW	F.66.12GR	12	SRER-06	1.4	11.0	16.0
	F.66.16SW	F.66.16GR	16	SRER-16	1.7	15.0	21.0
	F.66.20SW	F.66.20GR	20	SRER-16	2.0	20.0	26.0
	F.66.25SW	F.66.25GR	25	SRER-21/SRER-29	2.4	24.0	31.0
	F.66.30SW	F.66.30GR	30	SRER-21/SRER-29	3.5	28.0	38.0
	F.66.40SW	F.66.40GR	40	SRER-29	4.2	38.0	49.0
	F.66.50SW	F.66.50GR	50	SREV-40/SRER-50	5.1	48.0	65.0
	F.66.70SW	F.66.70GR	70	SREV-40/SRER-50	4.9	48.0	85.0

Approvals



Monofile Ø: 0.28mm for increased abrasion properties
 Coverage: >90%
 Polyamide 6.6
 Specifications: DIN 5510 (S4/SR2/ST2), UL-File E 125 619, EN45545-2 HL3
 Temperature range: -55°C to +135°C, short-term to +160°C

Type C.66 - Braided hose

	Order no. black	Order no. grey	NW	Fits to termination	Weight nom. per 100 m (kg)	Operative range min. Ø (mm)	Operative range max. Ø (mm)
	C.66.10SW	C.66.10GR	10	SRER-06	0.7	8.0	14.0
	C.66.12SW	C.66.12GR	12	SRER-06/SRER-16	0.9	9.0	18.0
	C.66.16SW	C.66.16GR	16	SRER-06/SRER-16	1.2	11.0	22.0
	C.66.20SW	C.66.20GR	20	SRER-16/SRER-21	1.4	14.0	26.0
	C.66.25SW	C.66.25GR	25	SRER-16/SRER-21	1.4	18.0	28.0
	C.66.30SW	C.66.30GR	30	SRER-21/SRER-29	2.5	25.0	43.0
	C.66.40SW	C.66.40GR	40	SRER-29	2.5	30.0	52.0
	C.66.45SW	-	45	SREV-40/SRER-50	4.0	40.0	73.0

Monofile Ø: 0.28mm for increased abrasion properties
 Coverage: >75%
 Polyamide 6.6
 Specifications: DIN 5510 (S4/SR2/ST2), EN45545-2 HL3
 Temperature range: -55°C to +135°C, short-term to +160°C

Plastic braided hoses

Type L.66 & F.PX

Type L.66 - Braided hose

	Order no. black	Order no. grey	NW	Fits to termination	Weight nom. per 100 m (kg)	Operative range min. Ø (mm)	Operative range max. Ø (mm)
L.66	L.66.04SW	L.66.04GR	04	–	0.4	4.0	5.0
	L.66.08SW	L.66.08GR	08	SRER-06	0.5	5.0	10.0
	L.66.10SW	L.66.10GR	10	SRER-06	0.8	7.0	13.0
	L.66.16SW	L.66.16GR	16	SRER-16	0.9	11.0	20.0
	L.66.20SW	L.66.20GR	20	SRER-16	1.4	17.0	33.0
	L.66.25SW	L.66.25GR	25	SRER-21/SRER-29	1.5	21.0	34.0
	L.66.30SW	L.66.30GR	30	SRER-21/SRER-29	1.8	25.0	45.0
	L.66.40SW	L.66.40GR	40	SRER-29	1.9	31.0	55.0
	L.66.50SW	L.66.50GR	50	SREV-40/SRER-50	3.2	58.0	70.0

Monofile Ø: 0.25mm

Coverage: > 65%

Polyamide 6.6

Specifications: DIN 5510 (S4/SR2/ST2), NF F 16-101/102 (I3/F2), EN45545-2 HL3

Temperature range: –55°C to +135°C, short-term to +160°C

Type F.PX - Braided hose

	Order no. grey	NW	Fits to termination	Weight nom. per 100 m (kg)	Operative range min. Ø (mm)	Operative range max. Ø (mm)
F.PX	F.PX.04GR	04	–	0.3	3.0	7.0
	F.PX.06GR	06	SRER-06	0.5	5.0	8.0
	F.PX.08GR	08	SRER-06	0.7	7.0	10.0
	F.PX.10GR	10	SRER-06	0.8	9.0	13.0
	F.PX.12GR	12	SRER-06	1.1	11.0	16.0
	F.PX.16GR	16	SRER-16	1.3	15.0	21.0
	F.PX.20GR	20	SRER-16/SRER-21	1.5	20.0	26.0
	F.PX.25GR	25	SRER-16/SRER-21	2.0	24.0	31.0
	F.PX.30GR	30	SRER-21/SRER-29	2.9	28.0	38.0
	F.PX.40GR	40	SREV-40	3.1	38.0	49.0

Monofile Ø: 0.28mm for increased abrasion properties

Coverage: > 90%

Polyester

Specifications: DIN 5510 (S4/SR2/ST2), NF F 16-101/102 (I3/F2), EN45545-2 HL3

Temperature range: –50°C to +120°C, short-term to +150°C

Plastic braided hoses

Type L.PX & G.PX

Type L.PX - Braided hose

	Order no. black	Order no. grey	NW	Fits to termination	Weight nom. per 100m (kg)	Operative range min. Ø (mm)	Operative range max. Ø (mm)
L.PX	L.PX.04SW	L.PX.04GR	04	-	0.4	3.0	8.0
	L.PX.08SW	L.PX.08GR	08	SRER-06	0.5	5.0	10.0
	L.PX.10SW	L.PX.10GR	10	SRER-06	0.7	7.0	14.0
	L.PX.16SW	L.PX.16GR	16	SRER-16	0.8	11.0	20.0
	L.PX.20SW	L.PX.20GR	20	SRER-16	1.2	19.0	28.0
	L.PX.25SW	L.PX.25GR	25	SRER-21/SRER-29	1.4	21.0	34.0
	L.PX.30SW	L.PX.30GR	30	SRER-21/SRER-29	1.7	25.0	40.0
	L.PX.40SW	L.PX.40GR	40	SRER-29	1.7	31.0	55.0
	L.PX.50SW	L.PX.50GR	50	SREV-40/SRER-50	2.7	40.0	68.0

Monofile Ø: 0.22mm

Coverage: > 65%

Polyester

Specifications: DIN 5510 (S4/SR2/ST2), NF F 16-101/102 (I1/F2), EN45545-2 HL3

Temperature range: -50°C to +120°C, short-term to +150°C

Type G.PX - Braided hose

	Order no. black	NW	Packing unit PU/m	Weight nom. per 100m (kg)	Recommended range	
					min. Ø (mm)	max. Ø (mm)
G.PX	G.PX.05SW	05	25	1.6	4.5	5.5
	G.PX.08SW	08	25	2.0	7.0	9.0
	G.PX.10SW	10	25	2.3	9.0	11.0
	G.PX.13SW	13	25	2.5	11.5	13.0
	G.PX.16SW	16	25	3.4	14.5	17.5
	G.PX.19SW	19	25	3.8	17.0	21.0
	G.PX.25SW	25	25	4.8	22.5	27.5
	G.PX.29SW	29	25	5.3	26.0	32.0
	G.PX.32SW	32	25	6.1	29.0	35.0
	G.PX.38SW	38	25	8.3	34.0	42.0
	G.PX.50SW	50	25	8.7	45.0	55.0

Open, self winding construction

For retrofit installation

Overlapping: 90° (+40°/-25°)

Polyester

Specifications: DIN 5510 (S4/SR2/ST2), NF F 16-101/102 (I3/F2), EN45545-2 HL3

Temperature range: -55°C to +150°C

Braid terminations, connectors

Type RER/REV

Type RER/REV - Braid termination

	Order no. grey	NW	AI (mm)	AA (mm)	BI (mm)	BA (mm)	H (mm)	L (mm)	G (mm)	S (mm)	C (mm)
	SRER-06 (x)	06	6.5	13	-	-	13	21	33	13	6
	SRER-16 (x)	16	16	24	-	-	15	25	39	15	7
	SRER-21 (x)	21	22	32	-	-	20	29	43	15	7
	SRER-29 (z)	29	30	40	-	-	18	29	43	39	7
	SRER-50 (z)	50	50	61	-	-	18	29	43	50	7
	SREV-40 (y)	40	47	58	34	44	20	24	44	38	10

For termination and fixation of plastic braided hoses

Suitable for: F.66, C.66, L.66, F.PX, L.PX braids

Polyamide 6

For exact braid and termination fitting configuration please refer to PMAJACK data sheets

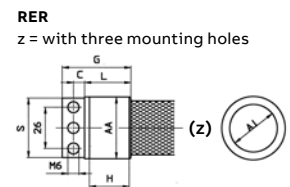
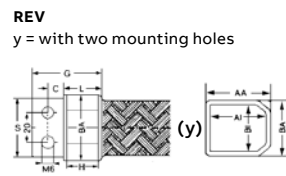
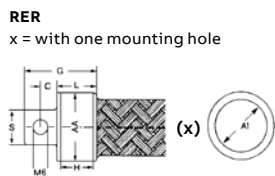

Braid terminations, connectors

Type BREIR & MREIR



Type BREIR - Connector for plastic braids, female thread

Order no. black	NW	Thread size UNEF	Fits to PMAJACK			Ø ID (mm)	Ø D1 (mm)	B (mm)	G (mm)	g (mm)	H (mm)	Ø D2 (mm)
			F.66	C.66 F.PX	L.66 L.PX							
BREIR-U2916	16	1 3/16-18	12-20	12-25	16-25	36.2	20.5	10.5	36.5	9	15	25
BREIR-U3516	16	1 7/16-18	12-20	12-25	16-25	42.5	20.5	11.5	37.5	9	15	25

For round connectors
 Suitable for: F.66, C.66, L.66, F.PX, L.PX braids
 Polyamide 6

BREIR

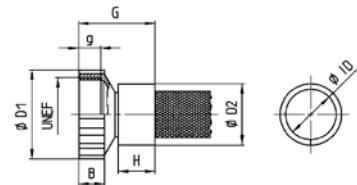

Type MREIR - Connector for plastic braids, female thread

Order no. grey	NW	Thread size UNEF	Fits to PMAJACK			g (mm)	Ø D1 (mm)	Ø D2 (mm)	L (mm)	Ø ID (mm)
			F.66	C.66	F.PX					
MREIR-U3529	29	1 7/16-18	25-40	30+40	25-40	29	40.0	40.5	37.5	30.0

For round connectors
 Suitable for: F.66, C.66, L.66, F.PX, L.PX braids
 Black anodized aluminium

MREIR

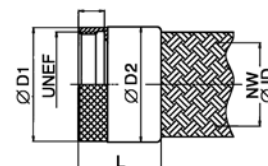

Stainless steel braids, tools

Type F.304, PMA-Tie-tool & HSG

Type F.304 - Stainless steel braided hose

	Order no.	Braid specification	Fits to conduit size NW	Operative range min. Ø (mm)	Operative range max. Ø (mm)
	F.304.10	24 x 7 x 0.3	10	10.0	18.0
	F.304.12	24 x 8 x 0.3	12	10.0	24.0
	F.304.17	24 x 12 x 0.3	17	15.0	28.0
	F.304.23	36 x 9 x 0.3	23	21.0	34.0
	F.304.29	36 x 11 x 0.3	29	25.0	40.0
	F.304.36	36 x 9 x 0.4	36	32.0	47.0
	F.304.48	48 x 10 x 0.4	48	55.0	80.0

Surface coverage: >90%

Temperature range: -70°C to +1000°C

Type PMA-Tie-tool - Clamping tool for metal cable ties

	Order no.	For PMA-Tie-tool width (mm)
PMA-Tie-tool	PMA-Tie-tool	6.35



Handtool, self locking for speedy application
 Allows easy strapping of metal cable ties "Band-It"
 For long lasting fixation without deformation
 Stainless steel
 Colour: Black

Type HSG - Hot cutting tool

	Order no.	Order no. Spare cutting tape
HSG	HSG-00	HSG-00-SB



For quick and easy cutting of plastic braidings
 Smallest hot cutting tool for permanent use
 With fixed edge (working area 30mm)
 Voltage: 230 V-50 Hz (115 V-60 Hz)
 Performance: 40W
 Length of the connecting lead: 2m

Connectors, adapters

Type VEMD

Type VEMD - Connector for overbraided conduit, metric/PG metal thread

	Order no. with jubilee clip	Thread metric	Fits to conduit size		Outside Ø x Length (mm)
			NW	Metric	
	MVEMD-M406/01	40 x 1.5	36	40	55.0 x 59.0
	MVEMD-M508/01	40 x 1.5	48	50	65.0 x 62.0
	MVEMD-M6356/01	63 x 1.5	56	68	80.0 x 72.0

	Order no. with jubilee clip	Thread PG	Fits to conduit size		Outside Ø x Length (mm)
			NW	Metric	
	MVEMD-P4856/01	48	56	68	80.0 x 72.0

Nickel-plated aluminium
IP66 up to IP68 on request

VEMD with metal cable tie "Band-It"

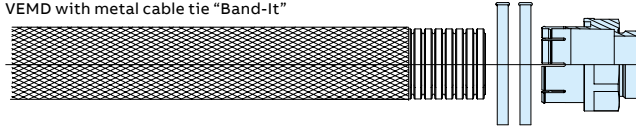

VEMD with jubilee clip

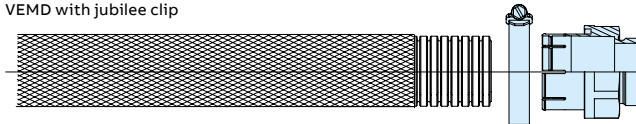

Content of delivery includes blue marked products.

Connectors, adapters

Type VEMD-RER

Type VEMD-RER - Adapter for overbraided conduit

	Order no. with Band-It *	Order no. with jubilee clip	Fits to conduit size		Width x Height x Length (mm)
			NW	Metric	
VEMD-RER	MVEMD-RER6	MVEMD-RER6/01	36	40	54.0 x 54.0 x 53.0
	MVEMD-RER8	-	48	50	66.0 x 66.0 x 53.0



*Metal cable tie
Nickel-plated aluminium
IP66 on conduit side

VEMD-RER with metal cable tie "Band-It"

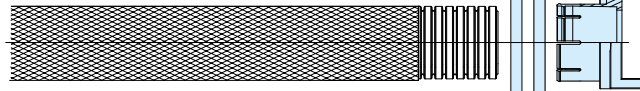

VEMD-RER with jubilee clip



Content of delivery includes
blue marked products.

Technical annex

Introduction

Conforms with standards. Intensive research and testing is the reason PMA continues to set new standards and trends in cable protection.

PMA products conform to worldwide standards and regulations.

As a pioneer in the field of cable protection, we have always given high priority to our own testing facilities, and we have consciously introduced stringent in-house standards. This approach has enabled PMA to exercise a significant influence on the development of international standards. Standards committees with responsibility for cable systems regularly ask our company to provide advice or participate as an active member.

High quality product from A–Z

From basic items to high-tech products, all of our products meet the most stringent quality requirements.

Some of the outstanding are:

- Resistance to temperature, weathering, UV radiation and chemical agents
- High system pull-out resistance
- Excellent fire protection characteristics (flammability, smoke density and toxicity)
- Excellent system ingress protection up to IP68 and IP69
- Extremely long service life
- Conformance to all major international product standards

Technical annex

Testing methods IEC EN 61386

PMA DO is a PMA in-house test.

PMA DO 9.21-4425 IEC EN 61386

Reversed bending test with swinging movements
This standard is based on a cyclic reversed bending test (pivoting) of conduit under various conditions (temperature). The conduit are dynamically loaded and evaluated at the upper and lower application temperature limits. The test is performed based on IEC EN 61386. The minimum requirement corresponds to the specifications of IEC EN 61386. For PMA, the test is not considered completed for final evaluation until cracking or fracture. The number of cycles to fracture determines the fatigue strength of the conduit.

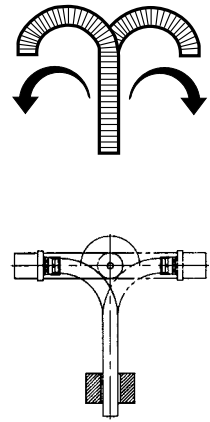

PMA DO 9.21-4420

Reversed bending test
This standard describes a cyclic reversed bending test with additional tensile loading (lifting) on flexible conduit under standard ambient conditions (23°C/50% relative humidity). The conduit is loaded until fracture. The number of cycles to fracture determines the fatigue strength of the conduit.

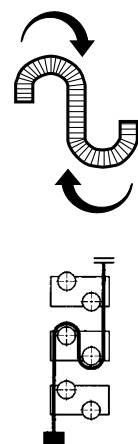

Technical annex

Testing methods IEC EN 61386

PMA DO is a PMA in-house test.

PMA DO 9.21-4320
IEC EN 61386

Peak load test

This standard describes the peak load test on conduit under standard ambient conditions (23°C/50% relative humidity). The conduit is deformed by a defined amount between two plates. The restoring force established over a specific time (by relaxation of the conduit) describes the crushing pressure or compressive strength.

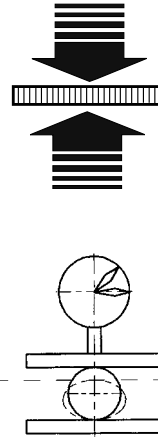

PMA DO 9.21-4610
IEC EN 61386

Pull out test

This standard defines the system pull-out test on conduit and connectors under standard ambient conditions (23°C/50% relative humidity). The conduit are mounted with the appropriate system connectors. The pull-out strength of the system is determined in a tensile test.

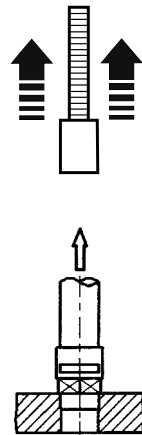

PMA DO 9.21-4330
IEC EN 61386

Impact test

This standard describes the impact strength test on conduit at various temperatures. The specimen is placed on a steel plate, centred under an impact head with a defined profile. The impact head impacts the centre of the specimen surface. In contrast to international specifications, deformation behaviour (buckling) is determining rather than fracture behaviour. The impact test is considered to be passed if no fracture or cracking can be detected after the impact, as well as no excessive permanent deformation of the conduit in accordance with PMA specifications.

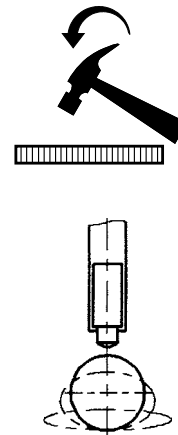

Technical annex

Testing methods IEC EN 61386

PMA DO is a PMA in-house test.

PMA DO 9.21-4380

Cold bending test

This standard describes a bending test on conduit at low temperatures. The specimens are stored in a controlled-climate cabinet at the specified test temperature. Loading is achieved by winding the specimen around a test mandrel with a defined diameter. The various products are classified based on the mandrel diameter which can be achieved.

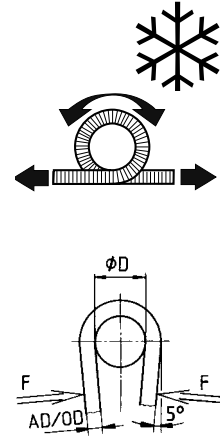

PMA DO 9.21-4360

Thermal ageing test

This standard describes a bending test on thermally aged specimens. The test conduit are stored in a controlled-climate oven at the specified test temperature. After removal from the oven, they are cooled to room temperature. Loading is achieved by winding the specimen around a test mandrel with a defined diameter. The various products are classified based on the mandrel diameter which can be achieved.

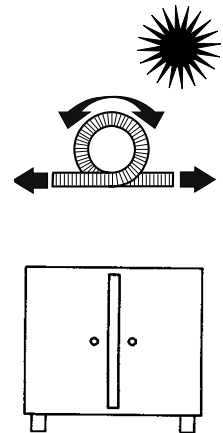

PMA DO 9.21-4430

IEC EN 61386

Self-extinguishing

This standard describes a flame test on conduit based on international specifications. The conduit is exposed to a defined flame from a standard burner. The time of ignition, flame propagation behaviour as well as time of extinguishing after removal of the flame source are significant parameters for evaluating the flame behaviour of the products.

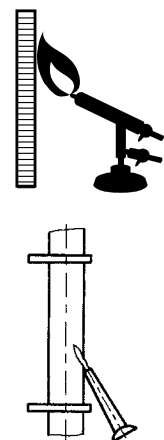

Technical annex

Ingress protections IEC 60529

Ingress protection (IP) according to IEC 60529

Ingress protection (IP)







A standard to classify product performance regarding ingress protection.

Different number – different protection!

For example, products classified as IPx8 are not automatically protected against jet water! Immersion tests for classifications IPx7 and IPx8 differ from the tests for protection against jet water for IPx6, IPx5, or IPx4.

Therefore PMA cable protection systems are tested regarding different sealing requirements.

PMA Products

			PMAFIX Pro	PMAFIX IP68 + WPS	PMAFIX IP68/ IP68GT	PMAFIX IP66	PMA Smart Line
	IPx4	Splash water from all directions	●	●	●	●	●
	IPx5	Jet water at any angle	●	●	●	●	●
	IPx6	Powerful jet water from any angle	●	●	●	●	●
	IPx7	Submersion (1m, 30 min.)	●	●	●	-	-
	IPx8	Submersion at time and pressure >IPx7	●	●	●	-	-
	IPx9	High pressure (up to 100 bar, 80°C) water from any angle	●	●*	●*	●*	●*

*IEC 60529 can be fulfilled without WPS (Water impact protection ring). PMA recommends the use of the WPS ring for trouble free practical applications



PMA products offer complete protection!









Tested to 100 bar

Technical annex

Ingress protections IEC 60529











Dust

Protection against contact and penetration of foreign objects
Degree of protection (contact/foreign bodies)

	0	No protection
	1	Objects greater than 50mm Ø, accidental touch by hands
	2	Objects greater than 12.5mm Ø, accidental touch by fingers
	3	Objects greater than 2.5mm Ø, e.g. tools/wires
	4	Objects greater than 1mm Ø, e.g. tools/wires
	5	Protected against dust - limited ingress (no harmful deposits)
	6	Totally protected against dust (dust-tight)

Water

Protection against fluids
Degree of protection (water)

	0	No protection
	1	Protected against vertically falling drops of water
	2	Protected against direct sprays of water 15° from vertical
	3	Protected against sprays of water to 60° from vertical
	4	Protected against water sprayed from all directions - limited ingress permitted
	5	Protected against low pressure jets of water from all directions - limited ingress permitted
	6	Protected against strong pressure jets of water, heavy seas - limited ingress permitted
	7	Protection against the effects of immersion between 15cm - 1m
	8	Protection against long periods of immersion under a quoted pressure, e.g. 2 bar at 24 hours
	9	IP69 Automotive standard DIN40050 and signifies resistance to high pressure jets of water (up to 80 bar) from any angle

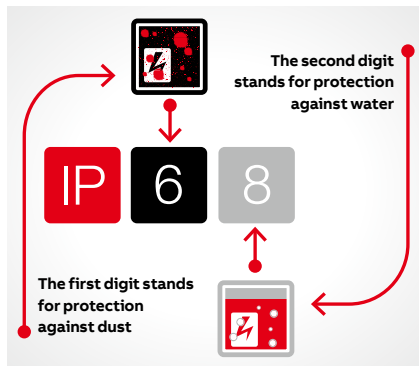

Technical annex

Table of thread dimensions

Metric fine thread - EN 60423

Metric	Pitch (mm)	Ø D1 (mm)	Ø D2 (mm)	Hole -0/+0.3 (mm)
12	1.5	12	10.16	12.0
16	1.5	16	14.16	16.0
20	1.5	20	18.16	20.0
25	1.5	25	23.16	25.0
32	1.5	32	30.16	32.0
40	1.5	40	38.16	40.0
50	1.5	50	48.16	50.0
63	1.5	63	61.16	63.0

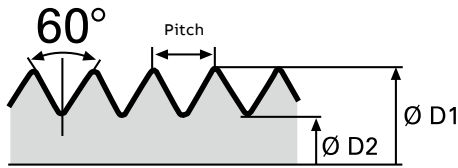

PG thread - DIN 40430

PG	Pitch (mm)	Ø D1 (mm)	Ø D2 (mm)	Hole (mm)
07	1.270	12.5	11.28	12.7
09	1.411	15.2	13.86	15.4
11	1.411	18.6	17.26	18.8
13	1.411	20.4	19.06	20.7
16	1.411	22.5	21.16	22.8
21	1.588	28.3	26.78	28.6
29	1.588	37.0	35.48	37.4
36	1.588	47.0	45.48	47.5
48	1.588	59.3	57.78	59.8

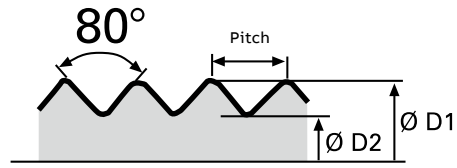

GAS pipe thread - DIN 259 Bl. 3, ISO 228/1

GAS	Pitch (mm)	Ø D1 (mm)	Ø D2 (mm)	Hole (mm)
¼"	1.337	13.157	11.445	13.4
⅜"	1.337	16.662	14.950	17.0
½"	1.814	20.955	18.631	21.3
¾"	1.814	26.441	24.117	26.8
1"	2.309	33.249	30.291	33.7
1¼"	2.309	41.910	38.952	42.4
1½"	2.309	47.803	44.845	48.3
2"	2.309	59.614	56.656	60.2

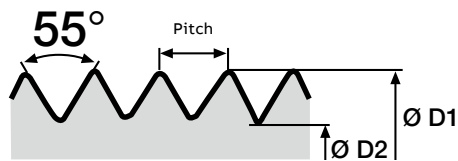

American standard taper pipe thread - ANSI/ASME B 1.20

NPT	Pitch (mm)	Ø D1 (mm)	Hole D2 (mm)
¼"	1.411	13.716	13.9
⅜"	1.411	17.145	17.4
½"	1.814	21.336	21.6
¾"	1.814	26.670	26.9
1"	2.209	33.401	33.7
1¼"	2.209	42.164	42.4
1½"	2.209	48.260	48.5
2"	2.209	60.325	60.6

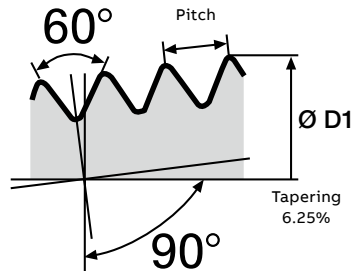

Technical annex

Comparison table

Conduit

Nominal width NW		
Standard	Metric	Inside Ø nom. (mm)
07	10	6.2
10	12	9.6
10	12	9.6
12	16	12.0
12	16	12.0
17	20	16.2
17	20	16.2
23	25	22.6
23	25	22.6
29	32	29.0
29	32	29.0
36	40	36.5
36	40	36.5
48	50	47.5
48	50	47.5

Conduit

Nominal width NW		
Standard	Metric	Inside Ø nom. (mm)
07	10	6.2
10	12	9.6
12	16	12.0
-	-	-
17	20	16.2
23	25	22.6
29	32	29.0
36	40	36.5
-	-	-
48	50	47.5

Connector metric

Inside diameter mm (nom.) ID		
Thread size	Metal thread	Polyamide thread
M12	-	8.0
M12	5.7	8.0
M16	9.6	11.0
M16	9.7	11.0
M20	13.5	13.0
M20	13.5	14.6
M25	18.3	19.0
M25	18.4	19.0
M32	24.2	24.0
M32	25.4	26.0
M40	31.4	32.0
M40	32.6	32.0
M50	39.5	39.0
M50	41.5	42.0
M63	51.4	53.0

Connector PG

Inside diameter mm (nom.) ID		
Thread size	Metal thread	Polyamide thread
PG07	-	8.0
PG09	9.5	10.0
PG11	12.5	13.0
PG13.5	14.5	14.5
PG16	16.5	17.5
PG21	22.0	22.5
PG29	30.0	30.5
PG36	40.0	37.5
PG42	-	46.0
PG48	49.5	50.0

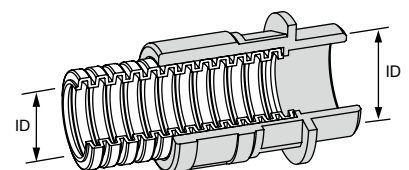

Inside diameter threads to inside diameter conduit.

Technical annex

Torques

Recommended torques for PMA fittings - For threaded bore holes and with lock nuts

Thread	Metal* [Nm]	Polyamide** [Nm]
M12	4.0	1.5
M16	4.0	3.0
M20	6.0	4.0
M25	8.0	6.0
M32	10.0	8.0
M40	15.0	9.0
M50	15.0	10.0
M63	15.0	10.0

* Thread combination: Metal + metal

** Thread combination: Metal + polyamide or polyamide + polyamide

Thread	Metal* [Nm]	Polyamide [Nm]
PG07	3.5	1.5
PG09	4.0	1.5
PG11	6.0	2.0
PG13.5	6.0	2.5
PG16	7.0	4.0
PG21	8.0	5.0
PG29	10.0	9.0
PG36	15.0	15.0
PG48	15.0	15.0

Strain relief fittings - According to EN 50262

Thread	Metal NVNZ-Mxxxx NKNZ-Mxxxx [Nm] EN	Metal NVNZ-Mxxxx/P NKNZ-Mxxxx/P [Nm]	Polyamide S/BVNZ-Mxxxx [Nm] EN
M12	5.0	6.0	0.9
M16	5.0	8.0	3.0
M20	7.5	10.0	4.0
M25	10.0	10.0	7.5
M32	15.0	15.0	10.0
M40	20.0	20.0	10.0
M50	20.0	20.0	10.0
M63	20.0	20.0	10.0

Note: These values were gauged at standard climate (23°C/50% relative humidity)

According to DIN VDE 0619

Thread	Metal NVNZ-Pxxxx [Nm]	Metal NVNZ-Pxxxx/P [Nm]	Polyamide S/BVNZ-Pxxxx [Nm]
PG07	6.25	6.0	2.5
PG09	6.25	8.0	3.75
PG11	6.25	10.0	3.75
PG13.5	6.25	10.0	3.75
PG16	7.5	10.0	5.0
PG21	10.0	15.0	7.5
PG29	10.0	20.0	7.5
PG36	10.0	30.0	7.5
PG48	10.0	40.0	7.5

Technical annex

Applications engineering information

Fill factor, relevant guidelines

The question of conduit capacity or fill factor arises in the use of cable protection systems. This describes the extent to which a conduit can or should be filled with cables and/or conductors based on the available cross-sectional area.

In all cases, PMA recommends that a conduit **capacity of 70%** not be exceeded. (Application-specific procedures and standards must also be considered.)

This ensures that operation is not unnecessarily impaired by increased friction between the individual conductors in dynamically moving systems. In addition, subsequent installation of additional conductors and/or cables is also possible if necessary.

Wiring installation: fixation

PMA AG recommends that cable protection systems be fastened with a spacing of **300mm to 500mm** between supports. This spacing can be varied depending on the application and location. This recommendation applies for all available dimensions. For larger diameters, the increased load due to the cables and conductors in the conduit is accounted for by adherence to the support spacing. PMA supplies suitable system supports for various strength requirements and applications.

European standard **EN 50343:2003-5.15** "Railway applications – Rolling stock – Rules for installation of cabling" specifies the following spacing between supports for fastening conductors:

Horizontal wiring: 300mm

Vertical wiring: 500mm

(Application specific guidelines and standards should also be considered.)

Fill factor max. 70%

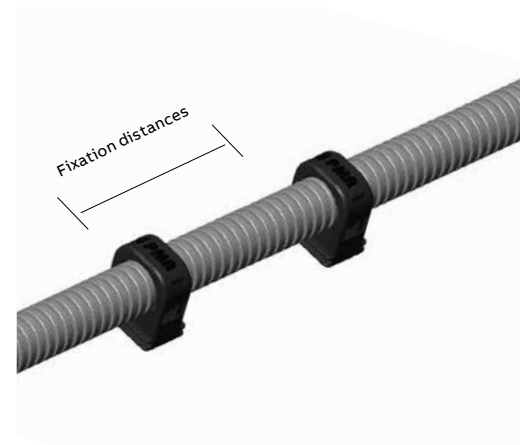
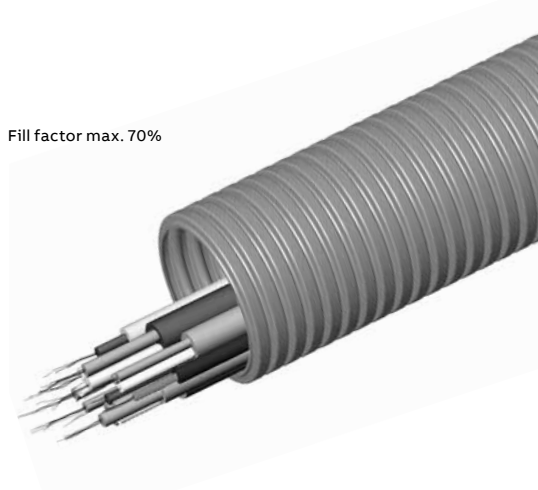

Technical annex

Chemical resistance

Chemical resistance comparison table

Resistance against	Chemical formula	PA6, Polyamide 6 PA6.6, Polyamide 6.6	PA12, Polyamide 12 PA11, Polyamide 11	PP, Polypropylene PE, Polyethylene	TPU	PFA PVDF
Acetic acid (10%)	C2H4O2	1	2	3	0	3
Acetone	C3H6O	3	3	3	0	3
Ammonia (30%)	NH3	3	3	3	0	3
Benzene	–	3	3	2	1	3
Brake fluid	–	3	3	3	0	3
Caustic soda	NaOH	3	3	3	1	3
Ethyl alcohol (40%)	C2H6O	3	3	3	1	3
Glycol	C2H6O2	3	3	3	0	3
Hydrochloric acid (10%)	HCL	0	1	3	0	3
Methanol	CH4O	2	3	3	1	3
Methyl ethyl ketone	C4H8O	3	3	3	0	3
Nitric acid (10%)	HNO3	0	0	2	0	3
Ozone	O3	2	2	2	1	3
Paint thinner	–	3	3	1	0	3
Perchloroethylene	C2Cl4	2	2	2	0	3
Paraffin	–	3	3	1	0	3
Phosphoric acid (10%)	H3O4P	1	2	3	0	3
Sea water	–	3	3	3	2	3
Soap solution	–	3	3	3	2	3
Sodium chloride	NaCl	3	3	3	3	3
Sulphuric acid (10%)	H2SO4	1	2	3	0	3
Toluene	C7H8	3	3	1	0	3
Trichloroethylene	C2HCl3	1	2	0	0	3
Turpentine	–	3	3	0	0	3
Urine	–	3	3	3	3	3

Resistance against oils and greases	Chemical formula	PA6, Polyamide 6 PA6.6, Polyamide 6.6	PA12, Polyamide 12 PA11, Polyamide 11	PP, Polypropylene PE, Polyethylene	TPU	PFA PVDF
Cutting oils*	–	3	3	2	1	3
Diesel oil	–	3	3	2	2	3
ASTM Oil Nr. 3	–	3	3	2	1	3
Fuel oil	–	3	3	2	1	3
Hydraulic oils*	–	3	3	2	1	3
Mineral oils	–	3	3	2	3	3
Spark-erosion liquids	–	3	3	2	1	3
Skydrol	–	1	2	2	0	3
Transformer oils*	–	3	3	2	1	3

*Synthetic additives can affect the oil resistance of plastics. Please contact PMA for further information

Key:

3 = Excellent resistance/suitable for permanent contact
 2 = Resistant/suitable for occasional contact
 1 = Relatively resistant/suitable for short-term contact
 0 = Not recommended

Important

The chemical resistance of plastic products is also dependant on factors such as temperature, amount of time exposed to chemicals (e.g. occasional contact or immersed) as well as the concentration of the specific chemicals. The stated chemical resistances are valid for a temperature of 20°C. The chemical resistance table above serves only as a guide for the use of polyamide products in conjunction with the listed chemicals. Each specific application should be controlled for suitability by the end-user.

Further information

Visit our website

Visit the PMA product web pages on pma.ch for our most up-to-date product lineup, and much more. This is the place to go to find all of the planning documents you need at your fingertips, including:

- Technical data sheets
- General technical details
- CAD files
- Brochures
- Videos

