



CHOICE SERIES E-LUME

QUICK SHIP



Choice Series

5 LED LAMP

T8, High Bay Retrofit, PAR20, PAR30SN, PAR30LN, PAR38, GU10, MR16, MR16E26, A19

8 LED DOWNLIGHT

LPDL™, Swivel

12 LED PANEL

14 LED MINI FLOOD

E-Lume™

19 RECESSED FIXTURE

22 INCANDESCENT LAMP

BR30, G16.5, G25, R16, R20

23 COMPACT FLUORESCENT LAMP

PAR20, T2 Spirals, 2-pin Double Twin Tube, 4-pin Double Twin Tube

24 HID LAMP

Pulse Start

25 FLUORESCENT LAMP

T8 Preheat Start, T8 800 Sries, T5 Preheat Start, T5 Program Start, T5 HO Program Start



Choice Series

Standard is proud to introduce its Choice line of LED lamps, focusing on efficiency and value. You will always find the right Choice in this line!

LED Lamp

- Ballast compatible T8 lamp offer a quick and economical solution without any additional wiring needed.
- Quality glass encasing ensures protection against tube yellowing and brittleness.
- Compatible with a variety of electronic instant start ballasts.



Order code	Description	System watts (W)			Base	Color temp. (K)	CRI	Life L70 (hrs)	Lumen output (lm)			Case qty (master)
		LBF ¹	NBF ¹	HBF ¹					LBF ¹	NBF ¹	HBF ¹	
T8 4' - Ballast Compatible												
67972	T8/S2/10.5W/835/48/CHOICE/STD	11.5	13	17	G13	3 500	80	50 000	1 600	1 800	2 400	25
67973	T8/S2/10.5W/840/48/CHOICE/STD	11.5	13	17	G13	4 000	80	50 000	1 600	1 800	2 400	25
67977	T8/S2/10.5W/850/48/CHOICE/STD	11.5	13	17	G13	5 000	80	50 000	1 600	1 800	2 400	25

Lumen values are derived from photometric testing
 For a complete list of compatible dimmers and energy start qualified products, please visit www.standardpro.com
 This lamp only operates on existing ballast in 120-277/347 V application
 1 LBF= Low ballast factor, NBF= Normal ballast factor, HBF= High ballast factor
 2 Not DLC



enclosed fixture



non dimmable



- High intensity LED lamp for high bay luminaire retrofit application.
- Simple ballast bypass installation – no need for a time consuming fixture replacement.
- Heatsink designed for optimal heat dissipation.
- Replaces a 400W HID lamp.



Order code	Description	Watts	Base	Volts	Color temp. (K)	CRI	Life L70 (hrs)	Bare lamp lumen (lm)	Operating position	Case qty (master)
		(W)		(VAC)						
67660	CRNHB/160W/40K/BYP/120-277/ND/CHOICE/STD	160	EX39	120-277	4 000	83	50 000	20 000	Vertical	4

Lumen values are derived from photometric testing
 For a complete list of compatible dimmers and DLC qualified products, please visit www.standardpro.com
¹ These products comply with UL1598C Standard for LED luminaire Retrofit kits



non dimmable



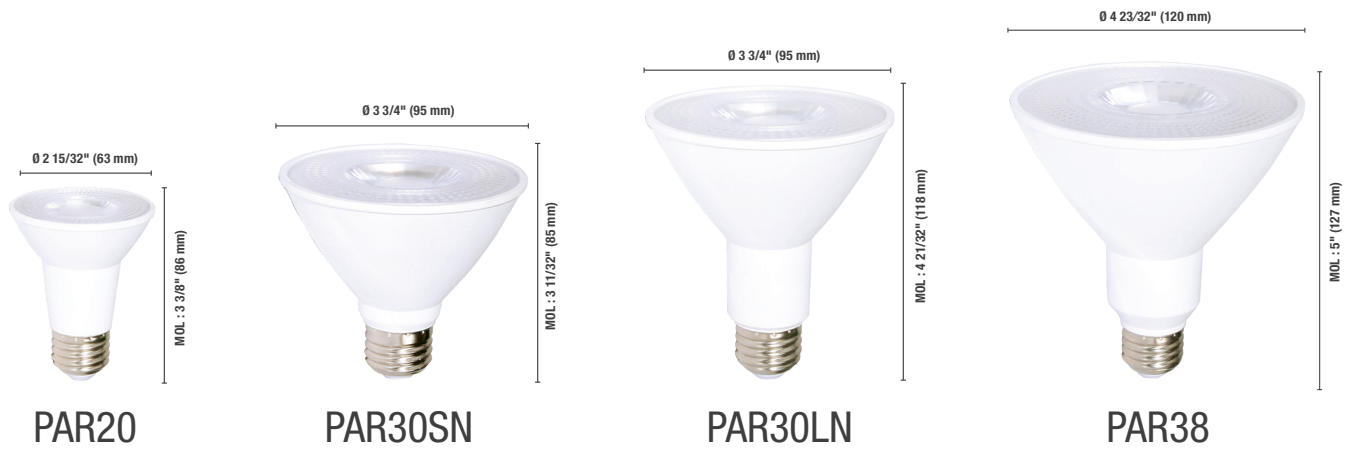

Order code	Description	Watts (W)	Base	Volts (VAC)	Color temp. (K)	CRI	Life L70 (hrs)	Lumen output (lm)	Beam angle (°)	CBCP (cd)	Traditional equivalent (W)	Case qty (master)
PAR20												
66279 ¹	P20/8W/27K/25/CHOICE/STD	8	E26	120	2 700	≥90	15 000	581	25	1 708	50	12
66280 ¹	P20/8W/27K/40/CHOICE/STD	8	E26	120	2 700	≥90	15 000	572	40	914	50	12
66281 ¹	P20/8W/30K/25/CHOICE/STD	8	E26	120	3 000	≥90	15 000	608	25	1 708	50	12
66282 ¹	P20/8W/30K/40/CHOICE/STD	8	E26	120	3 000	≥90	15 000	605	40	914	50	12
66283 ¹	P20/8W/40K/25/CHOICE/STD	8	E26	120	4 000	≥90	15 000	616	25	1 708	50	12
66284 ¹	P20/8W/40K/40/CHOICE/STD	8	E26	120	4 000	≥90	15 000	652	40	914	50	12
PAR30SN												
66291	P30S/12W/27K/25/CHOICE/STD	12	E26	120	2 700	≥90	15 000	934	25	3 843	75	6
66292	P30S/12W/27K/40/CHOICE/STD	12	E26	120	2 700	≥90	15 000	929	40	1 740	75	6
66293	P30S/12W/30K/25/CHOICE/STD	12	E26	120	3 000	≥90	15 000	965	25	3 843	75	6
66294	P30S/12W/30K/40/CHOICE/STD	12	E26	120	3 000	≥90	15 000	922	40	1 740	75	6
66295	P30S/12W/40K/25/CHOICE/STD	12	E26	120	4 000	≥90	15 000	1 006	25	3 843	75	6
66296	P30S/12W/40K/40/CHOICE/STD	12	E26	120	4 000	≥90	15 000	977	40	1 740	75	6
PAR30LN												
66285	P30L/12W/27K/25/CHOICE/STD	12	E26	120	2 700	≥90	15 000	942	25	4 178	75	6
66286	P30L/12W/27K/40/CHOICE/STD	12	E26	120	2 700	≥90	15 000	935	40	1 813	75	6
66287	P30L/12W/30K/25/CHOICE/STD	12	E26	120	3 000	≥90	15 000	974	25	4 178	75	6
66288	P30L/12W/30K/40/CHOICE/STD	12	E26	120	3 000	≥90	15 000	935	40	1 813	75	6
66289	P30L/12W/40K/25/CHOICE/STD	12	E26	120	4 000	≥90	15 000	1 024	25	4 178	75	6
66290	P30L/12W/40K/40/CHOICE/STD	12	E26	120	4 000	≥90	15 000	996	40	1 813	75	6
PAR38												
66297	P38/16.5W/27K/25/CHOICE/STD	16.5	E26	120	2 700	≥90	15 000	1 360	25	6 067	100	6
66298	P38/16.5W/27K/40/CHOICE/STD	16.5	E26	120	2 700	≥90	15 000	1 398	40	2 527	100	6
66299	P38/16.5W/30K/25/CHOICE/STD	16.5	E26	120	3 000	≥90	15 000	1 419	25	6 067	100	6
66300	P38/16.5W/30K/40/CHOICE/STD	16.5	E26	120	3 000	≥90	15 000	1 355	40	2 527	100	6
66301	P38/16.5W/40K/25/CHOICE/STD	16.5	E26	120	4 000	≥90	15 000	1 548	25	6 067	100	6
66302	P38/16.5W/40K/40/CHOICE/STD	16.5	E26	120	4 000	≥90	15 000	1 510	40	2 527	100	6

Lumen values are derived from photometric testing
 For a complete list of compatible dimmers and ENERGY STAR qualified products, please visit
www.standardpro.com





GU10



MR16



MR16
E26



A19



A19 4 pack

Order code	Description	Watts (W)	Base	Volts (VAC)	Color temp. (K)	CRI	Life L70 (hrs)	Lumen output (lm)	Beam angle (°)	CBCP (cd)	Traditional equivalent (W)	Dimming capability (Yes/No)	Case qty (inner/master)
GU10													
66304	GU10/6.5W/27K/40/CHOICE/STD	6.5	GU10	120	2 700	≥80	15 000	500	40	778	50	Yes	1/24
66306	GU10/6.5W/30K/40/CHOICE/STD	6.5	GU10	120	3 000	≥80	15 000	500	40	778	50	Yes	1/24
66308	GU10/6.5W/40K/40/CHOICE/STD	6.5	GU10	120	4 000	≥80	15 000	500	40	778	50	Yes	1/24
MR16													
68786	MR16/S2/12V/6.5W/27K/35/CHOICE/STD	6.5	GU5.3	12	2 700	≥80	25 000	500	35	1 772	50	Yes	1/24
68787	MR16/S2/12V/6.5W/30K/35/CHOICE/STD	6.5	GU5.3	12	3 000	≥80	25 000	500	35	1 772	50	Yes	1/24
68788	MR16/S2/12V/6.5W/40K/35/CHOICE/STD	6.5	GU5.3	12	4 000	≥80	25 000	500	35	1 772	50	Yes	1/24
MR16-E26													
66354	MR16E26/7W/30K/35/CHOICE/STD	7	E26	120	3 000	82	15 000	500	35	1 321	50	Yes	6/48
A19													
Energy Star & Enclosed rated													
66267	A19/6W/27K/ND/CHOICE/STD	6	E26	120	2 700	≥80	15 000	480	-	-	40	No	6/48
66268	A19/6W/30K/ND/CHOICE/STD	6	E26	120	3 000	≥80	15 000	480	-	-	40	No	6/48
68593	A19/S3/9.5W/27K/ND/CHOICE/STD	9.5	E26	120	2 700	≥80	15 000	800	-	-	60	No	6/48
66270	A19/9.5W/30K/ND/CHOICE/STD	9.5	E26	120	3 000	≥80	15 000	800	-	-	60	No	6/48
A19													
Not Energy Star, Not suitable for enclosed fixture²													
67964	A19/S2/6W/27K/ND/CHOICE/STD	6	E26	120	2 700	80	15 000	480	180	-	40	No	1/100
67965	A19/S2/6W/30K/ND/CHOICE/STD	6	E26	120	3 000	80	15 000	480	180	-	40	No	1/100
67966	A19/S2/9W/27K/ND/CHOICE/STD	9	E26	120	2 700	80	15 000	480	180	-	60	No	1/100
67967	A19/S2/9W/30K/ND/CHOICE/STD	9	E26	120	3 000	80	15 000	800	-	-	60	No	1/100
A19 4 Pack													
Energy Star & Enclosed rated													
68594	A19/S3/9.5W/27K/ND/CHOICE/STD 4P	9.5	E26	120	2 700	≥80	15 000	800	-	-	60	No	1/12
66272	A19/9.5W/30K/ND/CHOICE/STD 4P	9.5	E26	120	3 000	≥80	15 000	800	-	-	60	No	1/12
66273	A19/9.5W/40K/ND/CHOICE/STD 4P	9.5	E26	120	4 000	≥80	15 000	800	-	-	60	No	1/12
68595	A19/S3/9.5W/50K/ND/CHOICE/STD 4P	9.5	E26	120	5 000	≥80	15 000	800	-	-	60	No	1/12
A19 4 Pack													
Not Energy Star, Not suitable for enclosed fixture²													
67968	A19/S2/9W/27K/ND/CHOICE/STD 4P	9	E26	120	2 700	80	15 000	800	180	-	60	No	4/100
67969	A19/S2/9W/30K/ND/CHOICE/STD 4P	9	E26	120	3 000	80	15 000	800	180	-	60	No	4/100
67970	A19/S2/9W/40K/ND/CHOICE/STD 4P	9	E26	120	4 000	80	15 000	800	180	-	60	No	4/100
67971	A19/S2/9W/50K/ND/CHOICE/STD 4P	9	E26	120	5 000	80	15 000	800	180	-	60	No	4/100

Lumen values are derived from photometric testing
 For a complete list of compatible dimmers, and energy start qualified products, please visit www.standardpro.com
² 2 year warranty.





LED Downlight

LPDL™

The LED downlight LPDL Choice gives you all the flexibility you need during installation, especially in confined areas or when facing constraints such as wood beams, ceiling joist or air ducts.

The driver is mounted separately from the light source which allows the luminaire profile to be less than 1" thick!



Order code	Model number	Watts (W)	Volts (VAC)	Color temp. (K)	Lumen output (lm)	Efficiency (lm/W)	CRI	Life L70 (hrs)	Beam angle (°)	Cable rating	Finish	Dimming (Yes/No)	Power factor	THD (%)	Traditional equivalent (W)	Case qty (master)
4" Round Single CCT																
68304	LPDL4R-11A-30WH/CHOICE	11	120	3 000	750	68	80+	50 000	100	FT4	White	Yes	>0.9	<15	60	32
67932	LPDL4/RND/11W/30K/BN/CHOICE/STD	11	120	3 000	700	64	80+	50 000	100	FT4	Brushed Nickel	Yes	>0.9	<15	60	32
67933	LPDL4/RND/11W/40K/BN/CHOICE/STD	11	120	4 000	700	64	80+	50 000	100	FT4	Brushed Nickel	Yes	>0.9	<15	60	32
Bulk pack of 10 units single CCT																
68310	LPDL4R-11A-30WH/CHOICE 10P	11	120	3 000	750	68	80+	50 000	100	FT4	White	Yes	>0.9	<15	60	40
CCT Selectable																
68305	LPDL4R-11A-3CWH/CHOICE	11	120	2 700/3 000/4 000	750	63	80+	50 000	100	FT4	White	Yes	>0.9	<15	60	32
68308	LPDL4R-11A-3CBN/CHOICE	11	120	2 700/3 000/4 000	750	63	80+	50 000	100	FT4	Brushed Nickel	Yes	>0.9	<15	60	32
6" Round CCT Selectable																
68309	LPDL6R-14A-3CWH/CHOICE	14	120	2 700/3 000/4 000	1 100	71	80+	50 000	100	FT4	White	Yes	>0.9	<15	60	18

Typical color temperature range: +/- 5 %.

Lumen values are derived from Energy Star reported data. Initial lumens range: +/- 10 %.

Life hours are derived from IESNA LM-80-08 testing report and projected per IESNA TM-21-11 extrapolations.

Dimensions

4"

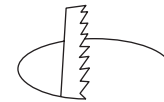
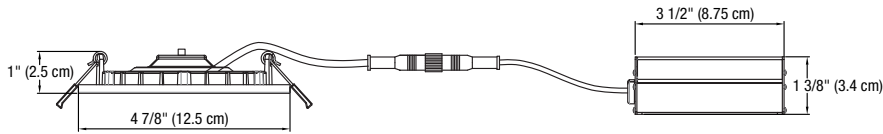

Ø 4 1/4" (108 mm)

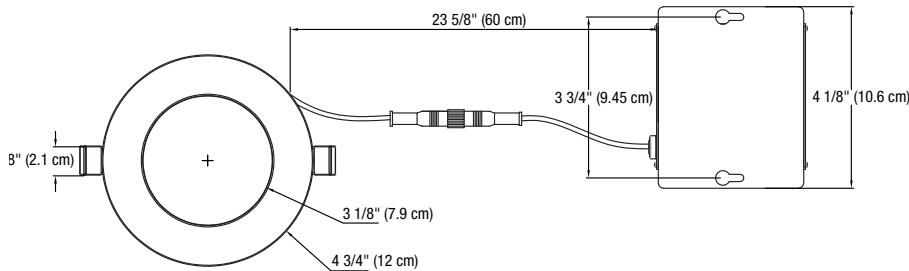

6"

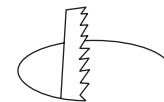
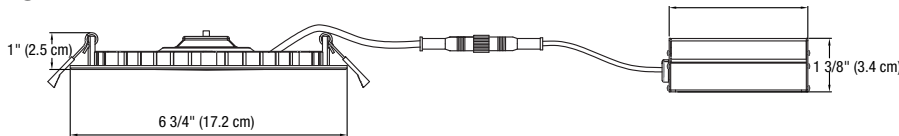

Ø 6 1/4" (159 mm)

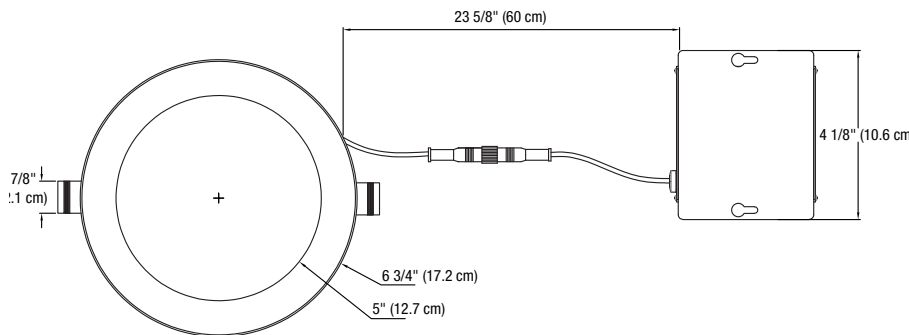

Accessories

Order code	Model number	Type	Inner diameter (in)	Outer diameter (in)	Master case qty
66821 ¹	ACC/MPLATE/4.25IN/HANG.BARS/STD	Mounting plate with hanger bars	4 1/4	-	25
66058	ACC/MPLATE/4.25/ADJ/STD	Adjustable mounting plate	4 1/4	-	24
66051	ACC/MPLATE/4.25/SQR/STD	Square mounting plate	4 1/4	-	96
66143	ACC/4/VAPOR BARRIER/STD	Vapor barrier extender	4 1/4	-	50
68986	GOOF RING-4.25IN	Goof rings	4 1/4	6 1/2	120
66822 ¹	ACC/MPLATE/6.25IN/HANG.BARS/STD	Mounting plate with hanger bars	6 1/4	-	25
64921	RF/ACC/6/MOUNT.PLATE/ADJ/STD	Adjustable mounting plate	6 1/4	-	24
64263	ACC/MPLATE/6.25IN/SQR/STD	Square mounting plate	6 1/4	-	96
66144	ACC/6/VAPOR BARRIER/STD	Vapor barrier extender	6 1/4	-	50
68987	GOOF RING-6.25IN	Goof rings	6 1/4	7 7/8	120
64264 ²	LPDL/ACC/6FT/EXTCABLE/STD	6' extension cord	-	-	96

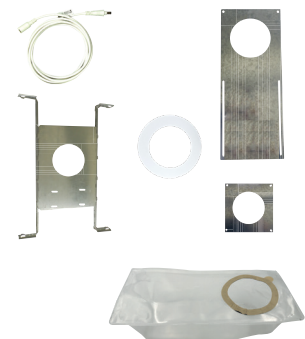

¹ Includes brackets and screws.
² Up to 6 FT4 extension cords can be connected together.

Lumen values are derived from photometric testing
 For a complete list of compatible dimmers and ENERGY STAR
 qualified products, please visit www.standardpro.com



Swivel LED Downlight



The LED SWIVEL Choice downlight has been specially designed to highlight specific zones by offering 360° rotation with a 90° tilt. Featuring great performance and quality with a CRI of 90+, this 4" directional downlight is easy to install in any type of ceiling. The LED SWIVEL Choice downlight is a cost-effective solution for all residential applications.

Order code	Model number	Watts (W)	Volts (VAC)	Color temp. (K)	Lumen output (lm)	Efficiency (lm/W)	CRI	Life L70 (hrs)	Beam angle (°)	Cable rating	Finish	Dimming (Yes/No)	Power factor	THD (%)	Case qty (master)
Single CCT															
68508	SWDL4R-9A-30WH/CHOICE	9	120	3 000	750	83	90+	50 000	45	FT4	White	Yes	>0.9	<15	32
CCT Selectable															
68671	SWDL4R-8A-3CWH/CHOICE	8	120	2 700/3 000/4 000	600	75	90+	50 000	45	FT4	White	Yes	>0.9	<15	32
68672	SWDL4R-8A-3CBK/CHOICE	8	120	2 700/3 000/4 000	600	75	90+	50 000	45	FT4	Black	Yes	>0.9	<15	32
68673	SWDL4R-8A-3CBN/CHOICE	8	120	2 700/3 000/4 000	600	75	90+	50 000	45	FT4	Brushed Nickel	Yes	>0.9	<15	32

Dimensions



Single CCT

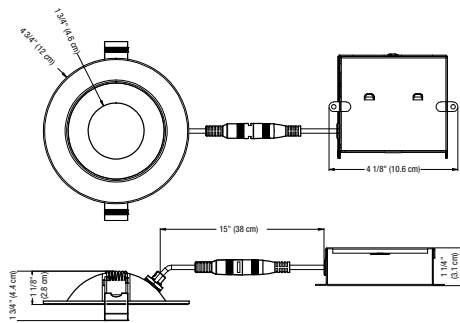

CCT Selectable

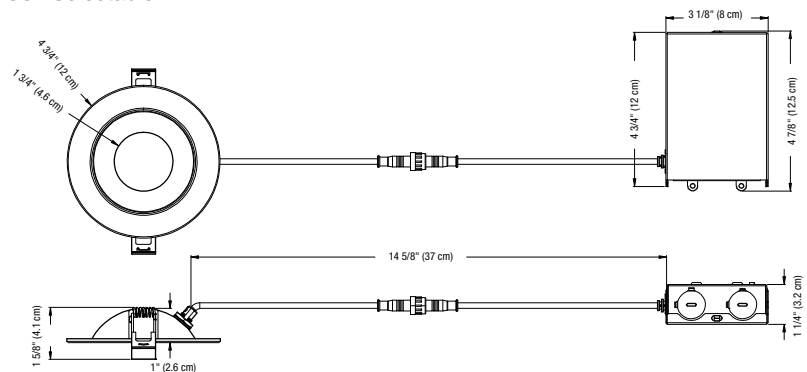

Accessories

Order code	Model number	Opening diameter (in.)	Type	Case qty (master)
66050 ¹	ACC/MPLATE/3.75IN/SQR/STD	3 3/4	Square mounting plate	96
66057 ¹	ACC/MPLATE/3.75IN/ADJ/STD	3 3/4	Adjustable mounting plate	24
64264 ²	LPDL/ACC/6FT/EXTCABLE/STD	-	6' Extension cord	96

¹ Includes brackets and screws.

² Only compatible with 68508.

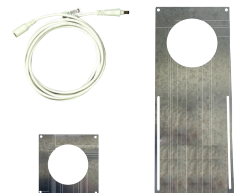

Lumen values are derived from photometric testing
For a complete list of compatible dimmers and ENERGY STAR qualified products, please visit www.standardpro.com





LED Panel

Our Choice LED Panels operate from 100 V to 277 V. The sleek and modern design is easily and quickly installed. The Choice commercial grade panels are the perfect solution to meet required light levels in any application. LED Choice Panels are perfect for offices, schools and commercial buildings.

- Consistent even dimming you can depend on. Dimmable 0-10V
- Designed to fit seamlessly into existing T-bar systems or alternatively can be surface-mounted or suspended for a unique look
- LED Choice panels are offered in a variety of color temperatures 3500 K, 4000 K and 5000 K
- Ideal replacement for traditional fluorescent fixtures, offering a uniform light and minimal glare

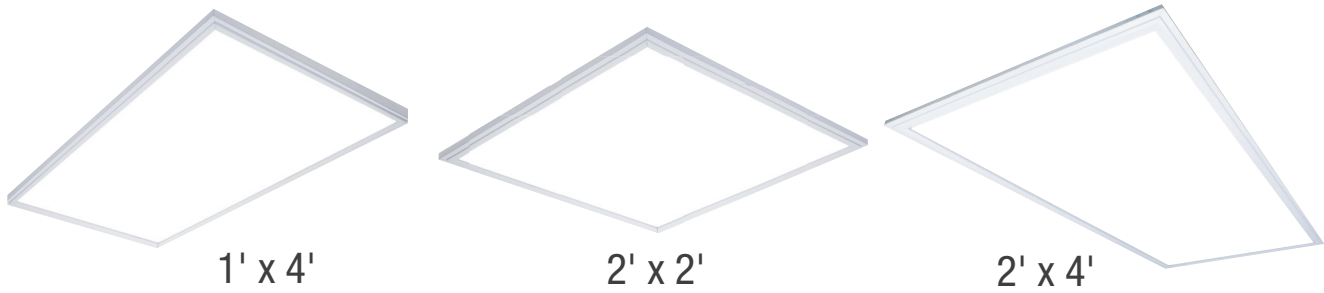

Order code	Description	Watts (W)	Volts (VAC)	Color temp. (K)	Lumen output (lm)	CRI	Life L70 (hrs)	Case qty (master)
1' x 4'								
67151	PAN1X4/100-277/40W/35K/CHOICE/STD	40	100-277	3 500	4 102	82	50 000	2
67152	PAN1X4/100-277/40W/40K/CHOICE/STD	40	100-277	4 000	4 235	82	50 000	2
2' x 2'								
67154	PAN2X2/100-277/40W/35K/CHOICE/STD	40	100-277	3 500	4 105	82	50 000	4
67155	PAN2X2/100-277/40W/40K/CHOICE/STD	40	100-277	4 000	4 178	82	50 000	4
67156	PAN2X2/100-277/40W/50K/CHOICE/STD	40	100-277	5 000	4 323	83	50 000	4
2' x 4'								
67158	PAN2X4/100-277/50W/40K/CHOICE/STD	50	100-277	4 000	5 312	83	50 000	2

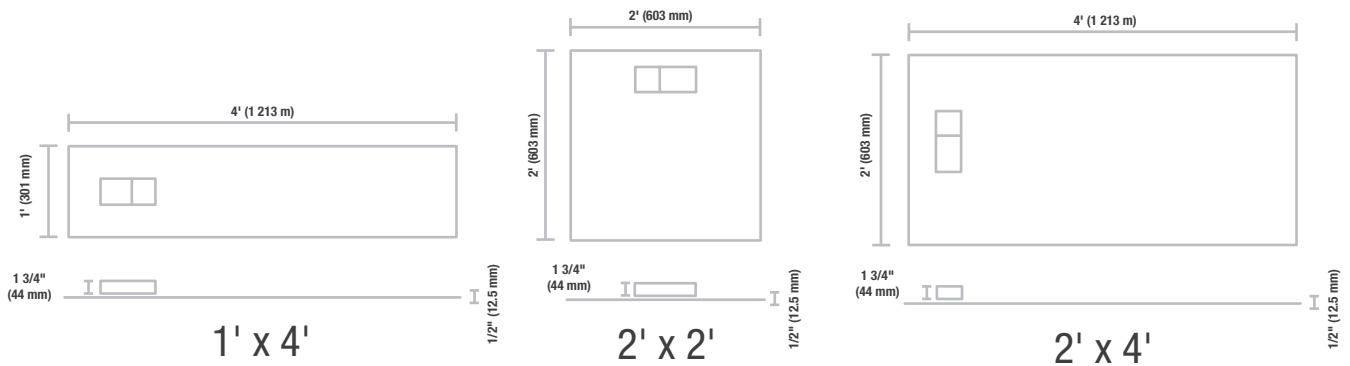

Accessories

Order code	Description	Type
64825	LPAN/ACC/2X2/SMK/STD	Surface mount kit
64826	LPAN/ACC/1X4/SMK/STD	Surface mount kit
64827	LPAN/ACC/2X4/SMK/STD	Surface mount kit
64828	LPAN/ACC/2X2/SUSPENSION/STD	Suspension cable
64829	LPAN/ACC/1X4_2X4/SUSPENSION/STD	Suspension cable
63490	DRYWALL KIT FOR 1X4 FRT/STD	Drywall kit
67164	DRYWALL KIT FOR 2X2	Drywall kit
63491	DRYWALL KIT FOR 2X4 FRT/STD	Drywall kit



Lumen values are derived from photometric testing
 For a complete list of compatible dimmers and DLC qualified products, please visit www.standardpro.com





LED Mini Flood

STANDARD's Choice LED Mini Flood Luminaires create bright, shadow-free security and ambient lighting for a variety of outdoor applications, including facades, landscapes, public places and residential complexes. They are offered in multiple wattages to fit both residential and commercial uses, and have a wide flood distribution for a large and uniform light pattern.



A



B



C



D



E



F



G



H

Order code	Description	Watts	Volts	Color temp.	CRI	Life L70	Lumen output	Finish	Figure	Traditional equivalent (W)		Case qty (master)
		(W)	(VAC)	(K)	(hrs)	(lm)	MH			HPS		

Knuckle

67300	FL/10W/30K/KN/BK/CHOICE/STD	10	120	3 000	80	50 000	1 063	Black	A	50	35	60
67223	FL/10W/40K/KN/BK/CHOICE/STD	10	120	4 000	80	50 000	1 069	Black	A	50	35	60
67301	FL/20W/30K/KN/BK/CHOICE/STD	20	120	3 000	80	50 000	1 803	Black	B	70	70	40
67302	FL/30W/30K/KN/BK/CHOICE/STD	30	120	3 000	80	50 000	3 087	Black	C	100	70	20
67229	FL/50W/40K/KN/BK/CHOICE/STD	50	120	4 000	80	50 000	5 397	Black	D	175	150	20

Yoke

67224	FL/10W/40K/YK/BK/CHOICE/STD	10	120	4 000	80	50 000	1 069	Black	E	50	35	60
67226	FL/20W/40K/YK/BK/CHOICE/STD	20	120	4 000	80	50 000	1 870	Black	F	70	70	30
67228	FL/30W/40K/YK/BK/CHOICE/STD	30	120	4 000	80	50 000	3 191	Black	G	100	70	20
67230	FL/50W/40K/YK/BK/CHOICE/STD	50	120	4 000	80	50 000	5 397	Black	H	175	150	10

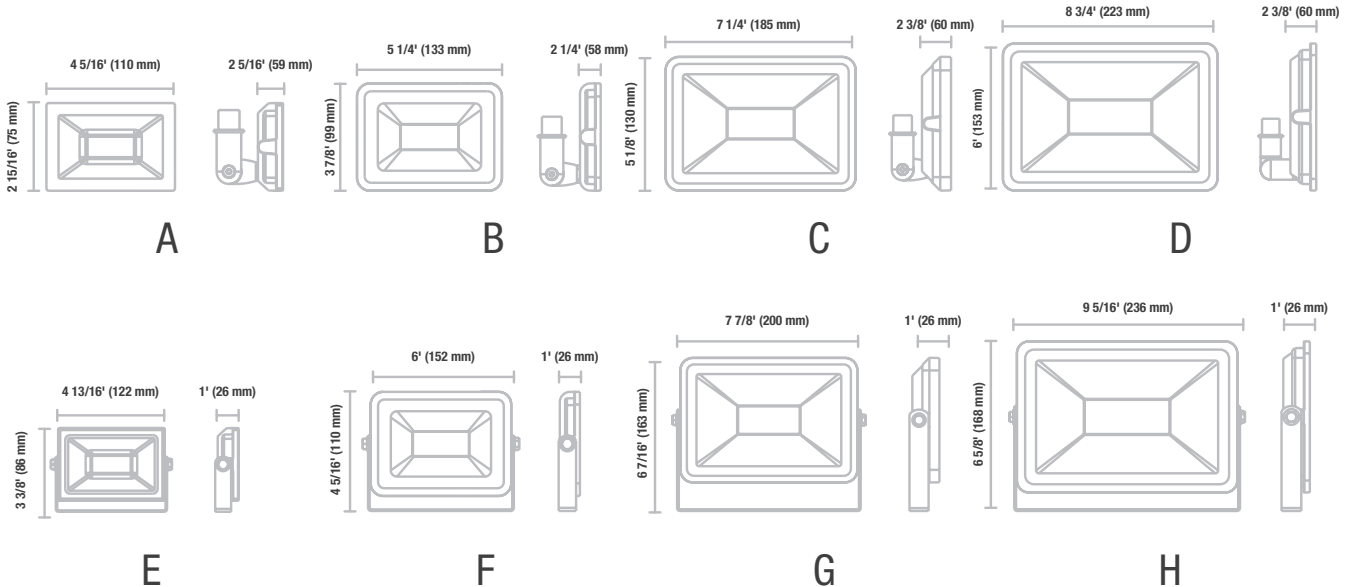

Lumen values are derived from photometric testing
 For a complete list of DLC qualified products, please visit www.standardpro.com





E-Lume™

STANDARD offers a variety of products within its E-Lume™ brand, providing a good balance between great value and excellent performance.



Recessed Fixture

The E-Lume™ Recessed Fixtures line is composed of airtight housings and of a variety of trims, offering different designs and finishes.

4 1/4" Housings



Order code	Description	Opening diameter (in.)	Volts (VAC)	Socket	Case qty (master)
Remodeler - IC Airtight					
64359 ^{2,4}	RF4in/REMOD/IC/LED/E26/ELUME	4 1/4	120	E26	6
64360 ^{1,4}	RF4in/REMOD/IC/LED/GU10/ELUME	4 1/4	120	GU10	6
New Construction - IC Airtight					
64361 ^{1,4}	RF4in/NC/IC/NOBOX/LED/GU10/ELUME	4 1/4	120	GU10	6
64362 ^{2,4}	RF4in/NC/IC/NOBOX/LED/E26/ELUME	4 1/4	120	E26	6
New Construction - IC Airtight					
64363 ³	RF4in/NC/IC/E26/ELUME	4 1/4	120	E26	6
64364 ³	RF4in/NC/IC/GU10/ELUME	4 1/4	120	GU10	6

4 1/4" Trims

Compatible Lamp (PAR20)

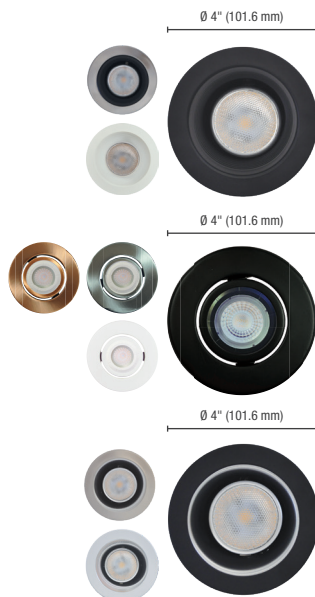

Order code	Description	Finish	Rotation angle (°)	Case qty (master)
Deep Baffle				
64376	RF4/TRIM/DB/BLK/PAR20/ELUME	Black	N/A	24
64377	RF4/TRIM/DB/BLK_BR.NKL/PAR20/ELUME	Black / Brushed Nickel	N/A	24
64378	RF4/TRIM/DB/WH/PAR20/ELUME	White	N/A	24
Gimbal				
64379	RF4/TRIM/GMB/BLK/PAR20/ELUME	Black	30	12
64381	RF4/TRIM/GMB/BR.NKL/PAR20/ELUME	Brushed Nickel	30	12
64383	RF4/TRIM/GMB/WH/PAR20/ELUME	White	30	12
64384	RF4/TRIM/GMB/BRZ/PAR20/ELUME	Bronze	30	12
Reflector				
64372	RF4/TRIM/RFL_BLK/PAR20/ELUME	Black	N/A	24
64373	RF4/TRIM/RFL_WH/PAR20/ELUME	White	N/A	24
64374	RF4/TRIM/RFL_BR.NKL/PAR20/ELUME	Brushed Nickel	N/A	24

For complete warranty information please visit www.standardpro.com
⁴ Only valid with LED lamps

1 yr ⁶
warranty damp location

airtight

7w ¹ **9w** ² **50w** ³
maximum per lamp maximum per lamp maximum per lamp **UL** US

4 1/4" Trims

Compatible Lamp (MR16 GU10, MR16 E26, PAR16)

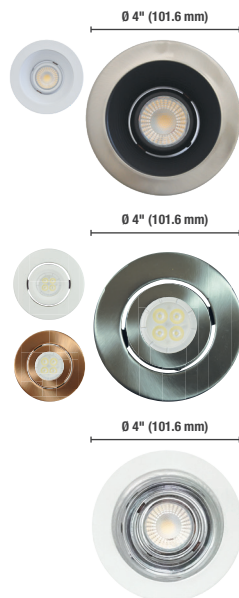

Order code	Model number	Finish	Rotation angle (°)	Case qty (master)
Deep Baffle - Gimbal				
64371	RF4/TRIM/GMB.DB/BLK_BR.NKL/MR16/ELUME	Black / Brushed Nickel	30	24
64375	RF4/TRIM/GMB.DB/WH/MR16/ELUME	White	30	24
Gimbal				
64380	RF4/TRIM/GMB/BR.NKL/MR16/ELUME	Brushed Nickel	30	12
64382	RF4/TRIM/GMB/WH/MR16/ELUME	White	30	12
64385	RF4/TRIM/GMB/BRZ/MR16/ELUME	Bronze	30	12
Reflector - Gimbal				
65548	RF4/TRIM/GMB.DB/RFL_WH/MR16/ELUME	Chrome / White	30	24
66751	F4/TRIM/GMB.DB_SLEEK/WH/MR16/ELUME	White	30	24

4 1/4" Shower Trims

Compatible Lamp² (PAR20)

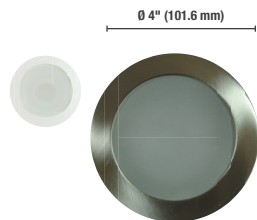

Order code	Description	Finish	Rotation angle (°)	Case qty (master)
Shower				
64387 ¹	RF4/TRIM/SWR/BR.NKL/PAR20/ELUME	Brushed Nickel	N/A	24
64389 ¹	RF4/TRIM/SWR/WH/PAR20/ELUME	White	N/A	24

4 1/4" Shower Trims

Compatible Lamp² (MR16 GU10, MR16 E26, PAR16)

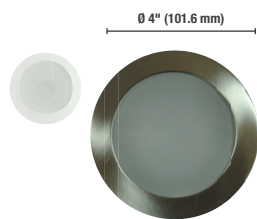

Order code	Description	Finish	Rotation angle (°)	Case qty (master)
Shower				
64386 ¹	RF4/TRIM/SWR/BR.NKL/MR16/ELUME	Brushed Nickel	N/A	24
64388 ¹	RF4/TRIM/SWR/WH/MR16/ELUME	White	N/A	24

Accessories

Order code	Description	Opening diameter (in.)	Type	Case qty (master)
66052	RF/ACC/4.5/MOUNT. PLATE/SQR/STD	4 1/2	Square mounting plate	50
62772	RF/ACC/4.5/MOUNT. PLATE/HANG.BARS/STD	4 1/2	Mounting plate with hanger bars	25
62679	ACC/VAPOR BARRIER/STD	-	Vapor barrier extender	25
66143	ACC/4/VAPOR BARRIER/STD	4 1/4	Vapor barrier extender	50

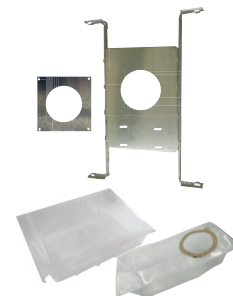

¹ Notes: Not recommended for use in steam showers or when directly exposed to water

² Enclosed fixtures may reduce the LED or CFL lamp life



Incandescent Lamp



BR30



G16.5



G25



R16



R20

Order code	Description	Watts (W)	Base	Volts (VAC)	Finish	Filament	Life L70 (hrs)	Lumen output (lm)	LCL (in.)	LCL (mm)	Case qty (inner/master)
BR30											
52452	65BR30/FL/5M/ES/130V/ELUME 2P	65	E26	130	Frost	CC-6	5 000	590	4	101	12/60
G16.5											
52453	25G16.5/CL/3M/E12/130V/ELUME 2P	25	E12	130	Clear	C-7A	3 000	160	1 7/8	48	24/120
52454	40G16.5/CL/3M/E12/130V/ELUME 2P	40	E12	130	Clear	C-7A	3 000	315	1 7/8	48	24/120
G25											
52455	40G25/CL/3M/130V/ELUME 2P	40	E26	130	Clear	C-9	3 000	350	2 7/8	73	12/60
52457	40G25/WH/3M/130V/ELUME 2P	40	E26	130	White	C-9	3 000	330	2 7/8	73	12/60
R16											
52459	40R16/SW/1M/120V/ELUME 2P	40	E26	120	Soft White	CC-6	1 000	445	3 1/32	77	12/60
52460	60R16/SW/1M/130V/ELUME 2P	60	E26	130	Soft White	CC-6	1 000	730	3 1/32	77	12/60
R20											
52462	30R20/FL/5M/130V/ELUME 2P	30	E26	130	Frost	C-9	5 000	135	2 9/16	65	12/60
61707	45R20/FL/5M/130V/ELUME 2P	45	E26	130	Frost	CC-6	5 000	242	2 9/16	65	12/60

CFL Lamp



PAR20



T2



4 pack



12 pack

Order code	Description	Watts (W)	Base	Color temp. (K)	CRI	Life L70 (hrs)	Lumen output (lm)	Traditional equivalent (W) Incandescent	Case qty (master)
PAR20									
59674	CF9/41K/PAR20/E26/ELUME	9	E26	4 100	82	8 000	300	50	6/48
T2 Spirals									
62764	CF7/T2/27K/SPIRAL/E26/ELUME	7	E26	2 700	82	10 000	430	40	6/48
61020	CF9/T2/27K/SPIRAL/E26/ELUME	9	E26	2 700	82	10 000	550	40	6/48
62311	CF9/T2/41K/SPIRAL/E26/ELUME	9	E26	4 100	82	10 000	550	40	6/48
62765	CF11/T2/27K/SPIRAL/E26/ELUME	11	E26	2 700	82	10 000	730	40	6/48
61021	CF13/T2/27K/SPIRAL/E26/ELUME	13	E26	2 700	82	10 000	900	60	6/48
61024	CF13/T2/30K/SPIRAL/E26/ELUME	13	E26	3 000	82	10 000	900	60	6/48
61026	CF13/T2/35K/SPIRAL/E26/ELUME	13	E26	3 500	82	10 000	850	60	6/48
61031	CF20/T2/27K/SPIRAL/E26/ELUME	20	E26	2 700	82	10 000	1 330	75	6/48
61032	CF23/T2/27K/SPIRAL/E26/ELUME	23	E26	2 700	82	10 000	1 600	100	6/48
61033	CF23/T2/30K/SPIRAL/E26/ELUME	23	E26	3 000	82	10 000	1 600	100	6/48
61034	CF23/T2/41K/SPIRAL/E26/ELUME	23	E26	4 100	82	10 000	1 600	100	6/48
61035	CF23/T2/50K/SPIRAL/E26/ELUME	23	E26	5 000	82	10 000	1 600	100	6/48
T2 Spirals packs									
61022	CF13/T2/27K/SPIRAL/E26/ELUME 4P	13	E26	2 700	82	10 000	900	60	1/64
61025	CF13/T2/30K/SPIRAL/E26/ELUME 4P	13	E26	3 000	82	10 000	900	60	1/64
61027	CF13/T2/41K/SPIRAL/E26/ELUME 4P	13	E26	4 100	82	10 000	880	60	1/64
61023	CF13/T2/27K/SPIRAL/E26/ELUME 12P	13	E26	2 700	82	10 000	900	60	1/48

CFL Lamp



2-pin Double Twin Tube



4-pin Double Twin Tube

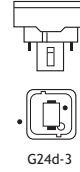

G24d-3

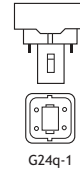

G24q-1

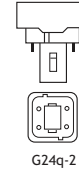

G24q-2

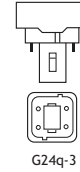

G24q-3

2-pin

4-pin

Order code	Description	Watts (W)	Base	Color temp. (K)	CRI	Life L70 (hrs)	Lumen output (lm)	MOL (in.) (mm)	Case qty (master)
2-pin Double Twin Tube									
14113	PL26/27K/DTT/2P/ELUME	26	G24d-3	2 700	82	10 000	1 540	6 ¹³ / ₁₆	6/96
14114	PL26/35K/DTT/2P/ELUME	26	G24d-3	3 500	82	10 000	1 540	6 ¹³ / ₁₆	6/96
4-pin Double Twin Tube									
14117	PL13/30K/DTT/4P/ELUME	13	G24q-1	3 000	82	10 000	810	5 ⁵ / ₃₂	6/96
14120	PL18/30K/DTT/4P/ELUME	18	G24q-2	3 000	82	10 000	1 035	5 ²⁵ / ₃₂	6/96

HID Lamp



BD17

Order code	Description	Watts (W)	Base	Shape	Color temp. (K)	ANSI code	CRI	Life L70 (hrs)	Lumen output (lm)	Mean lumens (lm)	Burn pos.	Finish	Luminaire	Case qty (master)
Pulse Start														
58514	MH70W/C/U/PS/ELUME	70	E26	BD17	3 700	M98	70	15 000	5 300	3 400	U	Coated	Enclosed	24
58517	MH100W/C/U/PS/ELUME	100	E26	BD17	3 700	M90	70	15 000	8 500	5 500	U	Coated	Enclosed	24

Fluorescent Lamp



Order code	Description	Watts (W)	Base	Color temp. (K)	CRI	Rated life IS 3-12 hrs ²	Lumen output (lm)	Mean lumens (lm)	Nominal length (in.) (mm)	Efficacy (lm/W)	Case qty (master)
T8 Preheat Start											
56514 ¹	F15T8/CW/PH/G13/ELUME	15	Med Bipin	4 100	62	6 000-7 500	610	573	18 457	41	48
56515 ¹	F15T8/DL/PH/G13/ELUME	15	Med Bipin	6 500	72	6 000-7 500	560	526	18 457	37	48

Order code	Description	Watts (W)	Base	Color temp. (K)	CRI	Rated life IS 3-12 hrs ²	Rated life PS/PRS 3-12 hrs ²	Lumen output (lm)	Mean lumens (lm)	Nominal length (in.) (mm)	Efficacy (lm/W)	Case qty (master)
T8 800 Series - Rapid Start												
62513 ¹	F32T8/35K/8/RS/G13/ELUME/BULK	32	Med Bipin	3 500	85	24 000-30 000	40 000-42 000	3 050	2 900	48 1 220	95	25
62514 ¹	F32T8/41K/8/RS/G13/ELUME/BULK	32	Med Bipin	4 100	85	24 000-30 000	40 000-42 000	3 000	2 850	48 1 220	94	25
62515 ¹	F32T8/50K/8/RS/G13/ELUME/BULK	32	Med Bipin	5 000	85	24 000-30 000	40 000-42 000	2 950	2 800	48 1 220	92	25
62516 ¹	F32T8/65K/8/RS/G13/ELUME/BULK	32	Med Bipin	6 500	85	24 000-30 000	40 000-42 000	2 900	2 750	48 1 220	91	25



Order code	Description	Watts (W)	Base	Color temp. (K)	CRI	Rated life IS 3-12 hrs ²	Lumen output (lm)	Mean lumens (lm)	Nominal length (in.) (mm)	Efficacy (lm/W)	Case qty (master)
T5 Preheat Start											
56510	F6T5/CW/PH/G5/ELUME	6	Min Bipin	4 100	62	6 000-7 500	240	225	9 229	40	48
56511	F6T5/DL/PH/G5/ELUME	6	Min Bipin	6 500	62	6 000-7 500	210	197	9 229	35	48
56512	F8T5/CW/PH/G5/ELUME	8	Min Bipin	4 100	62	6 000-7 500	350	329	12 305	44	48
56513	F8T5/DL/PH/G5/ELUME	8	Min Bipin	6 500	62	6 000-7 500	310	291	12 305	39	48
56518	F13T5/WW/PH/G5/ELUME	13	Min Bipin	3 000	62	6 000-7 500	800	752	21 530	62	48
57392	F13T5/CW/PH/G5/ELUME	13	Min Bipin	4 100	62	6 000-7 500	740	695	21 530	57	48

¹TCLP compliant

² Based on a 3 hour and 12 hour start

IS=Instant Start ballast

PS=Program Start ballast

PRS=Program Rapid Start ballast

Order code	Description	Watts (W)	Base	Color temp. (K)	CRI	Rated life PS/PRS 3-12 hrs ²	Lumen output (lm)	Mean lumens (lm)	Nominal length (in.) (mm)	Efficacy (lm/W)	Case qty (master)
------------	-------------	-----------	------	-----------------	-----	---	-------------------	------------------	---------------------------	-----------------	-------------------

T5 Program Start

59187 ¹	F14T5/35K/8/PS/G5/ELUME	14	Min Bipin	3 500	85	24 000-30 000	1 350	1 280	22 559	96	25
59188 ¹	F14T5/41K/8/PS/G5/ELUME	14	Min Bipin	4 100	85	24 000-30 000	1 350	1 280	22 559	96	25
59189 ¹	F14T5/50K/8/PS/G5/ELUME	14	Min Bipin	5 000	85	24 000-30 000	1 300	1 230	22 559	93	25
59190 ¹	F21T5/35K/8/PS/G5/ELUME	21	Min Bipin	3 500	85	24 000-30 000	2 100	2 000	34 864	100	25
59191 ¹	F21T5/41K/8/PS/G5/ELUME	21	Min Bipin	4 100	85	24 000-30 000	2 100	2 000	34 864	100	25
59192 ¹	F21T5/50K/8/PS/G5/ELUME	21	Min Bipin	5 000	85	24 000-30 000	2 100	2 000	34 864	100	25
59196 ¹	F28T5/35K/8/PS/G5/ELUME	28	Min Bipin	3 500	85	24 000-30 000	2 900	2 750	46 1 168	104	25
59197 ¹	F28T5/41K/8/PS/G5/ELUME	28	Min Bipin	4 100	85	24 000-30 000	2 900	2 750	46 1 168	104	25
59198 ¹	F28T5/50K/8/PS/G5/ELUME	28	Min Bipin	5 000	85	24 000-30 000	2 750	2 610	46 1 168	98	25

T5 HO Program Start

59193 ¹	F24T5/35K/8/HO/PS/G5/ELUME	24	Min Bipin	3 500	85	24 000-30 000	2 000	1 900	22 559	83	25
59194 ¹	F24T5/41K/8/HO/PS/G5/ELUME	24	Min Bipin	4 100	85	24 000-30 000	2 000	1 900	22 559	83	25
59195 ¹	F24T5/50K/8/HO/PS/G5/ELUME	24	Min Bipin	5 000	85	24 000-30 000	1 900	1 805	22 559	79	25
59201 ¹	F39T5/50K/8/HO/PS/G5/ELUME	39	Min Bipin	5 000	85	24 000-30 000	3 500	3 325	34 864	90	25
65494	F54T5/35K/8/HO/PS/G5/ELUME	54	Min Bipin	3 500	85	35 000-40 000	5 000	4 651	46 1 168	83	25
65495	F54T5/41K/8/HO/PS/G5/ELUME	54	Min Bipin	4 100	85	35 000-40 000	5 000	4 450	46 1 168	93	25
65497	F54T5/50K/8/HO/PS/G5/ELUME	54	Min Bipin	5 000	85	35 000-40 000	4 900	4 465	46 1 168	77	25



Ø 1 5/32" (29.5 mm)

Order code	Description	Watts (W)	Base	Color temp. (K)	CRI	Life L70 (hrs)	Lumen output (lm)	Mean lumens (lm)	Nominal length (in.) (mm)	Efficacy (lm/W)	Case qty (master)
------------	-------------	-----------	------	-----------------	-----	----------------	-------------------	------------------	---------------------------	-----------------	-------------------

CIRCLINE Rapid Start

56516	FC8T9/CW/RS/4P/ELUME	22	Circline 4-Pin	4 100	60	12 000	1 150	1 095	9 229	52	24
56517	FC12T9/CW/RS/4P/ELUME	32	Circline 4-Pin	4 100	85	12 000	1 570	1 495	12 305	49	24

¹TCLP compliant

² Based on a 3 hour and 12 hour start

IS=Instant Start ballast

PS=Program Start ballast

PRS=Program Rapid Start ballast



Printed in Canada.

© 2021 STANDARD Products Inc. All Rights Reserved.

Data is based upon tests performed in a controlled environment.
Actual performance can vary depending on operating conditions.
All products are subject to change or may be discontinued any time without notice.

For the latest version, please refer to our website.

www.standardpro.com



STANPRO



standardpro.com

STANPRO