

**One range for every application**  
Monitoring and controlling with SIRIUS Relays



# sirius

## RELAYS

**SIEMENS**

# The wide range of SIRIUS Relays: A relay for every application

Every engineer knows that he must be completely up-to-date when it comes to controls, load feeders and drives. However, with coupling, control and monitoring relays, the search for various suppliers becomes time consuming. This is now a thing of the past because we have all of these products in just one family: SIRIUS®. This makes it easy for you to select the optimum product and guarantees you a top price/performance ratio.

In our assortment of SIRIUS Relays, you can find everything you need for motor feeders. Simple and easy. From a single source. Whether you need timing or reliable monitoring relays, narrow coupling relays, plug-in relays, low-noise power relays or interface converters – it would be difficult to find a more complete and extensive range of relays. We have a relay for simply every application.

All SIRIUS Relays are especially easy to use – across the product range. Please take a closer look at our range and see for yourself. You'll be quite impressed.

**SIRIUS Relays – a complete range to cover every application.**

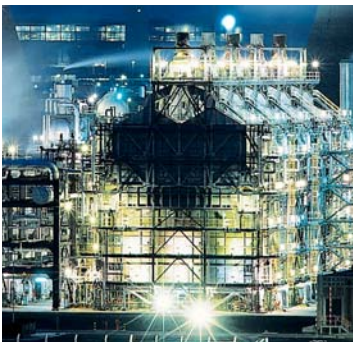







## The highlights at a glance:

- An extensive range: A matching relay for every application
- User-friendly: Extremely simple to operate
- Multi-functional: Relays with a high degree of versatility
- In-line with requirements from practice:  
Actually graduated regarding the performance
- Excellent price/performance ratio

*All systems go:*

*Everything runs smoothly with our SIRIUS timing, monitoring and coupling relays. Whether in production environments or in transportation systems, when monitoring motors and equipment or controlling complex plants and systems: Our relays have a handle on everything from the word go.*



<b>Timing relays</b>		3RP15/3RP20 for rail mounting	4/5
<b>Monitoring relays for line monitoring</b>		3UG monitoring relays for voltage, line and insulation	6/7
<b>Monitoring relays for load monitoring</b>		3UG4 monitoring relays for single-phase current, power factor and active current monitoring	8/9
<b>Monitoring relays for residual-current monitoring</b> <b>NEW!</b>		3UG4 monitoring relays for residual-current monitoring	10/11
<b>Further monitoring relays</b> <b>NEW!</b>		3UG4 monitoring relays for level and speed	12/13
<b>Thermistor motor protection</b>		3RN1	14/15
<b>Temperature monitoring relays</b>		3RS10/3RS11 analog adjustable relays	16/17
		3RS10/3RS11/3RS20/3RS21 digitally adjustable relays	18/19
<b>Coupling relays, narrow design</b>		3TX701 relay couplers, plug-in	20/21
		3TX700 relay couplers, cannot be plugged-in	
		3TX70 semiconductor couplers	22/23
<b>Plug-in relays</b> <b>NEW!</b>		3RS18 relay couplers	24
		LZS plug-in relays Complete devices	25/26
<b>Converters</b>		LZX/LZS plug-in relays Single modules	26/27
		3RS17 interface converters Normalized signal and universal converter	28/29
<b>Power relays</b>		3TG10	30
<b>Power supplies</b>		SITOP Power	31

# 3RP15/3RP20 Timing Relays for rail mounting

Electronic 3RP1/3RP2 timing relays are used for all switching operations in starting, protection and open- and closed-loop control circuits that require time delay functions. Due to their well-proven concept and their space-saving, compact design, they are the ideal timing devices for cabinet, panel and control manufacturers from all areas of industry.

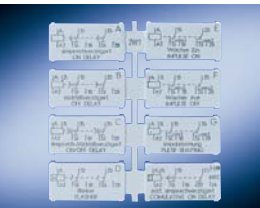

## Applications:

### On delay:

- Noise pulses are suppressed
- Motors are started step-by-step to ensure that the line supply is not subject to excessive stress.

### Off delay:

- Run-on functions are generated after the control voltage is removed (fan run-on)
- Emergency shutdown or to bring a plant or system into a defined state when the power supply voltage has failed

### Star/delta:

- Motors are changed-over from a star to a delta configuration with a fixed interval time of 50 ms in order to prevent short circuits between phases

## Your advantages:

- All versions have removable terminals
- All versions with screw terminals or with the innovative spring-loaded terminal system
- Labels are used to document the function that has been set at multi-functional timing relays
- Transparent range for every application: Only seven basic devices
- Significant advantages when using multi-function timing relays with wide-range voltage
- Optimum price/performance ratio
- Positively-driven relay contacts can be used in safety-relevant circuits up to Category 2 according to DIN EN 954-1
- Hard-gold-plated relay contacts for optimum interaction with electronic controls
- Sealable cover to secure parameters that have been set

## Engineering information:

- For the "clock-pulse" function, pulse and interval can be separately set, for the flashing function it is pulse and interval 1:1
- "Time addition" function (no holding on supply failure function) for the multi-function relays: By activating the start contact





## Electronic 3RP15 timing relays in an industrial enclosure, 22.5 mm

8 functions	1 CO (changeover contact)	0.05 s–100 h	12 V DC	3RP1505-□AA40
8 functions	1 CO	0.05 s–100 h	AC/DC 24/100–127 V AC	3RP1505-□AQ30
8 functions	1 CO	0.05 s–100 h	AC/DC 24/200–240 V AC	3RP1505-□AP30
8 functions	1 CO	0.05 s–100 h	24–240 V AC/DC	3RP1505-□AW30
8 functions	2 CO	0.05 s–100 h	24–240 V AC/DC	3RP1505-□RW30 <sup>1)</sup>
16 functions	2 CO	0.05 s–100 h	AC/DC 24/100–127 V AC	3RP1505-□BQ30
16 functions	2 CO	0.05 s–100 h	AC/DC 24/200–240 V AC	3RP1505-□BP30
16 functions	2 CO	0.05 s–100 h	24–240 V AC/DC	3RP1505-□BW30
16 functions	2 CO	0.05 s–100 h	400–440 V AC	3RP1505-1BT20 <sup>2)</sup>
On delay	1 CO	0.5–10 s	AC/DC 24/100–127 V AC	3RP1511-□AQ30
On delay	1 CO	0.5–10 s	AC/DC 24/200–240 V AC	3RP1511-□AP30
On delay	1 CO	1.5–30 s	AC/DC 24/100–127 V AC	3RP1512-□AQ30
On delay	1 CO	1.5–30 s	AC/DC 24/200–240 V AC	3RP1512-□AP30
On delay	1 CO	5–100 s	AC/DC 24/100–127 V AC	3RP1513-□AQ30
On delay	1 CO	5–100 s	AC/DC 24/200–240 V AC	3RP1513-□AP30
On delay	1 CO	0.05 s–100 h	AC/DC 24/100–127 V AC	3RP1525-□AQ30
On delay	1 CO	0.05 s–100 h	AC/DC 24/200–240 V AC	3RP1525-□AP30
On delay	2 CO	0.05 s–100 h	42–48/60 V AC/DC	3RP1525-□BR30
On delay	2 CO	0.05 s–100 h	AC/DC 24/100–127 V AC	3RP1525-□BQ30
On delay	2 CO	0.05 s–100 h	AC/DC 24/200–240 V AC	3RP1525-□BP30
On delay	2 CO	0.05 s–100 h	24–240 V AC/DC	3RP1525-□BW30
On delay, 2-wire	1 NO contact, solid-state	0.05–240 s	24–66 V AC/DC	3RP1527-□EC30
On delay, 2-wire	1 NO contact, solid-state	0.05–240 s	90–240 V AC/DC	3RP1527-□EM30
Off delay with auxiliary voltage	1 CO	0.5–10 s	AC/DC 24/100–127 V AC	3RP1531-□AQ30
Off delay with auxiliary voltage	1 CO	0.5–10 s	AC/DC 24/200–240 V AC	3RP1531-□AP30
Off delay with auxiliary voltage	1 CO	1.5–30 s	AC/DC 24/100–127 V AC	3RP1532-□AQ30
Off delay with auxiliary voltage	1 CO	1.5–30 s	AC/DC 24/200–240 V AC	3RP1532-□AP30
Off delay with auxiliary voltage	1 CO	5–100 s	AC/DC 24/100–127 V AC	3RP1533-□AQ30
Off delay with auxiliary voltage	1 CO	5–100 s	AC/DC 24/200–240 V AC	3RP1533-□AP30
Off delay without auxiliary voltage	1 CO	0.05–100 s	24 V AC/DC	3RP1540-□AB30
Off delay without auxiliary voltage	1 CO	0.05–100 s	100–127 V AC/DC	3RP1540-□AJ30
Off delay without auxiliary voltage	1 CO	0.05–100 s	200–240 V AC/DC	3RP1540-□AN30
Off delay without auxiliary voltage	2 CO	0.05–100 s	24 V AC/DC	3RP1540-□BB30
Off delay without auxiliary voltage	2 CO	0.05–100 s	100–127 V AC/DC	3RP1540-□BJ30
Off delay without auxiliary voltage	2 CO	0.05–100 s	200–240 V AC/DC	3RP1540-□BN30
Clock-pulse relay	1 CO	0.05 s–100 h	42–48/60 V AC/DC	3RP1555-□AR30
Clock-pulse relay	1 CO	0.05 s–100 h	AC/DC 24/100–127 V AC	3RP1555-□AQ30
Clock-pulse relay	1 CO	0.05 s–100 h	AC/DC 24/200–240 V AC	3RP1555-□AP30
Star/delta with run-on function	3 x 1 NO contact	1–20 s, 30–600 s (run-on)	AC/DC 24/100–127 V AC	3RP1560-□SQ30
Star/delta with run-on function	3 x 1 NO contact	1–20 s, 30–600 s (run-on)	AC/DC 24/200–240 V AC	3RP1560-□SP30
Star/delta	1 NO contact + 1 NO contact	1–20 s	AC/DC 24/100–127 V AC	3RP1574-□NQ30
Star/delta	1 NO contact + 1 NO contact	1–20 s	AC/DC 24/200–240 V AC	3RP1574-□NP30
Star/delta	1 NO contact + 1 NO contact	3–60 s	AC/DC 24/100–127 V AC	3RP1576-□NQ30
Star/delta	1 NO contact + 1 NO contact	3–60 s	AC/DC 24/200–240 V AC	3RP1576-□NP30

## Electronic 3RP20 timing relays in the SIRIUS design, 45 mm

Function	Contact elements	Time range	Control supply voltage	Order No.
8 functions	1 CO (changeover contact)	0.05 s–100 h	AC/DC 24/100–127 V AC	3RP2005-□AQ30
8 functions	1 CO	0.05 s–100 h	AC/DC 24/200–240 V AC	3RP2005-□AP30
On delay	1 CO	0.05 s–100 h	AC/DC 24/100–127 V AC	3RP2025-□AQ30
On delay	1 CO	0.05 s–100 h	AC/DC 24/200–240 V AC	3RP2025-□AP30
16 functions	2 CO	0.05 s–100 h	24–240 V AC/DC	3RP2005-□BW30

<sup>1)</sup> Positively-driven and hard-gold-plated relay contacts

<sup>2)</sup> This device is only available with screw terminals

Screw terminal **1**

Spring-loaded terminal **2**

# 3UG Monitoring Relays

for line, single-phase voltage and insulation monitoring



The new 3UG4 monitoring relays provide a maximum degree of protection for machines, plants and systems. This means that line and voltage faults are detected early and the appropriate response is initiated before more significant damage can occur.

### Your advantages:

- Due to the wide voltage range it can be used on all line supplies around the world – from 160 V to 690 V – without an auxiliary voltage
- Can be set to overrange, underrange and window monitoring
- Freely parameterizable delay times and reset functions
- Reduced width for all versions for line and voltage monitoring
- For the digital versions, the actual value and fault type are displayed
- Automatic rotation direction correction by differentiating between line faults and incorrect phase sequence
- All versions have removable terminals
- All versions have either screw terminals or alternatively innovative spring-loaded terminals

### Applications:

The applications are listed in the following table. These tables indicate the various equipment/system conditions that can be detected using the monitoring parameters.

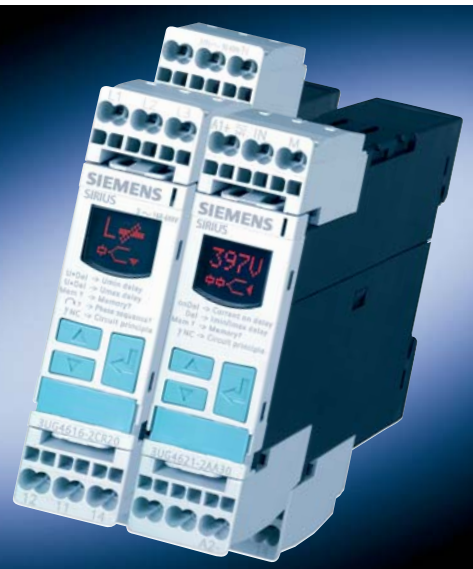

### Configuration of a 3-phase monitoring function

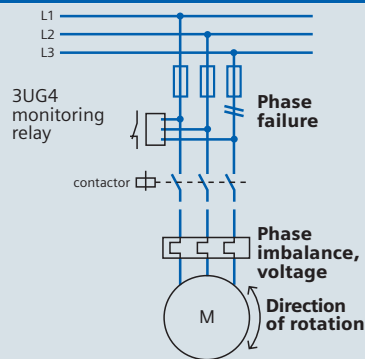

Measured quantity	Possible plant or system fault
<b>Phase sequence</b>	<ul style="list-style-type: none"> <li>• Direction of rotation of the drive</li> </ul>
<b>Phase failure</b>	<ul style="list-style-type: none"> <li>• A fuse has blown</li> <li>• Control supply voltage has failed</li> <li>• Single-phase operation of a motor with corresponding overheating</li> </ul>
<b>Phase dissymmetry</b>	<ul style="list-style-type: none"> <li>• Motor overheating as a result of non-symmetrical voltages or phase failure</li> <li>• Line supplies with non-symmetrical load are detected</li> <li>• A phase failure is detected in spite of regenerative feedback</li> </ul>
<b>Undervoltage</b>	<ul style="list-style-type: none"> <li>• Motor draws an increased current and in turn overheats</li> <li>• A device is undesirably reset</li> <li>• Detection of line supply dips, especially when supplied from a battery</li> <li>• Threshold value switch for analog signals 0 to 10 V</li> </ul>
<b>Overvoltage</b>	<ul style="list-style-type: none"> <li>• A plant is protected against destruction due to supply overvoltages</li> <li>• A plant or system switches-in above a certain voltage</li> <li>• Threshold value switch for analog signals 0 to 10 V</li> </ul>
<b>Insulation monitoring</b>	<ul style="list-style-type: none"> <li>• The insulation resistance for non-grounded plants and systems is monitored</li> </ul>

### 3UG4 monitoring relays for line supply and three-phase voltages

Phase sequence	Phase failure	Phase imbalance	Hysteresis	Under-voltage	Over-voltage	N-conductor monitoring	Delay times	Contacts	Line supply voltage	Order No.
22.5 mm wide 3UG4614 to 3UG4618 can be digitally set, with fault memory and with LCD display										
Yes	Conditional <sup>1)</sup>	–	–	–	–	–	–	1 CO	160–260 320–500 420–690	3UG4511-□AN20 3UG4511-□AP20 3UG4511-□AQ20
								2 CO	160–260 320–500 420–690	3UG4511-□BN20 3UG4511-□BP20 3UG4511-□BQ20
Yes	Yes	10%	–	–	–	–	–	1 CO	160–690	3UG4512-□AR20
								2 CO	160–690	3UG4512-□BR20
Yes	Yes	20%	5%	160–690 V	–	–	Off delay 0.1–20 s	2 CO	160–690	3UG4513-□BR20
Selectable	Yes	0 or 5–20%	1–20 V	160–690 V	–	–	On and off delay 0.1–20 s	2 CO	160–690	3UG4614-□BR20
Selectable	Yes	Using threshold values	1–20 V	160–690 V	160–690 V	–	0.1–20 s for $V_{\min}$ and $V_{\max}$	1 CO for $V_{\min}$ and $V_{\max}$	160–690	3UG4615-□CR20
Selectable	Yes	Using threshold values	1–20 V	160–690 V	160–690 V (90–400 w.r.t. N)	Yes	0.1–20 s for $V_{\min}$ and $V_{\max}$	1 CO for $V_{\min}$ and $V_{\max}$	160–690 (90–400 w.r.t. N)	3UG4616-□CR20
Autom. correction	Yes	0 or 5–20%	1–20 V	160–690 V	160–690 V	–	Off delay 0.1–20 s	1 CO for line faults and 1 CO for phase sequence	160–690	3UG4617-□CR20
Autom. correction	Yes	0 or 5–20%	1–20 V	160–690 V	160–690 V (90–400 w.r.t. N)	Yes	Off delay 0.1–20 s	1 CO for line faults and 1 CO for phase sequence	160–690 (90–400 w.r.t. N)	3UG4618-□CR20

Screw terminal **1**  
Spring-loaded terminal **2**

#### <sup>1)</sup> Return voltage due to coupling between the individual phases

The 3UG4511 device can not detect phase failures reliably.

Loads connected to the three-phase line supply – such as motor windings, lamps, transformers – result in a coupling between the individual phases.

As a result of this coupling, there is always a return voltage at the equipment terminal of the phase that has failed.

### Single-phase voltage monitoring

Measuring range	Hysteresis	Contacts	Delay time	Auxiliary voltage	Order No.
22.5 mm wide, all of the devices can be digitally set and have an LCD display, a fault memory that can be switched-in, simultaneous monitoring for overvoltage and undervoltage over the complete measuring range					
17–275 V AC/DC	0.1–150 V	1 CO	0–20 s	Self-supplied	3UG4633-□AL30
0.1–60 V AC/DC	0.1–30 V	1 CO	0–20 s	24 V AC/DC	3UG4631-□AA30
				24–240 V AC/DC	3UG4631-□AW30
10–600 V AC/DC	0.1–300 V	1 CO	0–20 s	24 V AC/DC	3UG4632-□AA30
				24–240 V AC/DC	3UG4632-□AW30

### Insulation monitoring for IT line supplies

Line supply	Measuring range	Auto reset/fault memory	Contacts	Width	Auxiliary voltage	Order No.
AC	1–110 kΩ	Selectable	1 CO	45 mm	115/230 V AC	3UG3081-1AK20
					24–240 V AC	3UG3081-1AW30
DC	10–110 kΩ	Selectable	1 CO	45 mm	24–240 V AC	3UG3082-1AW30

Screw terminal **1**  
Spring-loaded terminal **2**

# 3UG4 Monitoring Relays

for single-phase current, power factor and active current monitoring

**3UG4 relays that monitor current, power factor and active current are ideal for monitoring the load of motors and the functionality of electronic loads. These devices detect the effect of wear and faults early on. This means that appropriate actions can be taken long before more significant damage occurs.**



#### Your advantages:

- Wide-voltage versions reduce inventory stock levels
- Variable settings for overrange, under-range or window monitoring
- Freely parameterizable delay times and reset switch
- Actual value and fault type are permanently displayed
- All versions have removable terminals
- All versions have screw terminals or innovative spring-loaded terminals



#### Current monitoring:

- Only two versions from 2 mA to 10 A
- Real effective value measurement
- Applicable for frequencies with 40–500 Hz AC and DC

#### Power factor and active current monitoring:

- Global application thanks to wide-range voltage between 90 and 690 V AC
- Capable of monitoring even small single-phase motors with a no-load running current below 0.5 A
- Easy identification of threshold values thanks to direct relationship between the measurement and the motor load
- Window monitoring and active current measurement allow for easy identification of cable breakage between control cabinet and motor as well as phase failure
- Monitoring of the motor load independent of the main voltage
- Selectable power factor or  $I_{res}$  (active current) measuring principle

#### Applications:

The applications can be seen in the adjacent table. These tables show the various equipment/system states that can be detected using the monitoring parameters.



### 3UG4 monitoring relays – single-phase current monitoring

Measuring range	Hysteresis	Contacts	Starting-bypass time	Tripping delay	Control supply voltage	Order No.
22.5 mm wide, all of the devices can be digitally set and have an LCD display, a fault memory that can be switched-in, simultaneous monitoring for overcurrent and undercurrent over the complete measuring range						
3.0 mA AC/DC up to 500 mA AC/DC	0.1 mA–250 mA	1 CO	0.1–20 s	0.1–20 s	24 V AC/DC	3UG4621-□AA30
					24–240 V AC/DC	3UG4621-□AW30
0.05 A AC/DC up to 10 A AC/DC	0.01 A–5 A	1 CO	0.1–20 s	0.1–20 s	24 V AC/DC	3UG4622-□AA30
					24–240 V AC/DC	3UG4622-□AW30

Screw terminal **1**

Spring-loaded terminal **2**

### Power factor and active current monitoring

Measuring range for power factor	Measuring range for active current $I_{res}$	Power factor hysteresis	Active current hysteresis	On delay	Tripping delay	Rated control supply voltage	Order No.
22.5 mm wide, all of the devices can be digitally set and have an LCD display, a fault memory that can be switched-in, simultaneous power factor and active current monitoring over the entire measuring range							
0.1–0.99 ( $\cos \varphi$ )	0.2–10.0 A	0.1 ( $\cos \varphi$ )	0.1–2.0 A	0–99 s	0.1–20.0 s	90–690 V AC	3UG4641-□CS20

### Current and $\cos \varphi$ as a function of the motor load

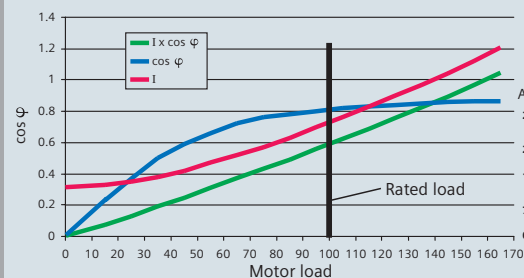

Rule of thumb:  
 $\cos \varphi$  changes significantly below the rated load;  
 the current increases overproportionally above the rated load.

The  $I_{res}$  active current shows a linear correlation between the motor load and the measured value over the entire measuring range.

Monitoring parameter	Plant/system states
<b>Current monitoring</b>	<ul style="list-style-type: none"> <li>• Overload monitoring</li> <li>• Underload monitoring close to the rated torque</li> <li>• Monitoring the functionality of electric loads</li> <li>• Wire breakage monitoring</li> <li>• Energy management (phase current monitoring)</li> <li>• Threshold value switch for analog signals up to 20 mA</li> </ul>
<b>Power factor and active current monitoring</b>	<ul style="list-style-type: none"> <li>• No-load monitoring</li> <li>• Underload monitoring in the lower power range</li> <li>• Overload monitoring</li> <li>• Extremely simple power factor monitoring of line supplies to control compensation equipment</li> <li>• Energy management</li> <li>• Interrupted cable between the cabinet and the motor</li> </ul>

# 3UG4 Monitoring Relays

## for residual-current monitoring

Over time, systems may experience insulation problems caused by humidity or severe contamination. These problems cause residual currents which may result in fatal personal and also system damage.

Using the 3UG4624 residual-current monitoring relay in combination with a 3UL22 summation current transformer, such hazards can be eliminated. Due to adjustable limit or warning threshold values, the relay issues a warning before the limit value is reached and switches off when the limit value is exceeded after a certain delay time.



### Your advantages:

- Global applicability due to wide voltage range from 90 V AC to 690 V AC
- Variably adjustable threshold values for warning and disconnection
- Freely parameterizable delay times and reset behavior
- Permanent display of the actual value and fault diagnostics via display
- Removable terminal and optional screw-terminal or innovative spring-loaded terminal
- High flexibility and space savings due to the converter's assembly outside the control cabinet

### Application areas:

Protection and monitoring of systems prone to residual currents, e.g. caused by:

- Dust deposits or humidity
- Porous cables and lines
- Capacitive residual currents



**3UG4 monitoring relays – for residual-current monitoring**

**NEW!**

Display range	Setting ranges for warning and disconnection	Contacts	Hysteresis with threshold value	Hysteresis with warning value	ON delay	Tripping delay time	Rated control supply voltage	Order No.
Width 22.5 mm, digitally adjustable featuring LCD display, connectable fault memory, monitoring of warning threshold and limit value exceedance, for 3UL22 summation current transformer with $I_{\Delta n}$ from 0.3 to 40 A								
10 to 120% of the nominal transformer value in A	10 to 100% of the nominal transformer value in A	1 CO + 1 CO	Display accuracy of up to 50% of the nominal transformer value in A	5% fixed of the nominal transformer value in A	0.1–20.0 s	0.1–20.0 s	90–690 V AC	<b>3UG4624-□CS20</b>

- Screw terminal **1**
- Spring-loaded terminal **2**

**3UL22 summation current transformer for external ground fault monitoring**

Rated insulation voltage $U_i$	Rated residual current $I_{\Delta n}$	Through hole diameter	For Protodur cable (for through-connection)	Order No.
Detection of residual currents in machines and systems				
690 V AC	0.3 A	40 mm	max. 4 x 95 mm <sup>2</sup>	<b>3UL2201-1A</b>
	0.5 A			<b>3UL2201-2A</b>
	1 A			<b>3UL2201-3A</b>
690 V AC	0.3 A	65 mm	max. 4 x 240 mm <sup>2</sup>	<b>3UL2202-1A</b>
	0.5 A			<b>3UL2202-2A</b>
	1 A			<b>3UL2202-3A</b>
	10 A			<b>3UL2202-2B</b>
	16 A			<b>3UL2202-3B</b>
	25 A			<b>3UL2202-4B</b>
	40 A			<b>3UL2202-5B</b>
1000 V AC	0.3 A	120 mm	max. 8 x 300 mm <sup>2</sup>	<b>3UL2203-1A</b>
	0.5 A			<b>3UL2203-2A</b>
	1 A			<b>3UL2203-3A</b>
	6 A			<b>3UL2203-1B</b>
	10 A			<b>3UL2203-2B</b>

# 3UG4 Monitoring Relays

## for level and speed



**3UG4 monitoring relays also detect non-electrical parameters.**

**Our 3UG4501 level monitoring relays offer reliable 1- or 2-point regulations and alarm messages in case of overflow or dry running on the basis of a simple principle: Almost all liquids are conductive, which is utilized for the monitoring of filling levels. If the probes are immersed in the liquid, the current flows – if the probes fall dry, no current flows.**

**The 3UG4651 speed monitoring relays monitor the setpoint speed of motors for any exceedance of the upper or lower limit. Implementing a periodic continuous measuring, they monitor the pulses per rotation delivered to the sensors attached to the motor. Furthermore, the relays are suitable for all functions requiring the monitoring of a continuous pulse signal, e.g. belt operation and clock time monitoring or bypass control.**



### Level monitoring

#### Your advantages:

- Global applicability due to wide voltage range from 24 to 240 V AC
- 2- and 3-pole wire electrodes for ease of mounting from the top/bottom which can be individually trimmed
- Bar-type electrodes for lateral mounting for higher filling levels and minimum space requirements
- Flexible adjustment to various conductive liquids due to analog sensitivity setting from 2 to 200 kOhm
- Compensation of wave movements due to tripping delay times from 0.1 to 10 seconds
- Selectable supply or discharge function
- All designs featuring removable terminals and optional screw-terminals or innovative spring-loaded terminals

#### Application areas:

- 1- and 2-point level monitoring
- Overflow protection
- Dry running protection
- Leakage monitoring

### Speed monitoring

#### Your advantages:

- Global applicability due to wide voltage range from 24 to 240 V AC
- Variable adjustment to upper or lower limit exceedance or window monitoring
- Freely parameterizable delay times and reset behavior
- Permanent display of actual value or fault type
- Use of up to 10 sensors per rotation with extremely slowly rotating motors
- All designs featuring removable terminals and optional screw-terminals or innovative spring-loaded terminals
- Two- or three-conductor sensors and sensors with mechanical switching or electronic output connectable
- Integrated auxiliary voltage for sensor

#### Application areas:

- Slip/breakage of a belt drive
- Load shedding
- Standstill monitoring (no personal protection)
- Transport item monitoring for completeness



**3UG4 monitoring relays for 1- and 2-point level monitoring of conductive liquids**

**NEW!**

Sensitivity	Contacts	Tripping delay time	Width	Control supply voltage	Order No.
2–200 kΩ	1 CO	0.1–10 s	22.5 mm	24 V AC/DC	3UG4501-□AA30
				24–240 V AC/DC	3UG4501-□AW30

**Probes for level monitoring**

Description	Cable connection	Number of poles	Order No.
Wire electrode, 500 mm long, with Teflon insulation, max. operating temperature 90 °C, max. operating pressure 10 bar	3 x 0.5 mm <sup>2</sup> , 2 m	3-pole	3UG3207-3A
	2 x 0.5 mm <sup>2</sup> , 2 m	2-pole	3UG3207-2A
Bar-type electrode for lateral mounting, max. operating temperature 90 °C, max. operating pressure 10 bar	3 x 0.5 mm <sup>2</sup> , 2 m	2-pole	3UG3207-2B
	2 x 0.5 mm <sup>2</sup> , 2 m	1-pole	3UG3207-1B
Rod-type electrode, rugged, max. operating temperature 90 °C, max. operating pressure 10 bar	2 x 0.5 mm <sup>2</sup> , 2 m	1-pole	3UG3207-1C



3UG 3207-3A



3UG 3207-2B



3UG 3207-1C

- Screw terminal **1**
- Spring-loaded terminal **2**

**1- and 2-point level monitoring, overflow protection**

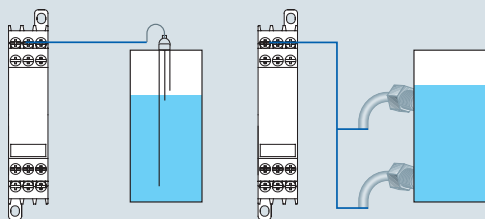

This method is applicable to very many liquids and substances; prerequisite: specific resistance < 200 kΩ

Product	kΩ	Product	kΩ
Buttermilk	1	Natural water	5
Fruit juice	1	Waste water	5
Vegetable juice	1	Starch solution	5
Milk	1	Oil	10
Soup	2.2	Condensed water	18
Beer	2.2	Soap foam	18
Coffee	2.2	Jams	45
Ink	2.2	Jellies	45
Salt water	2.2	Sugar solution	90
Wine	2.2	Whiskey	220
		Distilled water	450

**3UG4 monitoring relays for upper and lower speed exceedance monitoring**

**NEW!**

Measuring range	Contacts	Start-up bridging time	Tripping delay time	Width	Control supply voltage	Order No.
Pulse/min 0.1–2200 (10–36.67 Hz)	1 CO	1–900 s	0.1–99.9 s	22.5 mm	24 V AC/DC	3UG4651-□AA30
					24–240 V AC/DC	3UG4651-□AW30

**Speed monitoring**

**Without enable input**

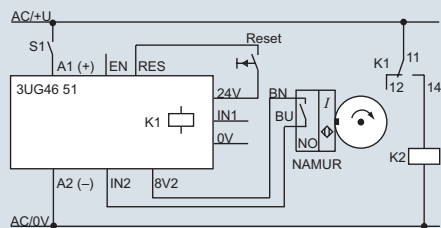

**With enable input**

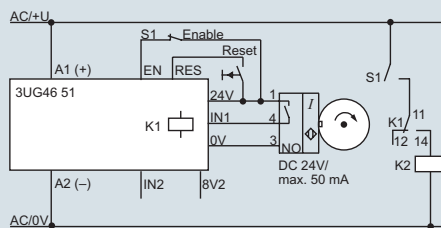

- Screw terminal **1**
- Spring-loaded terminal **2**

# 3RN1 Thermistor Motor Protection for overheating protection

**Thermistor motor protection relays provide decisive advantages where current-dependent protection using either a circuit-breaker or an overload relay is not the ideal solution: In some cases, often as a result of external effects, overheating can occur without being detected by the thermal image in the circuit-breaker or an overload relay. Examples include heavy-duty starting (e.g. centrifuges), operation with AC drive converters or frequent switching, braking operations or when cooling is restricted, e.g. due to accumulated dirt.**

## Your advantages:

- The motor winding temperature is directly measured
- Only one relay is required for all motor power ratings
- Device/terminal labeling acc. to DIN EN 50005 for “standard” switching relays and for overload protective devices
- Relays with hard-gold-plated contacts for use under difficult conditions
- LEDs indicate wire breakage and short circuit in the sensor circuit
- All relay versions are equipped with screw terminals or innovative spring-loaded terminals
- Version with protective separation up to 300 V according to DIN/VDE 0106 as well as versions with bistable relay for special applications
- ATEX certification for gases and dust
- All versions have removable terminals

## Application areas:

- “Alarm and trip” function by using two sensor circuits with different response temperatures – this means that it is possible to respond before shutting-down (additional cooling can be switched-in, the load reduced, etc.)
- Multi-motor protection using only one device, e.g. for conveyor lines – for several motors that must be shutdown together



**Thermistor motor protection relays for PTC thermistors (type A PTCs)**

All of the devices with the exception of 24 V AC/DC have electrical isolation

Version	Reset	Contacts	Control supply voltage	Order No.	
<b>Compact evaluation units, 22.5 mm wide, monostable, closed-circuit current principle, 1 LED</b>					
Terminal A1 is connected to the common of the changeover contact	Auto	1 CO	24 V AC/DC	3RN1000-□AB00	
			110 V AC	3RN1000-□AG00	
			230 V AC	3RN1000-□AM00	
<b>Standard evaluation units, 22.5 mm wide, monostable, closed-circuit current principle, 2 LEDs</b>					
Short circuits are detected in the sensor circuit	Auto	1 NO + 1 NC	24 V AC/DC	3RN1010-□CB00	
			110 V AC	3RN1010-□CG00	
			230 V AC	3RN1010-□CM00	
			24–240 V AC/DC	3RN1010-□CW00	
		2 CO	24 V AC/DC	3RN1010-□BB00	
			110 V AC	3RN1010-□BG00	
	2 CO hard-gold-plated	24 V AC/DC	3RN1010-□GB00		
		230 V AC 230 V	3RN1010-□BM00		
	Manual/remote <sup>3)</sup>	1 NO + 1 NC	24 V AC/DC	3RN1011-□CB00	
			110/230 V AC	3RN1011-□CK00	
	Holding on supply failure <sup>2)</sup>	Manual/remote <sup>3)</sup>	2 CO	24 V AC/DC	3RN1011-□BB00
				110 V AC	3RN1011-□BG00
230 V AC				3RN1011-□BM00	
Holding on supply failure <sup>2)</sup> , short circuits are detected in the sensor circuit	Manual/remote <sup>3)</sup>	2 CO hard-gold-plated	24 V AC/DC	3RN1011-□GB00	
			24 V AC/DC	3RN1012-□CB00	
			110/230 V AC	3RN1012-□CK00	
Holding on supply failure <sup>2)</sup> , short circuits are detected in the sensor circuit	Manual/remote <sup>3)</sup>	2 CO	24 V AC/DC	3RN1012-□BB00	
			110 V AC	3RN1012-□BG00	
			230 V AC	3RN1012-□BM00	
Holding on supply failure <sup>2)</sup> , short circuits and wire breakage in the sensor circuit are detected and displayed, wide-range voltage with screw terminals with protective separation <sup>1)</sup>	Manual/remote <sup>3)</sup>	2 CO	24 V AC/DC	3RN1013-□BB00	
			24–240 V AC/DC	3RN1013-1BW10 3RN1013-2BW00	
		2 CO hard-gold-plated	24–240 V AC/DC	3RN1013-1GW10 3RN1013-2GW00	
<b>Evaluation units for 2 sensor circuits, alarm and trip, 22.5 mm wide, monostable, closed-circuit current principle, 3 LEDs</b>					
Test/reset button, holding on supply failure <sup>2)</sup> ; the evaluation circuit for "alarm" uses an NO contact in the open-circuit principle	Manual/remote <sup>3)</sup>	1 NO + 1 NC	24–240 V AC/DC	3RN1022-□DW00	
<b>Evaluation units for 6 sensor circuits, multi-motor protection, 45 mm wide, monostable, closed-circuit current principle, 8 LEDs</b>					
Test/reset button, holding on supply failure <sup>2)</sup>	Manual/remote <sup>3)</sup>	1 NO + 1 NC	24–240 V AC/DC	3RN1062-□CW00	
<b>Bistable evaluation units, 22.5 mm wide</b>					
Test/reset button, holding on supply failure <sup>2)</sup> , short circuits and wire breakage in the sensor circuit are detected and displayed, bistable version, not tripped when the control supply voltage fails	Manual/remote <sup>3)</sup>	2 CO	24–240 V AC/DC	3RN1013-□BW01	

1) Protective separation up to 300 V according to DIN/VDE 0106

2) Information regarding the holding on supply failure, refer to Catalog LV 1, chapter 7

3) Reset using the reset button or by interrupting the control supply voltage

Screw terminal **1**Spring-loaded terminal **2**

# 3RS10/3RS11 Temperature Monitoring Relays

## Analog adjustable relays

**3RS10/11 relays are used to measure temperatures in solid, liquid and gaseous mediums. The temperature is measured using a sensor that is in the medium, evaluated by the unit and monitored to determine whether the temperature is within the upper and lower temperature limits. Depending on the function that has been parameterized, the output relay either switches on or off at these threshold values.**



### Your advantages:

- All versions have removable terminals
- Many versions are available with innovative spring-loaded terminals
- All devices have electrical isolation  
Exception: 24 V AC/DC
- Simple handling using a rotary potentiometer
- Selectable hysteresis
- For devices with two threshold values, the operating principle can be selected

### Applications:

- Protecting motors and equipment/systems
- Monitoring temperatures in electrical cabinets
- Frost monitoring
- Temperature limits for process quantities – e.g. in the packaging industry or galvanizing systems
- Controlling plants and machines such as HVAC systems, solar collectors, heat pumps or warm water supply systems
- Monitoring oil in bearings and gearboxes
- Monitoring cooling liquids



Screw terminal 1

Spring-loaded terminal 2

## 3RS10/3RS11 Temperature Monitoring Relays

Sensor	Function	Measuring range	Rated control supply voltage $V_s$ 50–60 Hz AC	Order No.
<b>Analog adjustable, 1 threshold value, 22.5 mm wide; analog closed-circuit principle, no holding on supply failure function; 1 NO + 1 NC</b>				
PT100 (resistance sensor)	Overrange	–50...+50 °C	24 V AC/DC	3RS10 00-□CD00
			110/230 V AC	3RS10 00-□CK00
		0...+100 °C	24 V AC/DC	3RS10 00-□CD10
			110/230 V AC	3RS10 00-□CK10
		0...+200 °C	24 V AC/DC	3RS10 00-□CD20
	110/230 V AC		3RS10 00-□CK20	
	Underrange	–50...+50 °C	24 V AC/DC	3RS10 10-1CD00
			110/230 V AC	3RS10 10-1CK00
		0...+100 °C	24 V AC/DC	3RS10 10-1CD10
			110/230 V AC	3RS10 10-1CK10
0...+200 °C		24 V AC/DC	3RS10 10-1CD20	
	110/230 V AC	3RS10 10-1CK20		
Typ J (thermoelement)	Overrange	0...+200 °C	24 V AC/DC	3RS11 00-□CD20
			110/230 V AC	3RS11 00-1CK20
		0...+600 °C	24 V AC/DC	3RS11 00-1CD30
			110/230 V AC	3RS11 00-1CK30
Typ K (thermoelement)	Overrange	0...+200 °C	24 V AC/DC	3RS11 01-□CD20
			110/230 V AC	3RS11 01-1CK20
		0...+600 °C	24 V AC/DC	3RS11 01-1CD30
			110/230 V AC	3RS11 01-1CK30
		+500...+1000 °C	24 V AC/DC	3RS11 01-1CD40
			110/230 V AC	3RS11 01-1CK40
<b>Analog adjustable for alarm and trip (2 threshold values), 22.5 mm wide; open-circuit – closed-circuit current principle can be toggled between; no holding on supply failure function; 1 NO + 1 CO</b>				
PT100 (resistance sensor)	Overrange	–50...+50 °C	24 V AC/DC	3RS10 20-1DD00
			24–240 V AC/DC	3RS10 20-1DW00
		0...+100 °C	24 V AC/DC	3RS10 20-1DD10
			24–240 V AC/DC	3RS10 20-1DW10
		0...+200 °C	24 V AC/DC	3RS10 20-1DD20
	24–240 V AC/DC		3RS10 20-□DW20	
	Underrange	–50...+50 °C	24 V AC/DC	3RS10 30-1DD00
			24–240 V AC/DC	3RS10 30-1DW00
		0...+100 °C	24 V AC/DC	3RS10 30-1DD10
			24–240 V AC/DC	3RS10 30-1DW10
0...+ 200 °C		24 V AC/DC	3RS10 30-□DD20	
	24–240 V AC/DC	3RS10 30-1DW20		
Typ J (thermoelement)	Overrange	0...+200 °C	24 V AC/DC	3RS11 20-□DD20
			24–240 V AC/DC	3RS11 20-1DW20
		0...+600 °C	24 V AC/DC	3RS11 20-1DD30
			24–240 V AC/DC	3RS11 20-1DW30
Typ K (thermoelement)	Overrange	0...+200 °C	24–240 V AC/DC	3RS11 21-1DW20
			24–240 V AC/DC	3RS11 21-1DW30
		0...+600 °C	24 V AC/DC	3RS11 21-1DD40
			24–240 V AC/DC	3RS11 21-1DW40

Analog adjustable evaluation devices with one and two threshold values. For analog adjustable devices, the threshold values and the hysteresis from 2 to 20% are set using a rotary potentiometer. For devices with 2 threshold values, the selectable hysteresis only acts

on threshold value 1. For the second threshold value, the hysteresis is permanently set to 5%. This series of products was developed for applications where a setting accuracy of  $\pm 5\%$  is sufficient.

# 3RS10/3RS11 and 3RS20/3RS21 Temperature Monitoring Relays

## Digitally adjustable relays

These relays are used to measure temperatures in solid, liquid and gaseous mediums. They monitor temperatures to evaluate whether they lie within a specific operating range (window function). Our 3RS10 40 and 3RS11 40 relays are in compliance with DIN 3440 as temperature monitor; the 3RS10 42 and 3RS11 42 relays can be used, in accordance with DIN 3440, as temperature limiting devices. These represent a good alternative to temperature controllers in the low-end sector.



### Your advantages:

- Simple to operate without complex menu prompting
- Certified according to DIN 3440
- 2- or 3-conductor resistance sensors can be connected
- Versions available in °Fahrenheit
- All versions have removable terminals
- All versions with either screw terminals or with spring-loaded terminals

### Applications:

- Protecting equipment and the environment
- Temperature monitoring for process quantities – e.g. in the packaging industry or galvanizing systems
- Temperature monitoring for heating systems
- Monitoring exhaust gas temperatures
- HVAC systems, solar collectors, heat pumps or warm water supplies
- Monitoring motor, bearing and gearbox oil temperatures
- Cooling liquids temperature monitoring

### Characteristics of the most important resistance temperature sensors

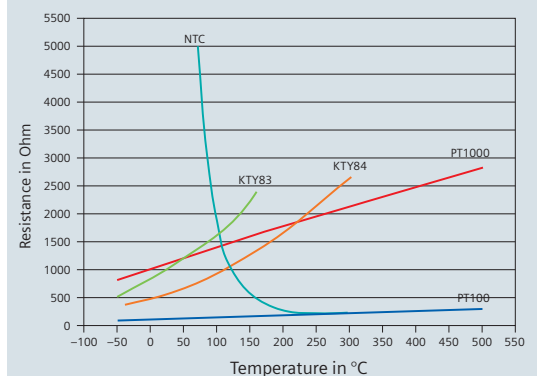

## 3RS10/3RS11 Temperature Monitoring Relays

Sensor	Measuring range (measuring range limit depends on the sensor)	Rated control supply voltage $V_S$ 50–60 Hz AC	Order No.
<b>"Temperature monitor" acc. to DIN 3440, digitally adjustable, 2 threshold values, 45 mm wide; 1 CO + 1 CO + 1 NO, memory function can be enabled using an external jumper. Relay parameters have a holding on supply failure function</b>			
PT100/1000; KTY83/84; NTC (resistance sensor) <sup>1)</sup>	–50...+500 °C	24 V AC/DC 24–240 V AC/DC	3RS10 40-□GD50 3RS10 40-□GW50
	–50...+932 °F	24 V AC/DC 24–240 V AC/DC	3RS20 40-□GD50 3RS20 40-□GW50
TYPE J, K, T, E, N (thermoelement)	–99...+999 °C	24 V AC/DC 24–240 V AC/DC	3RS11 40-□GD60 3RS11 40-□GW60
	–99...+1830 °F	24 V AC/DC 24–240 V AC/DC	3RS21 40-□GD60 3RS21 40-□GW60
<b>"Temperature limiter" and "temperature monitor" acc. to DIN 3440, digitally adjustable, 2 threshold values, 45 mm wide; 1 CO + 1 CO + 1 NO, tripped state and relay parameters are saved using a holding on supply failure function</b>			
PT100/1000; KTY83/84; NTC (resistance sensor) <sup>1)</sup>	–50...+750 °C	24 V AC/DC 24–240 V AC/DC	3RS10 42-□GD70 3RS10 42-□GW70
	–99...+1800 °C	24 V AC/DC 24–240 V AC/DC	3RS11 42-□GD80 3RS11 42-□GW80

## Motor monitoring relays, digitally adjustable for up to 3 sensors, 45 mm wide; 1 CO + 1 CO + 1 NO

Sensor	No of sensors	Measuring range	Rated control supply voltage $V_S$	Order No.
PT100/1000; KTY83/84; NTC (resistance sensor) <sup>1)</sup>	1 to 3 sensors	–50...+500 °C	24–240 V AC/DC	3RS10 41-□GW50
		–50...+932 °F	24–240 V AC/DC	3RS20 41-□GW50

<sup>1)</sup> NTC type: B57227-K333-A1 (100 °C: 1.8 kΩ; 25 °C: 32.762 kΩ)

Screw terminal **1**  
Spring-loaded terminal **2**

The short-circuit and wire breakage detection, as well as the measuring range are restricted, depending on the sensor type:

## Measuring ranges in °C for thermoelements

Sensor type	Short circuit	Wire breakage	3RS11 40 measuring range	3RS11 42 measuring range
J	–	x	–99...999	–99...1200
K	–	x	–99...999	–99...1350
T	–	x	–99...400	–99...400
E	–	x	–99...999	–99...999
N	–	x	–99...999	–99...999
S	–	x	–	0...1750
R	–	x	–	0...1750
B	–	x	–	400...1800

## Measuring ranges in °C for resistance sensors

Sensor type	Short circuit	Wire breakage	3RS10 40 measuring range	3RS10 42 measuring range
PT100	x	x	–50...500	–50...750
PT1000	x	x	–50...500	–50...500
KTY83-110	x	x	–50...175	–50...175
KTY84	x	x	–40...300	–40...300
NTC <sup>1)</sup>	x	–	80...160	80...160

<sup>1)</sup> NTC type: B57227-K333-A1 (100 °C: 1.8 kΩ; 25 °C: 32.762 kΩ)

## Digitally adjustable evaluation units

Temperature monitoring relays distinguish themselves due to the fact that they are extremely easy to operate. The actual temperature is always displayed on the three-digit LED display. A dedicated relay with one NO contact is integrated to monitor the sensor. The relay is switched-off in the parameterizing mode.

The following parameters can be set:

- Sensor type
- 2 threshold values  $J_1, J_2$
- 1 hysteresis; this acts on both thresholds (0–99 K)
- 1 delay time; this acts on both thresholds (0–999 s)
- Either the open-circuit/closed-circuit principle can be selected
- Function: Overtemperature/Undertemperature (overrange/underrange) or window monitoring within a defined range

Versions with a wide-range voltage have electrical isolation.

The temperature ranges are dependant on the sensor type (refer to the function).

Under [www.siemens.com/temperature](http://www.siemens.com/temperature), you will find the right sensor.

# Coupling Relays – Narrow Design

## 3TX70 Relay Couplers

**3TX70 relay couplers are available in two basic versions. The 3TX7004/05 is only 6.2 mm wide: taking up a lot less space in the electrical cabinet. Then there is the 3TX7002/03 series: These devices are suitable for mounting in small electrical cabinets with a low depth and short distances between the mounting rails. Both series are available with an extensive range of input and output couplers.**

### Your advantages: 3TX7002/03 and 3TX7004/05

- Operating range from 0.7 to 1.25 V<sub>S</sub> at 24 V DC up to 60 °C
- Protective circuit is integrated in the input
- Connection comb and cable to connect voltages at the same potential
- Manual-0-automatic switch for easier commissioning

### Your advantages: 3TX7014 and 3TX7015

- Plug-in relays that can be quickly replaced with preassembled wiring
- Conductors are introduced and clamped from the front – therefore shorter wiring times
- Tested, complete devices reduce installation times
- Individual relays are available as spare parts
- Relay version with hard-gold-plated contacts – therefore achieving a high contact reliability

### Applications:

- Electrical isolation
- Voltage conversion – e.g. from 24 V DC to 230 V AC
- Signal amplification
- Contact multiplication
- General relay controls
- Overvoltage and EMC protection of controls

### Engineering information:

When selecting the interface for rated control supply voltages of 110 V AC and 230 V AC, the maximum permissible cable length must be carefully observed. The special 3TX700-...05 relay can be used for longer cables.

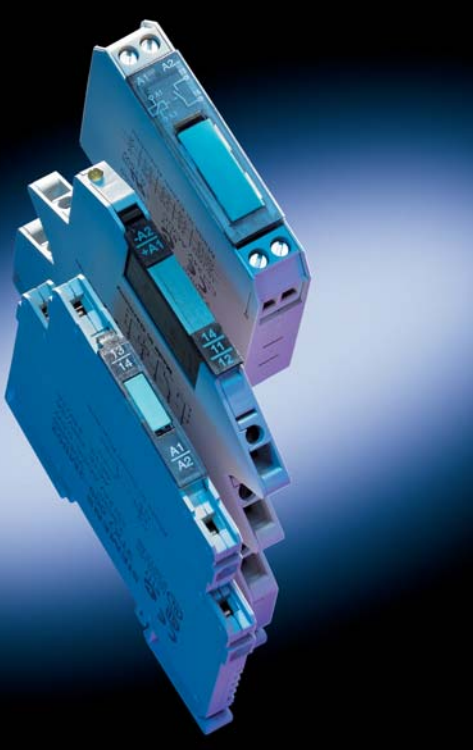

### Coupling relays as input or output coupler

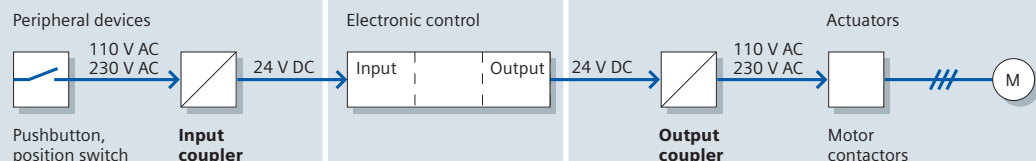



### 3TX701 relay couplers, plug-in

#### Plug-in socket couplers, complete with relay

Contact	Rated control supply voltage $V_s$	Width	Hard-gold-plated	M-0-A switch	Order No.
1 NO	24 V DC	6.2 mm	–	–	3TX701□-1AM00
1 CO	24 V DC	6.2 mm	–	–	3TX701□-1BM00
	24 V AC/DC	6.2 mm	–	–	3TX701□-1BB00
	115 V AC/DC	6.2 mm	–	–	3TX701□-1BE00
	230 V AC/DC	6.2 mm	–	–	3TX701□-1BF00

#### Plug-in socket couplers, complete with relay and hard-gold-plated contacts

1 CO	24 V DC	6.2 mm	yes	–	3TX701□-1BM02
	24 V AC/DC	6.2 mm	yes	–	3TX701□-1BB02
	115 V AC/DC	6.2 mm	yes	–	3TX701□-1BE02
	230 V AC/DC	6.2 mm	yes	–	3TX701□-1BF02

#### Accessories

Connecting comb, 16-pin	3TX7014-7AA00
Potential isolation plate	3TX7014-7CE00

Screw terminal **4**

Spring-loaded terminal **5**

### 3TX700 relay couplers, not pluggable

#### 3TX7004/05 – output couplers with relay output

Contact	Rated control supply voltage	Width	Hard-gold-plated	M-0-A switch	Order No.
1 CO	24 V AC/DC	6.2 mm	–	–	3TX700□-1LB00
			yes	–	3TX700□-1LB02
	230 V AC/DC	12.5 mm	–	yes	3TX700 <b>4</b> -1BB10
			–	–	3TX700□-1LF00
1 NO	24 V AC/DC	6.2 mm	–	–	3TX700□-1MB00
			–	–	3TX700 <b>4</b> -1BF05 <sup>1)</sup>
			–	–	3TX700□-1MF00
1 NO	230 V AC/DC	6.2 mm	yes	–	3TX700□-2MF02
			yes	–	3TX700 <b>4</b> -2ME02
			yes	–	3TX700□-2MB02

#### 3TX7004/05 – input couplers with relay output

1 NO	230 V AC/DC	6.2 mm	yes	–	3TX700□-2MF02
	110 V AC/DC	6.2 mm	yes	–	3TX700 <b>4</b> -2ME02
	24 V AC/DC	6.2 mm	yes	–	3TX700□-2MB02

Screw terminal **4**

Spring-loaded terminal **5**

#### 3TX7002/03 – for low heights between tiers – output couplers with relay output

Output	Voltage	Width	Hard-gold-plated	Order No.
1 NO	24 V AC/DC	11.5 mm	–	3TX700□-1AB00
		11.5 mm	yes	3TX700□-1AB02
1 CO	24 V AC/DC	17.5 mm	–	3TX700□-1BB00
	230 V AC/DC	17.5 mm	–	3TX7002-1BF00
2 NO	24 V AC/DC	22.5 mm	–	3TX700□-1CB00
2 CO	24 V AC/DC	22.5 mm	yes	3TX700□-1FB02

#### 3TX7002/03 – input couplers with relay output

1 NO	230 V AC/DC	11.5 mm	–	3TX700□-2AF00
	230 V AC/DC	11.5 mm	–	3TX7002-2AF05
	110 V AC/DC	11.5 mm	–	3TX7002-2AE00
	24 V AC/DC	11.5 mm	–	3TX7002-2AB00
1 CO	230 V AC/DC	17.5 mm	yes	3TX7002-2BF02

#### Accessories

Connecting cable with 24 connecting points for 3TX70	3TX7004-8BA00
Connecting comb with 24 connecting points for 3TX7004, 6.2 mm wide	3TX7004-8AA00

<sup>1)</sup> For longer cables up to 350 m

Screw terminal **2**

Spring-loaded terminal **3**

# Coupling Relays – Narrow Design

## 3TX70 Semiconductor Couplers

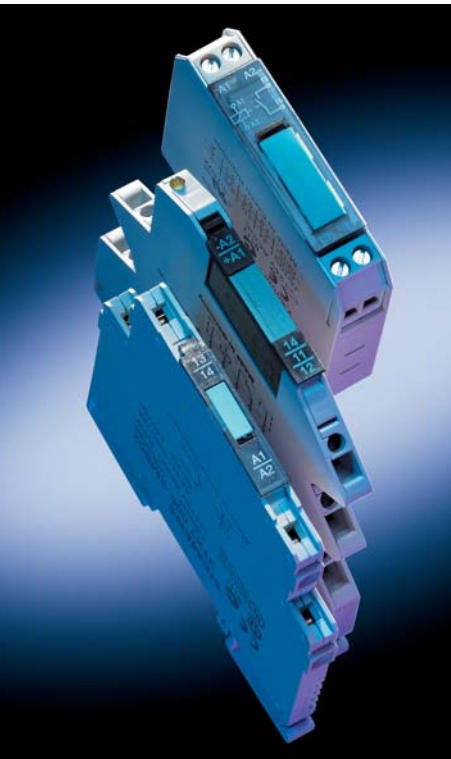

Coupling modules are available either with relays or semiconductors. Semiconductor couplers offer some significant advantages: The electronic components are extremely reliable and have a very long service life (refer to the diagram below). The input coupler combines the best of both worlds – improved technical features and a lower price. When considering output couplers, the question of “relay or semiconductor” needs to be taken into account as well as the making/breaking capacity and the number of operating cycles. If a relay has to be replaced just once during the complete lifetime of a machine, then a semiconductor coupler will have paid for itself.

### Your advantages:

- Reliable input couplers with semiconductor output
- Graduated series of output couplers with semiconductors
- Extremely long electrical life
- Extremely high contact reliability
- High DC making/breaking capacity
- Short switching times

### Applications:

- Providing electrical isolation, converting voltages
- Switching DC loads
- Switching capacity loads
- High number of switching cycles
- Overvoltage and EMC protection of controls

### Use of semiconductor couplers

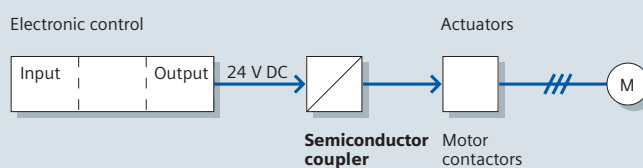

### Comparison of lifetimes

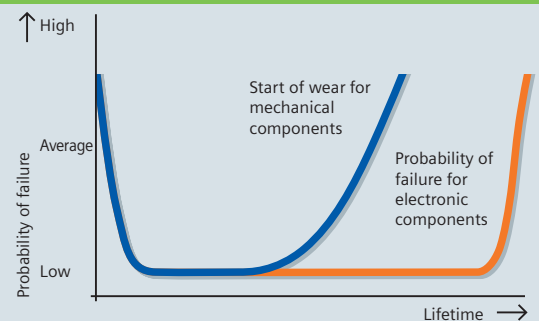

Electronic coupling modules have a significantly higher lifetime than electromechanical devices.

### 3TX70 Semiconductor Couplers

#### 3TX7004/05 – the narrow space saver – output couplers with semiconductor output, 1 NO contact

Control supply voltage	Width	Max. switching current	Switching voltage	Min. load current	Short-time load capacity	M-0-A switch	Order No.
24 V DC	6.2 mm	0.5 A	≤ 48 V DC	–	1.5 A/20 ms	–	3TX700□-3AB04
	6.2 mm	1.5 A	≤ 30 V DC	–	Short-circuit-proof	–	3TX700□-3PB54
	6.2 mm	3 A	≤ 30 V DC	–	Short-circuit-proof	–	3TX700□-3PB74
	12.5 mm	5 A	≤ 30 V DC	0.5 A	Short-circuit-proof	–	3TX700□-3AC04
	12.5 mm	5 A	≤ 30 V DC	0.5 A	Short-circuit-proof	yes	3TX700□-3AC14
	12.5 mm	2 A	24–250 V AC	0.05 A	100 A/20 ms	–	3TX700□-3AC03
110–230 V AC	6.2 mm	3 A	≤ 30 V DC	–	Short-circuit-proof	–	3TX700□-3PG74

#### Input couplers with semiconductor output, 1 NO contact

110–230 V AC	6.2 mm	0.1 A	≤ DC 30 V	–	0.2 A/3 ms	–	3TX700□-4PG24
--------------	--------	-------	-----------	---	------------	---	---------------

Screw terminal **4**

Spring-loaded terminal **5**

#### 3TX7002 – for low tier heights – output couplers with semiconductor output, one NO contact

Control supply voltage	Width	Max. switching current	Switching voltage	Min. load current	Short-time load capacity	Order No.
24 V DC	12.5 mm	1.8 A	48–264 V AC	0.06 A	20 A/20 ms	3TX7002-3AB00
24 V DC	11.5 mm	1.5 A	≤ 60 V DC	–	4 A/0.2 ms	3TX7002-3AB01

#### Input couplers with semiconductor output, 1 NO contact

110–230 V AC	12.5 mm	0.1 A	≤ 60 V DC	–	1 A/20 ms	3TX7002-4AG00
24 V AC/DC	12.5 mm	0.1 A	≤ 30 V DC	–	1 A/20 ms	3TX7002-4AB00

#### Accessories

Connecting cable with 24 connecting points for 3TX70 **3TX7004-8BA00**

Connecting comb with 24 connecting points for 3TX7004, 6.2 mm wide **3TX7004-8AA00**



Using the accessories it is easy to insert a jumper between the same voltage levels.

# Coupling Relays with industrial housing

## 3RS18 Relay Couplers

The new 3RS18 relay couplers set standards: They have a wide-range voltage extending from 24 V AC/DC to 240 V. This makes them absolutely unique in the coupling market. All of these devices are built in a well-proven, rugged 22.5 mm wide housing. Relays with 1, 2 and 3 changeover contacts are available in both screw and spring-loaded terminal versions. These relays are also available in combination and wide-range voltage with hard-gold-plated contacts for an especially high contact reliability – even at low current levels. Due to the proven, rugged housing, you can enjoy the benefits of user-friendly connection systems, with removable terminals – just the same as our timing relays. 2 conductors can be connected at each terminal point.

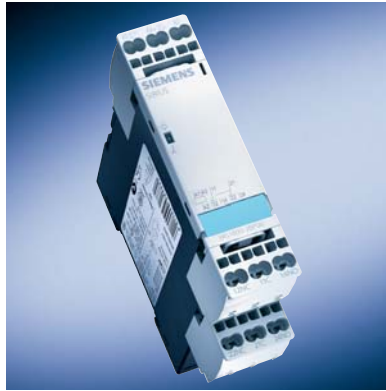

### Your advantages:

- New, worldwide: One device for all voltages
- Lower costs due to fewer versions
- Removable terminals with screw terminals or alternatively with innovative spring-loaded terminals
- Especially high contact reliability even at low currents

### Applications:

- Everywhere that contacts which are electronics-compatible are required and where devices with wide-range voltage are used
- Due to the hard-gold-plated contacts, predestined for PLC I/O

### 3RS18 relay couplers in a rugged, industrial housing 22.5 mm wide

Rated control supply voltage $V_s$	Contact versions	Order No.
<b>50/60 Hz</b> <b>Wide-range voltage</b> 24–240 V AC/DC	2 CO	3RS18 00-□ BW00
	3 CO	3RS18 00-□ HW00
	3 CO hard-gold-plated	3RS18 00-□ HW01
<b>Combination voltage</b> 24 V AC/DC and 110–120 V AC	1 CO	3RS18 00-□ AQ00
	2 CO	3RS18 00-□ BQ00
	3 CO	3RS18 00-□ HQ00
	3 CO hard-gold-plated	3RS18 00-□ HQ01
24 V AC/DC and 220–240 V AC	1 CO	3RS18 00-□ AP00
	2 CO	3RS18 00-□ BP00
	3 CO	3RS18 00-□ HP00
	3 CO hard-gold-plated	3RS18 00-□ HP01

Screw terminal **1**  
Spring-loaded terminal **2**



# LZX/LZS Plug-In Relays

## Complete devices and single modules

LZX/LZS plug-in relays are available either as complete devices or as individual modules. The individual modules can then be assembled or used as spare parts. This range is subdivided into three designs: LZX/LZS:RT, LZX/LZS:PT and LZX/LZS:MT.

### Your advantages:

- All designs with tried-and-tested screw-terminals or push in spring-loaded terminals
- Wiring without tools and vibration-proof connection due to innovative push-in spring-loaded terminals
- Socket with logical separation for ease of wiring
- Tested AC-15 and DC-13 switching capacity
- Available coil voltages: 24 V DC, 24 V AC, 115 V AC, 230 V AC
- Hard-gold-plated contacts for optimum interaction with electronic controls

### Applications:

- As coupling relay to couple inputs and outputs for electronic controls
- Multiplying contacts
- Switching small loads
- As measured value changeover switch



### Engineering information:

The lever of the LZX:PT relays does not feature a latching mechanism. If the level is pressed further until a movement of 90° is reached, two small lugs break off and the test lever can be set to latching.

When using LZX relays with voltages of 60 Hz AC, the lower response value must be increased by 10% as the power loss slightly decreases.

Switching capacity of the plug-in relays	AC-15, 230 V	DC-13, 24 V
LZX:RT 1 CO (changeover contact)	6 A	2 A
LZX:RT 2 CO	3 A	2 A
LZX:PT 2 CO	5 A	5 A
LZX:PT 3 CO	5 A	5 A
LZX:PT 4 CO	4 A	5 A
LZX:MT 3 CO	5 A	2 A

### Designs

#### LZX/LZS:RT

1 or 2 CO contacts  
AC-1: 16/8 A  
width: 15.5 mm



#### LZX/LZS:PT

2, 3 or 4 CO contacts  
AC-1: 12/10/6 A  
width: 28 mm



#### LZX/LZS:MT

3 CO contacts  
AC-1: 10 A  
width: 38 mm



## Relay couplers – LZS complete modules (socket, relay, hold/eject clip, LED module and inscription plate)

Design	Rated control supply voltage $U_s$	Contacts	Width in mm	Order No.
<b>Complete devices, 11- and 14-pole, PT range</b>				
<b>Complete device with plug-in socket (screw terminal, standard)</b> for snapping onto 35 mm mounting rail, consisting of: plug-in relay, plug-in socket standard with screw terminal, LED module (24 V DC LED module with free-wheeling diode, AC without free-wheeling diode), hold/eject clip and inscription plate	24 V DC	3 CO	28	LZS:PT3A5L24
	24 V AC			LZS:PT3A5R24
	115 V AC			LZS:PT3A5S15
	230 V AC			LZS:PT3A5T30
	24 V DC	4 CO	28	LZS:PT5A5L24
	24 V AC			LZS:PT5A5R24
	115 V AC			LZS:PT5A5S15
<b>Complete device with plug-in socket (screw terminal, logical separation)</b> for snapping onto 35 mm mounting rail, consisting of: plug-in relay, plug-in socket with screw terminal and logical separation, LED module (24 V DC LED module with free-wheeling diode, AC without free-wheeling diode), hold/eject clip and inscription plate	24 V DC	4 CO	28	LZS:PT5B5L24
	24 V AC			LZS:PT5B5R24
	115 V AC			LZS:PT5B5S15
	230 V AC			LZS:PT5B5T30
<b>Complete device with plug-in socket (spring-loaded terminal, logical separation)</b> <b>NEW!</b> for snapping onto 35 mm mounting rail, consisting of: plug-in relay, plug-in socket with spring-loaded terminal and logical separation, LED module (24 V DC LED module with free-wheeling diode, AC without free-wheeling diode), hold/eject clip and inscription plate	24 V DC	4 CO	28	LZS:PT5D5L24
	24 V AC			LZS:PT5D5R24
	115 V AC			LZS:PT5D5S15
	230 V AC			LZS:PT5D5T30
<b>Complete devices, 8-pole, 5 mm pinning, RT range</b>				
<b>Complete device with plug-in socket (screw terminal, standard)</b> for snapping onto 35 mm mounting rail, consisting of: print relay, plug-in socket standard with screw terminal, LED module (24 V DC LED module with free-wheeling diode, AC without free-wheeling diode), hold/eject clip and inscription plate	24 V DC	1 CO	15.5	LZS:RT3A4L24
	24 V DC	2 CO		LZS:RT4A4L24
	230 V AC	1 CO		LZS:RT3A4T30
	230 V AC	2 CO		LZS:RT4A4T30
	24 V AC	1 CO	15.5	LZS:RT3A4R24
	24 V AC	2 CO		LZS:RT4A4R24
	115 V AC	1 CO		LZS:RT3A4S15
<b>Complete device with plug-in socket (screw terminal, logical separation)</b> for snapping onto 35 mm mounting rail, consisting of: print relay with safe isolation, plug-in socket with screw terminal and logical separation, LED module (24 V DC LED module with free-wheeling diode, AC without free-wheeling diode), hold/eject clip and inscription plate	24 V DC	1 CO	15.5	LZS:RT3B4L24
	24 V DC	2 CO		LZS:RT4B4L24
	230 V AC	1 CO		LZS:RT3B4T30
	230 V AC	2 CO		LZS:RT4B4T30
	24 V AC	1 CO	15.5	LZS:RT3B4R24
	24 V AC	2 CO		LZS:RT4B4R24
	115 V AC	1 CO		LZS:RT3B4S15
<b>Complete device with plug-in socket (spring-loaded terminal, logical separation)</b> <b>NEW!</b> for snapping onto 35 mm mounting rail, consisting of: print relay, plug-in socket with spring-loaded terminal and logical separation, LED module (24 V DC LED module with free-wheeling diode, AC without free-wheeling diode), hold/eject clip and inscription plate	24 V DC	1 CO	15.5	LZS:RT3D4L24
	24 V DC	2 CO		LZS:RT4D4L24
	230 V AC	1 CO		LZS:RT3D4T30
	230 V AC	2 CO		LZS:RT4D4T30
	24 V AC	1 CO	15.5	LZS:RT3D4R24
	24 V AC	2 CO		LZS:RT4D4R24
	115 V AC	1 CO		LZS:RT3D4S15
115 V AC	2 CO		LZS:RT4D4S15	

### Logical separation:

The connections of the contacts and the connections of the coil are arranged on different sides, e.g. contacts at the top and coils at the bottom. This allows for a clearer wiring arrangement. The logical separation is not necessarily a safe isolation.

### Safe isolation:

The safe isolation is the isolation which prevents the passover of a circuit's voltage to another circuit with sufficient safety (DIN VDE 106 Part 101).

## Relay couplers – single modules for self-assembly

### RT range

#### Print relays

Control supply voltage	Contacts	LED	Free-wheeling diode	Logical separation	Hard-gold-plating	Order No.
24 V DC	1 CO	–	–	–	–	LZX:RT314024
24 V DC	2 CO	–	–	–	–	LZX:RT424024
24 V AC	1 CO	–	–	–	–	LZX:RT314524
24 V AC	2 CO	–	–	–	–	LZX:RT424524
115 V AC	1 CO	–	–	–	–	LZX:RT314615
115 V AC	2 CO	–	–	–	–	LZX:RT424615
230 V AC	1 CO	–	–	–	–	LZX:RT314730
230 V AC	2 CO	–	–	–	–	LZX:RT424730
24 V DC	1 CO	–	–	–	yes	LZX:RT315024
24 V AC	1 CO	–	–	–	yes	LZX:RT315524
230 V AC	1 CO	–	–	–	yes	LZX:RT315730

**Accessories, suitable for 1 and 2 CO**

NEW! Plug-in socket with screw terminal for snapping onto mounting rail	no logical separation (standard)	LZS:RT78725
	with logical separation	LZS:RT78726
NEW! Plug-in socket with spring-loaded terminal for snapping onto mounting rail	with logical separation	LZS:RT7872P
	–	LZS:RT17016
Hold/eject clip for screw-terminal and spring-loaded terminal socket	–	LZS:RT17040
Inscription plate	–	LZS:RT17040

**PT range**

**Plug-in relays**

Control supply voltage	Contacts	LED	Free-wheeling diode	Hard-gold-plating	Test lever	Order No.
24 V DC	2 CO	–	–	–	yes	LZX:PT270024
24 V DC	3 CO	–	–	–	yes	LZX:PT370024
24 V DC	4 CO	–	–	–	yes	LZX:PT570024
24 V DC	4 W	–	–	–	–	LZX:PT520024
24 V DC	4 CO	–	–	yes	yes	LZX:PT580024
24 V AC	2 CO	–	–	–	yes	LZX:PT270524
24 V AC	3 CO	–	–	–	yes	LZX:PT370524
24 V AC	4 CO	–	–	–	yes	LZX:PT570524
115 V AC	2 CO	–	–	–	yes	LZX:PT270615
115 V AC	3 CO	–	–	–	yes	LZX:PT370615
115 V AC	4 CO	–	–	–	yes	LZX:PT570615
230 V AC	2 CO	–	–	–	yes	LZX:PT270730
230 V AC	3 CO	–	–	–	yes	LZX:PT370730
230 V AC	4 CO	–	–	–	yes	LZX:PT570730
230 V AC	4 CO	–	–	yes	yes	LZX:PT580730
230 V AC	4 CO	–	–	–	–	LZX:PT520730

**Accessories**

NEW! Plug-in socket with screw terminal for snapping onto mounting rail	2 CO	no logical separation	LZS:PT78720
	3 CO		LZS:PT78730
	4 CO		LZS:PT78740
	2 CO		with logical separation
4 CO	LZS:PT78742		
NEW! Plug-in socket with spring-loaded terminal for snapping onto mounting rail	2 CO	with logical separation	LZS:PT7872P
	4 CO		LZS:PT7874P
Hold/eject clip for screw-terminal and spring-loaded terminal socket	2/3/4 CO	with logical separation	LZS:PT17021
Hold/eject clip for screw-terminal socket	2/3/4 CO	no logical separation	LZS:PT17024
Inscription plate	–	–	LZS:PT17040

**Accessories for the RT and PT range**

LED module red	Control supply voltage	24 V DC	Free-wheeling diode	LZS:PTML0024
LED module red		24 V AC/DC	–	LZS:PTML0524
		110–230 V AC	–	LZS:PTML0730
		24 V DC	Free-wheeling diode	LZS:PTMG0024
LED module green		24 V AC/DC	–	LZS:PTMG0524
		110–230 V AC	–	LZS:PTMG0730
		6–230 V DC	Free-wheeling diode	LZS:PTMT00A0
Free-wheeling diode		24–48 V AC	–	LZS:PTMU0524
RC element		110–230 V AC	–	LZS:PTMU0730

**MT Range**

**Plug-in relays**

Control supply voltage	Contacts	LED	Free-wheeling diode	Order No.
24 V DC	3 CO	–	–	LZX:MT321024
24 V DC	3 CO	yes	–	LZX:MT323024
24 V AC	3 CO	–	–	LZX:MT326024
24 V AC	3 CO	yes	–	LZX:MT328024
115 V AC	3 CO	–	–	LZX:MT326115
115 V AC	3 CO	yes	–	LZX:MT328115
230 V AC	3 CO	–	–	LZX:MT326230
230 V AC	3 CO	yes	–	LZX:MT328230

**Accessories**

Plug-in socket with screw terminal for snapping onto mounting rail, 11-pole	LZS:MT78750
Hold clip	LZS:MT28800

# 3RS17 Interface Converters

## Normalized signal and universal converters



Interface converters are mainly used to electrically isolate and convert analog signals. Sensors/actuators and controls generally have different power supply units, and therefore require electrical isolation in the signal circuit. This is either integrated in the control or is implemented using an interface converter.

A signal must be converted into another signal if, for instance, a voltage signal needs to be transmitted over a long distance as current signal – or if the output of a sensor and the input of a control system are not compatible with one another.

Frequency outputs can be used for an additional application. In this case, the input signal is converted into a proportional frequency. This means that analog signals can be processed with digital inputs. This is important if the control does not have provision for an analog input or if all of its analog inputs are already assigned. This can occur, for example, when devices are retrofitted.

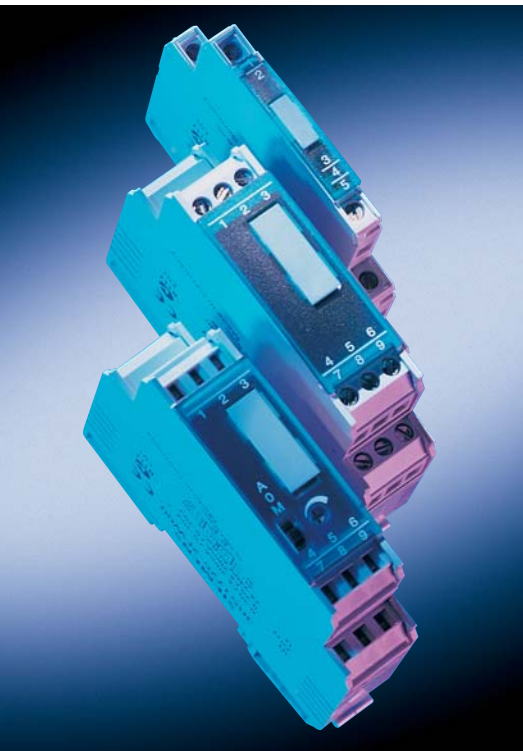

### Your advantages:

- Space-saving design
- Easy-to-set universal converter
- Converters with frequency output
- All ranges are fully calibrated
- Unified family of devices – the ideal solution for every application
- Integrated manual-automatic switch with adjustable setpoint
- Outputs are short-circuit-proof
- Up to 30 V – protected against damage caused by faulty wiring

### Applications:

- Electrically isolating analog signals
- Converting analog signals
- Converting analog signals into a frequency
- Converting non-normalized into normalized signals
- Overvoltage protection for analog inputs

### Engineering information:

Passive converters draw the power they require from the analog signal. They do not require their own power supply.

For 2-way isolation, the input is electrically isolated from the output and from the power supply, output and power supply are at the same potential. For 3-way isolation, all of the three circuits are isolated from one another.

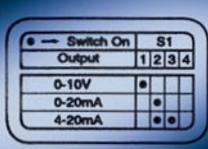

**3RS17 Interface Converters**

Input	Output	Width	H-A switch	Control supply voltage	Electrical isolation	Order No.
0-10 V	0-10 V	6.2 mm	-	24 V AC/DC	2-way	<b>3RS1700-□AD00</b>
0-10 V	0-20 mA	6.2 mm	-	24 V AC/DC	2-way	<b>3RS1700-□CD00</b>
0-10 V	4-20 mA	6.2 mm	-	24 V AC/DC	2-way	<b>3RS1700-□DD00</b>
0-20 mA	0-10 V	6.2 mm	-	24 V AC/DC	2-way	<b>3RS1702-□AD00</b>
0-20 mA	0-20 mA	6.2 mm	-	24 V AC/DC	2-way	<b>3RS1702-□CD00</b>
0-20 mA	4-20 mA	6.2 mm	-	24 V AC/DC	2-way	<b>3RS1702-□DD00</b>
4-20 mA	0-10 V	6.2 mm	-	24 V AC/DC	2-way	<b>3RS1703-□AD00</b>
4-20 mA	0-20 mA	6.2 mm	-	24 V AC/DC	2-way	<b>3RS1703-□CD00</b>
4-20 mA	4-20 mA	6.2 mm	-	24 V AC/DC	2-way	<b>3RS1703-□DD00</b>
0-20 mA	0-20 mA	6.2 mm	-	Passive converter	2-way	<b>3RS1720-□ET00</b>
0-20 mA	0-20 mA	12.5 mm	-	Passive converter	2-way	<b>3RS1721-□ET00</b>
2 x 0-20 mA	2 x 0-20 mA	12.5 mm	-	Passive converter	2-way	<b>3RS1722-□ET00</b>

**Selectable standard interface converter**

0-10 V 0/4-20 mA selectable	0-10 V 0/4-20 mA selectable	6.2 mm	-	24 V AC/DC	2-way	<b>3RS1705-□FD00</b>
		17.5 mm	-	24-240 V AC/DC	3-way	<b>3RS1705-□FW00</b>
0-10 V 0/4-20 mA selectable	0-10 V 0/4-20 mA selectable	17.5 mm	yes	24 V AC/DC	2-way	<b>3RS1725-□FD00</b>
		17.5 mm	yes	24-240 V AC/DC	3-way	<b>3RS1725-□FW00</b>
0-10 V 0/4-20 mA selectable	0-50 Hz 0-100 Hz 0-1 kHz 0-10 Hz selectable	6.2 mm	-	24 V AC/DC	2-way	<b>3RS1705-□KD00</b>
		17.5 mm	-	24-240 V AC/DC	3-way	<b>3RS1705-□KW00</b>

**Universal converters**

0-60 mV 0-100 mV 0-300 mV 0-500 mV 0-1 V 0-2 V 0-5 V 0-10 V 0-20 V 2-10 V 0-5 mA 0-10 mA 0-20 mA 4-20 mA ± 5 mA ± 20 mA	0-10 V 0/4-20 mA selectable	17.5 mm	-	24 V AC/DC	2-way	<b>3RS1706-□FD00</b>
				24 V AC/DC	3-way	<b>3RS1706-□FE00</b>
				24-240 V AC/DC	3-way	<b>3RS1706-□FW00</b>

Screw terminal **1**  
Spring-loaded terminal **2**



# 3TG10 Power Relays and SITOP Power Supplies

Wherever small, low-noise relays or contactors are required, the 3TG10 power relays come through with flying colors. At a low cost, these power relays are suitable for basic controls, and especially for use in large series equipment and control systems. They are ideal for applications which only need an auxiliary contact and not an overload relay – yet at the same time demand a higher making/breaking capacity, additional switching voltage and a longer lifetime.

## Your advantages:

- Can be mounted in any position, hum-free
- Protective separation
- Can be screwed or inserted
- Integrated auxiliary contact
- AC-3 power: 4 kW/400 V
- Operating current  $I_e$ /AC-1: 20 A/400 V
- Inrush current per phase: 90 A
- Integrated overvoltage damping
- Slimline design, only 36 mm wide

## Applications:

- Domestic appliances and installations
- Hoisting systems: Small elevators, elevating platforms
- Building services, hum-free devices in building systems, e.g. in hospitals

## Engineering information:

When the three main current paths conduct 20 A, for  $I > 10$  A for the fourth current path: Permissible ambient temperature is 40 °C.



3TG10 Power Relays

AC-1 operating current $I_e$ at 400 V (A)	AC-1 power of three-phase loads at 50 Hz 400 V (kW)	AC-2 and AC-3 operating current at 400 V (A)	AC-2 and AC-3 three-phase loads at 50 Hz 400 V (kW)	Connection type	Contacts	Control supply voltage	Order No.
20	13	8.4	4	Screw terminal	4 NO	230 V AC	3TG1010-0AL2
						110 V AC	3TG1010-0AG2
						24 V AC	3TG1010-0AC2
						24 V DC	3TG1010-0BB4
20	13	8.4	4	Screw terminal	3 NO + 1 NC	230 V AC	3TG1001-0AL2
						110 V AC	3TG1001-0AG2
						24 V AC	3TG1001-0AC2
						24 V DC	3TG1001-0BB4
16	10	8.4	4	Flat, spade terminal	4 NO	230 V AC	3TG1010-1AL2
						110 V AC	3TG1010-1AG2
						24 V AC	3TG1010-1AC2
						24 V DC	3TG1010-1BB4
16	10	8.4	4	Flat, spade terminal	3 NO + 1 NC	230 V AC	3TG1001-1AL2
						110 V AC	3TG1001-1AG2
						24 V AC	3TG1001-1AC2
						24 V DC	3TG1001-1BB4

# 6EP1 SITOP Wide-Voltage Power Supply



The primary clocked 6EP1 SITOP wide-voltage range power supplies in a narrow 22.5 mm housing were especially developed as controlgear for standard products if only "non-standard" power supply voltages are available and/or wide operating ranges of the supply voltage must be covered. These devices have a wide input voltage range and a 24 V DC output. This means that you can use standard devices for practically all of the power supply voltages used. The effect: You save costs for special versions and engineering time.

### Your advantages:

- Only 22.5 mm wide
- Wide input voltage range
- Low weight
- High efficiency

### Applications:

- Voltage unit for all voltage ranges
- Voltage unit for wide operating ranges



### Using SITOP as voltage unit

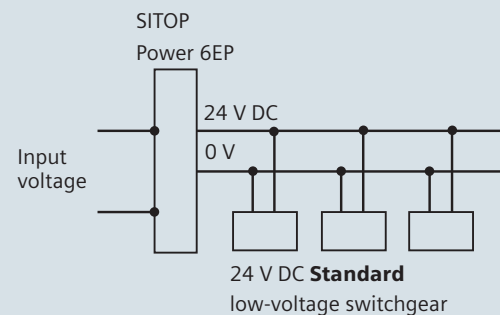

### 6EP1 wide-voltage range power supply for rail mounting

Input voltage	Output voltage	Output current max.	Short-circuit- and overload-proof	Order No.
93–264 V AC	24 V DC	0.5 A	yes	<b>6EP1331-2BA10</b>
30–264 V DC	24 V DC	0.375 A	yes	<b>6EP1731-2BA00</b>
30–187 V AC				

# Ordering by fax +49/911/978-3321 CD/Z1189



SIRIUS Industrial Controls

## Newsletter

Always up-to-date: Our regular Newsletter gives you current information about industrial controls and power distribution. Simply register under [www.siemens.com/lowvoltage/newsletter](http://www.siemens.com/lowvoltage/newsletter)

Please send the selected information to the following address:

Company/Department

Name

Street, Postal Code/City

Telephone/Fax

E-mail

SWITCHING

SIRIUS Solid-state switching devices

STARTING

SIRIUS Infeed system

SIRIUS Engineering load feeders

SIRIUS Soft starter

SIMATIC ET 200pro

SIRIUS Motor starter

MONITORING AND CONTROLLING

SIRIUS Motor management system SIMOCODE pro

SIRIUS Relays

SIRIUS Safety Relays

DETECTING

SIRIUS Position switches

COMMANDING AND SIGNALING

SIRIUS Pushbuttons and indicator lights

SIRIUS Signaling columns and integrated signal lamps

SIRIUS Cable-operated switches

SUPPLYING

SIVENT Fans

SIDAC Reactors & filters

SIDAC & SIVENT Solutions

ENGINEERING

Motor starter

SIMOCODE ES

Soft starter ES

SIRIUS AND MORE

SIRIUS Safety Integrated

AS-Interface

SIRIUS Connection systems

ECOFAST

AS-i News

SIRIUS Modular system

## Siemens AG

Automation and Drives  
Low-Voltage Controls and Distribution  
P.O. Box 48 48, 90327 NUREMBERG, GERMANY

[www.siemens.com/lowvoltage/technical-assistance](http://www.siemens.com/lowvoltage/technical-assistance)  
[www.siemens.com/relays](http://www.siemens.com/relays)

The information provided in this brochure contains merely general descriptions or characteristics of performance which in case of actual use do not always apply as described or which may change as a result of further development of the products. An obligation to provide the respective characteristics shall only exist if expressly agreed in the terms of contract.

All product designations may be trademarks or product names of Siemens AG or supplier companies whose use by third parties for their own purposes could violate the rights of the owners.