



PART No. HN4WM484812GY

for more information visit  
[www.hammfg.com](http://www.hammfg.com)

Data subject to change without notice

Isometric drawing Not to Scale

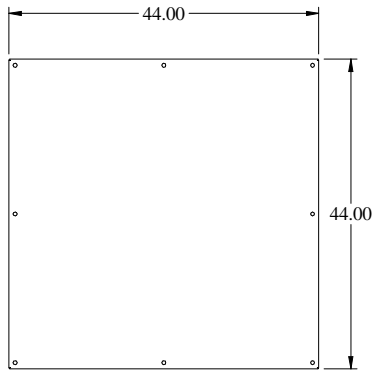
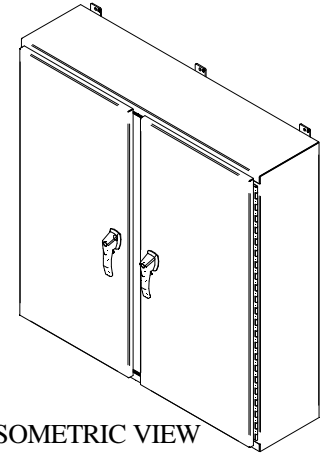

INNER PANEL

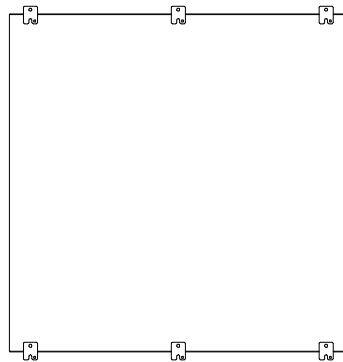

BACK VIEW

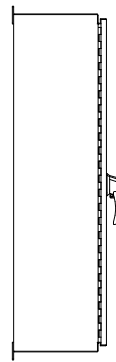

SIDE VIEW

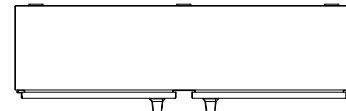

TOP VIEW

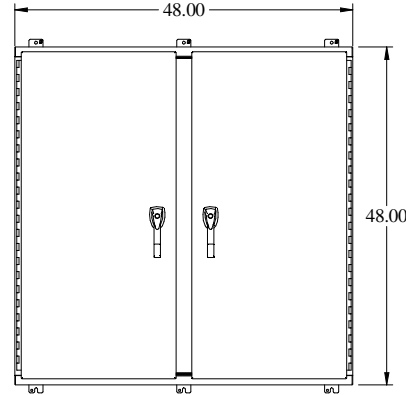

FRONT VIEW

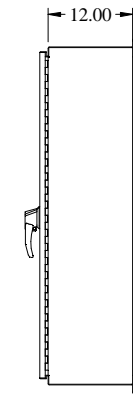

SIDE VIEW

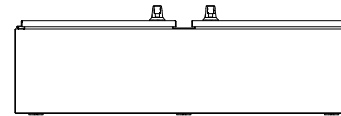

BOTTOM VIEW

ISOMETRIC VIEW