

Double-throw safety switch

Industrial
Light Commercial
Residential
Agricultural

An economical means of transferring power

Shock or P...
ower sources
ore opening cover.
electrically ve
ne "OFF" pos...
efore turning switch "ON."

EATON

Powering Business Worldwide

Double-throw safety switches

Eaton's double-throw safety switches are used to transfer service from a normal power source to an alternate source, or to switch from one load circuit to another. The manually operated double-throw safety switch provides an economical means of transferring power. Eaton offers a full line of general-duty and heavy-duty double-throw safety switches.



General-duty

Eaton's general-duty double-throw safety switches are commonly applied in emergency power or generator applications to reduce or eliminate the costly impact of power loss from the typical source in residential, agricultural and light commercial markets. All general-duty double-throw safety switches are non-fusible and are available up to 400A.

A standby generator connected to a residential wiring system must be installed according to the National Electrical Code.® A double-throw switch must be installed to isolate and disconnect wiring from normal utility lines so that generator-produced electricity is not back-fed onto normal utility lines. Whether normal electrical service is disrupted by severe weather conditions, accidents or other issues, an Eaton general-duty double-throw safety switch is a critical component in your standby generator applications.

Heavy-duty

Eaton's heavy-duty double-throw safety switches are designed for commercial and industrial applications. Fusible switches are available through 600A, while non-fusible switches are manufactured up to 800A. The wiring configuration from the factory allows a single load to be supplied by a normal or alternate source; however, where necessary, the wiring can be field modified to allow two loads to be alternately supplied by a single power source.

Heavy-duty double-throw safety switches are designed to accommodate a wide range of accessories that can be factory or field installed. Customized solutions, including key interlocks, viewing windows and receptacles, are also available through Eaton's Switching Device Flex Center.



Double-throw general-duty non-fusible safety switches

Double-throw, 240 Vac general-duty, non-fusible compact design

Specifications

- 30–100A
- Suitable for service entrance use with neutral kit installed
- Suitable for use as a manually operated switch per 2005 NEC® Article 702
- UL® listed File No. E5239

Features

- Palm-fitting, visible red handle
- Tri-lingual nameplate
- NEMA® 3R enclosure with side opening door
- Visible, embossed ON-OFF indication
- Concentric knockouts on bottom endwall and sides
- Lockable door hasp
- Lockable handle
- Three-point mounting
- Factory-installed neutral (optional catalog numbers are available without a neutral)
- Terminals suitable for 60° or 75°C Al or Cu wire
- Rounded shroud
- Mechanical door interlock to prevent easy access when the switch is in the ON position
- Suitable for use on a circuit capable of delivering not more than 10,000 rms symmetrical amperes
- Compact size

Double-throw, 240 Vac general-duty, non-fusible, quick-make, quick-break design

Specifications

- 30–400A
- Horsepower rated
- Suitable for service entrance use with neutral kit installed
- Suitable for use as a manually operated switch per 2005 NEC Article 702
- UL listed File No. E5239
- Quick-make, quick-break operating mechanism

Features

- Palm-fitting, visible red handle
- Tri-lingual nameplate
- NEMA 3R enclosure with side opening door
- Visible, embossed red ON-OFF indication
- Tangential knockouts (30–100A) on bottom end-wall; concentric knockouts on higher ratings, and sides and rear of 30–100A
- Lockable door hasp
- Lockable handle
- Factory-installed neutral (optional catalog numbers are available without a neutral)
- Three-point mounting (30–100A)
- Four-point mounting (200–400A)
- Terminals suitable for 60° or 75°C Al or Cu wire on 30–100A; 75°C Al or Cu wire on higher ratings
- Rounded shroud

- Door cannot be opened with the switch ON. Switch cannot be turned ON with door open (without operating interlock defeater)
- Suitable for use on a circuit capable of delivering not more than 100,000 rms symmetrical amperes when protected by Class R or J fuses (30–200A); R, T or J fuses (400A). Short-circuit rating is 10,000 rms symmetrical amperes when protected by any other overcurrent protective device
- Double-break visible rotary blades; quick-make, quick-break operation



DT223URH-N
Compact Design, 100A, 240V



DT224URK-NPS
Quick-Make, Quick-Break Design, 200A, 240V.

Double-Throw Compact Design

Ampere Rating Main and Standby	NEMA 3R Enclosure Rainproof	Catalog Number	
Non-Fusible Two-Pole—240 Vac			
30	DT221URH DT222URH DT223URH		Non-Fusible Two-Pole Two Sources or Two Loads
60			
100			
Non-Fusible Two-Pole, Three-Wire—240 Vac—Solid Neutral			
30	DT221URH-N DT222URH-N DT223URH-N		Non-Fusible Two-Pole with Neutral Two Sources or Two Loads
60			
100			

Double-Throw Quick-Make, Quick-Break Design

Ampere Rating Main and Standby	Maximum Horsepower Ratings		NEMA 3R Enclosure Rainproof	Catalog Number	
	240 Vac	250 Vdc			
Non-Fusible Two-Pole—240 Vac—250 Vdc					
30	3	5	DT221URKPS DT222URKPS DT223URKPS DT224URKPS DT225URKPS		Non-Fusible Two-Pole Two Sources or Two Loads
60	10	10			
100	20	20			
200	15	40			
400	—	50			
Non-Fusible Two-Pole, Three-Wire—240 Vac—250 Vdc—Solid Neutral					
30	3	5	DT221URK-NPS DT222URK-NPS DT223URK-NPS DT224URK-NPS DT225URK-NPS		Non-Fusible Two-Pole with Neutral Two Sources or Two Loads
60	10	10			
100	20	20			
200	15	40			
400	—	50			

Double-throw heavy-duty fusible safety switches



DT363FGK
Double-throw Heavy-Duty Fusible Safety Switch, 100A, 600V

Double-throw 240 and 600 Vac heavy-duty, fusible

Specifications

- 30–600A
- Horsepower rated
- Suitable for service entrance use with neutral or ground lug kit installed
- Suitable for use as a manually operated switch per 2005 NEC Article 702
- UL listed File No E5239

Features

- Palm-fitting, visible red handle
- Tri-lingual nameplate
- Side opening doors on all enclosures
- Clear line shield to prevent accidental contact with energized parts; probe holes enable line side testing without removing the shield
- Wiring configuration from factory allows a single load to be supplied by a normal or alternate source; can be modified to allow two loads to be alternately supplied by a single power source
- Visible, embossed red ON-OFF indication
- Tangential knockouts (30–100A) on top and bottom endwall (bottom only on NEMA 3R); concentric knockouts on higher ratings, and sides and rear of 30–100A
- Lockable door hasp
- Lockable handle
- Three-point mounting (30–100A)
- Four-point mounting (200–600A)
- Terminals suitable for 60° or 75°C Al or Cu wire on 30–100A; 75°C Al or Cu wire on higher ratings
- Rounded shroud
- Full range of accessories

Double-Throw 240 Vac Heavy-Duty, Fusible

Ampere Rating Main and Standby	Fuse Class Provision	Maximum Horsepower Ratings with Time-Delay Fuses			NEMA 1 Enclosure Indoor Catalog Number	NEMA 3R Enclosure Rainproof Catalog Number
		Single-Phase 240 Vac	Three-Phase 240 Vac	250 Vdc		
Two-Pole—240 Vac—250 Vdc						
200	H	15	—	40	DT224FGK	DT224FRK
Three-Pole—240 Vac—250 Vdc						
30	H	3	7-1/2	5	DT321FGK	DT321FRK
60	H	10	15	10	DT322FGK	DT322FRK
100	H	15	30	20	DT323FGK	DT323FRK
200	H	15	60	40	DT324FGK	DT324FRK
400	H	—	125	50	DT325FGK	DT325FRK
600	T	—	50	50	DT326FGK	DT326FRK

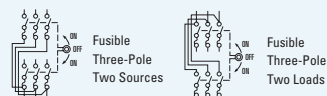
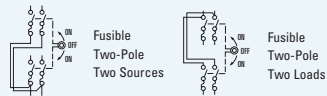

① Only available for use with fast-acting fuses. Standard hp rating is shown.

Double-Throw 600 Vac Heavy-Duty, Fusible

Ampere Rating Main and Standby	Fuse Class Provision	Maximum Horsepower Ratings with Time-Delay Fuses					NEMA 1 Enclosure Indoor Catalog Number	NEMA 3R Enclosure Rainproof Catalog Number	NEMA 4X Enclosure, Corrosion-Resistant Stainless Steel Catalog Number
		480 Vac	600 Vac	480 Vac	600 Vac	250 Vdc			
Three-Pole—600 Vac—250 Vdc									
30	H	7-1/2	10	15	20	—	DT361FGK	—	DT361FWK
60	H	20	25	30	50	—	DT362FGK	—	DT362FWK
100	H	30	40	60	75	—	DT363FGK	DT363FRK	DT363FWK
200	H	50	50	125	150	40	DT364FGK	DT364FRK	DT364FWK
400	T	—	—	250	350	50	DT365FGK	DT365FRK	DT365FWK

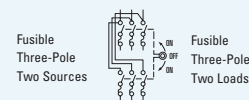

Double-throw heavy-duty non-fusible safety switches



DT363URK
Double-throw Heavy-Duty Non-Fusible Safety Switch, 100A, 600V

Double-throw 240 and 600 Vac heavy-duty, non-fusible

Specifications

- 30–800A
- Horsepower rated
- Suitable for service entrance use with neutral or ground lug kit installed
- Suitable for use as a manually operated switch per 2005 NEC Article 702
- UL listed File No. E5239

Features

- Palm-fitting, visible red handle
- Tri-lingual nameplate
- Side opening doors on all enclosures
- Visible, embossed red ON-OFF indication
- Tangential knockouts (30–100A) on top and bottom endwall (bottom only on NEMA 3R); concentric knockouts on higher ratings, and sides and rear of 30–100A
- Lockable door hasp
- Lockable handle
- Three-point mounting (30–100A)
- Four-point mounting (200–800A)
- Terminals suitable for 60° or 75°C Al or Cu wire on 30–100A; 75°C Al or Cu wire on higher ratings
- Rounded shroud
- Full range of accessories
- Door cannot be opened with the switch ON; switch cannot be turned ON with door open (without operating interlock defeater)
- Suitable for use on a circuit capable of delivering not more than 100,000 rms symmetrical amperes when protected by Class R or J fuses (30–200A); R, T or J fuses (400–800A). Short-circuit rating is 10,000 rms symmetrical amperes when protected by any other overcurrent protective device
- Double-break visible rotary blades; quick-make, quick-break operation

Double-Throw 240 Vac Heavy-Duty, Non-Fusible

Ampere Rating Main and Standby	Maximum Horsepower Ratings			NEMA 1 Enclosure Indoor Catalog Number	NEMA 3R Enclosure Rainproof Catalog Number
	Single-Phase 240 Vac	Three-Phase 240 Vac	250 Vdc		
Non-Fusible Two-Pole—240 Vac—250 Vdc					
30	3	—	5	DT221UGK	—
60	10	—	10	DT222UGK	—
100	20	—	20	DT223UGK	—
200	15	—	40	DT224UGK	DT224URK
400	—	—	50	DT225UGK	DT225URK
600	—	—	—	DT226UGK	—
Non-Fusible Three-Pole—240 Vac—250 Vdc					
30	3	10	5	DT321UGK	—
60	10	20	10	DT322UGK	—
100	20	40	20	DT323UGK	DT323URK
200	15	60	40	DT324UGK	DT324URK
400	—	125	50	DT325UGK	DT325URK
600	—	125	50	DT326UGK	—
800	—	125	50	DT327UGK ① ②	—
800	—	125	50	DT327UGK-N	—

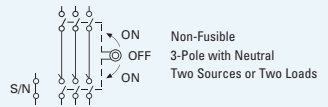
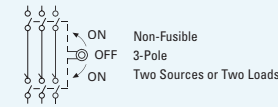
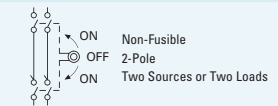

① Warning: Switch is not approved for service entrance.

② Field-installable neutral kit is not available. If a neutral is required, order the catalog number shown in the table with "N" suffix.



Double-throw heavy-duty non-fusible safety switches



Double-Throw 600 Vac Heavy-Duty, Non-Fusible

Ampere Rating Main and Standby	Maximum Horsepower Ratings					NEMA 1 Enclosure Indoor	NEMA 3R Enclosure Rainproof	NEMA 12 Enclosure Industrial, Dust-Tight	NEMA 4X Enclosure, Corrosion-Resistant, Stainless Steel	Catalog Number	Catalog Number	Catalog Number	Catalog Number
	Single-Phase	Three-Phase											
	480 Vac	600 Vac	480 Vac	600 Vac	480 Vdc								
Two-Pole—600 Vac—250 Vdc													
30	7-1/2	10	—	—	5	DT261UGK	—	—	—	—	—	—	—
60	20	25	—	—	10	DT262UGK	—	—	—	—	—	—	—
100	40	50	—	—	20	DT263UGK	—	—	—	—	—	—	—
200	50	50	—	—	40	DT264UGK ①	DT264URK ①	—	—	—	—	—	—
400	—	—	—	—	50	DT265UGK	DT265URK	—	—	—	—	—	—
600	—	—	—	—	50	DT266UGK	DT266URK	—	—	—	—	—	—
Three-Pole—600 Vac—250 Vdc													
30	7-1/2	10	20	30	5	DT361UGK	DT361URK	DT361UDK ④	DT361UWK	—	—	—	—
60	20	25	50	60	10	DT362UGK	DT362URK	DT362UDK ④	DT362UWK	—	—	—	—
100	40	50	75	100	20	DT363UGK	DT363URK	DT363UDK ④	DT363UWK	—	—	—	—
200	50	50	125	150	40	DT364UGK	DT364URK	DT364UDK ④	DT364UWK	—	—	—	—
400	—	—	250	350	50	DT365UGK	DT365URK	DT365UDK ④ ⑤	DT365UWK	—	—	—	—
600	—	—	250	350	50	DT366UGK	DT366URK	— ④	—	—	—	—	—
800	—	—	250	350	50	DT367UGK ② ③	DT367URK ② ③	— ④	—	—	—	—	—
800	—	—	250	350	50	DT367UGK-N	DT367URK-N	— ④	—	—	—	—	—
Four-Pole—600 Vac—250 Vdc ②													
30	7-1/2	10	20	30	5	—	DT461URK	—	—	—	—	—	—
60	20	25	50	60	10	—	DT462URK	—	—	—	—	—	—
100	40	50	75	100	20	—	DT463URK	—	—	—	—	—	—
200	—	50	125	150	40	DT464UGK	DT464URK	—	—	—	—	—	—
400	—	—	250	350	50	DT465UGK	DT465URK	—	—	—	—	—	—
600	—	—	250	350	50	DT466UGK	DT466URK	—	—	—	—	—	—
800	—	—	250	350	50	DT467UGK	DT467URK	—	—	—	—	—	—
Six-Pole—600 Vac—250 Vdc ②													
30	7-1/2	10	15	30	5	—	DT661URK	—	—	—	—	—	—
60	20	25	50	60	10	—	DT662URK	—	—	—	—	—	—
100	40	50	75	100	20	—	DT663URK	—	—	—	—	—	—

- ① Rated 600 Vdc, 50 hp in addition to ratings shown in table.
- ② Warning: Switch is not approved for service entrance.
- ③ Field-installable neutral kit is not available. If a neutral is required, order the catalog number shown in the table with "N" suffix.
- ④ NEMA 12 enclosures (30–800A) can be field modified to meet NEMA 3R rainproof requirements when a factory-provided drain hole is opened.
- ⑤ Also available in 240 Vac, catalog number DT325UDK.



Double-throw heavy-duty switching neutral safety switches

Double-throw safety switches applied in emergency power or generator applications may require a switched neutral in lieu of a solid neutral. If the neutral of the generator is bonded to a grounding system at the generator, then a separately derived system (reference NEC 250-20[D] and Exhibit 250.7) has been created and a switched neutral in the double-throw safety switch is required. The switching neutral is required to avoid the potential for backfeeding of the power that might occur if the safety switch neutral is also bonded. If the generator neutral is brought to the service where it is bonded and grounded, then a non-separately derived system has been created and a solid neutral must be used in the double-throw safety switch. Most double-throw safety switches in today's market are provided with solid neutrals and are not UL listed for switching neutral application. The market, some utilities and local codes are requiring the ability to break or switch the neutral on three- and four-pole double-throw switches with a UL listing for that capability. Three-pole switches are used for single-phase switching neutral applications, while four-pole switches are used for three-phase switching neutral applications. In many cases, three- and four-pole double-throw safety switches are being installed in the field with the left-most pole being used as the switching neutral, but the switch is not UL listed for that application.

Eaton non-fusible three-pole and four-pole double-throw safety switches 30–800A are UL listed for switching neutral application with the proper installation of the applicable switching neutral bonding kit shown in the Accessories section of this brochure. Each bonding kit comes with applicable materials, hardware, instruction sheet and adhesive-backed wiring schematic. The bonding kits can only be used on non-fusible double-throw safety switches. When a bonding kit is applied to a three-pole switch, the switch becomes a single-phase switch with single-phase horsepower ratings. A double-throw safety switch with the appropriate bonding kit installed is suitable for service entrance use. Typically, a four-pole double-throw safety switch is not suitable for service entrance use; however, with the appropriate bonding kit installed, the four-pole switch is suitable for service entrance use as noted on the device publication of the product. Switching neutral bonding kits can also be factory installed by Eaton's unique Switching Device Flex Center. See the end of this brochure for additional information on the Flex Center.

Bonding kit schematic
Single-phase applications requiring a neutral pole bonding kit

Bonding kit schematic
Three-phase applications requiring a neutral pole bonding kit

Notes: NEC 702 application, separately derived system and service equipment.
Two sources with switched neutral, generator is a separately derived system.
Proper installation is governed by interpretation of the NEC, applicable local codes and local utility requirements. Applicable sections of these codes and requirements should be referenced prior to installation.

Double-Throw Switching Neutral Safety Switch
(upper switch base assembly is shown)



Accessories, hubs and standard lug capacities

Accessories

Neutral, ground lug, control pole and auxiliary contact kits contain materials for one switch base. Copper lug, 60A J fuse and R fuse kits contain materials for one three-pole switch base. Switching neutral bonding and 400A J fuse kit contents are for one complete double-throw switch. Applicable accessories for a specific safety switch can also be found on the inside door publication of the switch

Description	Catalog Number
Neutral Kits/Ground Kits ①	
30–100A	DT100NK
200A	DT200NK
400A Non-Fusible	DT400NK
600A Non-Fusible	DT600NK
400–600A Fusible	DS800NK
Ground Lug Kits ①	
30–100A ②	DS100GK
200A	DS200GK
400–800A	DS468GK
Switching Neutral Bonding Kits ③	
30–100A, Three-Pole, Four-Pole Non-Fusible	DT100BK
200A, Three-Pole, Four-Pole Non-Fusible	DT200BK
400A, Three-Pole, Four-Pole Non-Fusible	DT400BK
600A, Three-Pole, Four-Pole Non-Fusible	DT600BK
800A, Three-Pole, Four-Pole Non-Fusible	DT800BK
Control Pole Kit ①	
30–800A	DS16CP
Auxiliary Contact Kits ①	
1NO/1NC	DS200EK1
2NO/2NC	DS200EK2
Copper Lug Kits ①	
30–60A	DS16CL
100A	DS36CL
J Fuse Adapter Kits ④	
60A	DS26JK
400A 600V	DT400JK
R Fuse Adapter Kits ④	
30A, 240V	DS12FK
30A, 600V; 60A, 240V	DS16FK
60A, 600V	DS26FK
100A, 240–600V	DS36FK
200A, 240–600V	DS46FK
400A, 240V	DS56FK
Lubricating Grease for Safety Switch Blades and Contacts	
Each kit contains three 30 cc tubes of lubricating grease.	

- ① For heavy-duty and general-duty quick-make, quick-break.
- ② Ground bar kit is not listed on device publications.
- ③ For heavy-duty non-fusible.
- ④ For heavy-duty fusible.

Hubs

Catalog Number **DS900AP** Adapter Kit permits installation of Group 1 hubs on 200A double-throw switches.

Plate Type Hubs For NEMA 3R Enclosures (Up to 200A)			
Group 1 General-Duty, Heavy-Duty, Double-Throw through 100A		Group 2 General-Duty, Heavy-Duty, Double-Throw through 200A	
Conduit Size in Inches (mm)	Catalog Number	Conduit Size in Inches (mm)	Catalog Number
0.75 (19.1)	DS075H1	2.00 (50.8)	DS200H2
1.00 (25.4)	DS100H1	2.50 (63.5)	DS250H2
1.25 (31.8)	DS125H1	3.00 (76.2)	DS300H2
1.50 (38.1)	DS150H1	—	—
2.00 (50.8)	DS200H1	—	—

Myers Type Hubs NEMA 3R (400A and Above) NEMA 4X (Stainless Steel) and 12	
Conduit Size in Inches (mm)	Catalog Number
0.50 (12.7)	DS050MH
0.75 (19.1)	DS075MH
1.00 (25.4)	DS100MH
1.25 (31.8)	DS125MH
1.50 (38.1)	DS150MH
2.00 (50.8)	DS200MH
2.50 (63.5)	DS250MH
3.00 (76.2)	DS300MH
3.50 (88.9)	DS350MH
4.00 (101.6)	DS400MH
5.00 (127.0)	DS500MH

Standard lug capacities

Although certain lug capacities are larger than required, only minimum wire bending space is provided per the requirements noted in NEC Tables 373-6 (a) and (b) for respective ampere ratings.

Description	Minimum Wire Size	Maximum Wire Size	Wire Type
30A	#14	#2	Cu/Al
60A	#14	#2	Cu/Al
100A	#14	#1/0	Cu/Al
200A	#6	250 kcmil	Cu/Al
400A	(2) #1/0	(2) 300 kcmil	Cu/Al
600A Fusible	(1) #1/0	(1) 750 kcmil	Cu/Al
600A Non-Fusible	(1) #2	(1) 600 kcmil	Cu/Al
800A	(1) #1/0	(1) 750 kcmil	Cu/Al
	(2) #250	(2) 500 kcmil	Cu/Al
	(3) #250	(3) 500 kcmil	Cu/Al
Copper-Bodied Lugs			
30A	#14	#6	Cu
60A	#14	#4	Cu
100A	#6	#1/0	Cu
200A	#6	250 kcmil	Cu
400A	#1/0	500 kcmil	Cu
600A	(2) #1/0	(2) 500 kcmil	Cu

1. **DT200NK**
200A Neutral/Ground Kit
2. **DS250H2**
Plate Type Hub
3. **DS26FK**
60A 600V R Fuse Adapter Kit
4. **DT100BK**
100A Switching Neutral Bonding Kit
5. **DS468GK**
400–800A Ground Lug Kit
6. **DS050MH**
Myers Hub
7. **DS200EK1**
Auxiliary Contact Kit 1NO/1NC
8. **DS16CP**
Control Pole Kit
9. **DS26JK**
60A J Fuse Adapter Kit
10. **DS16CL**
30–60A Copper Lug Kit

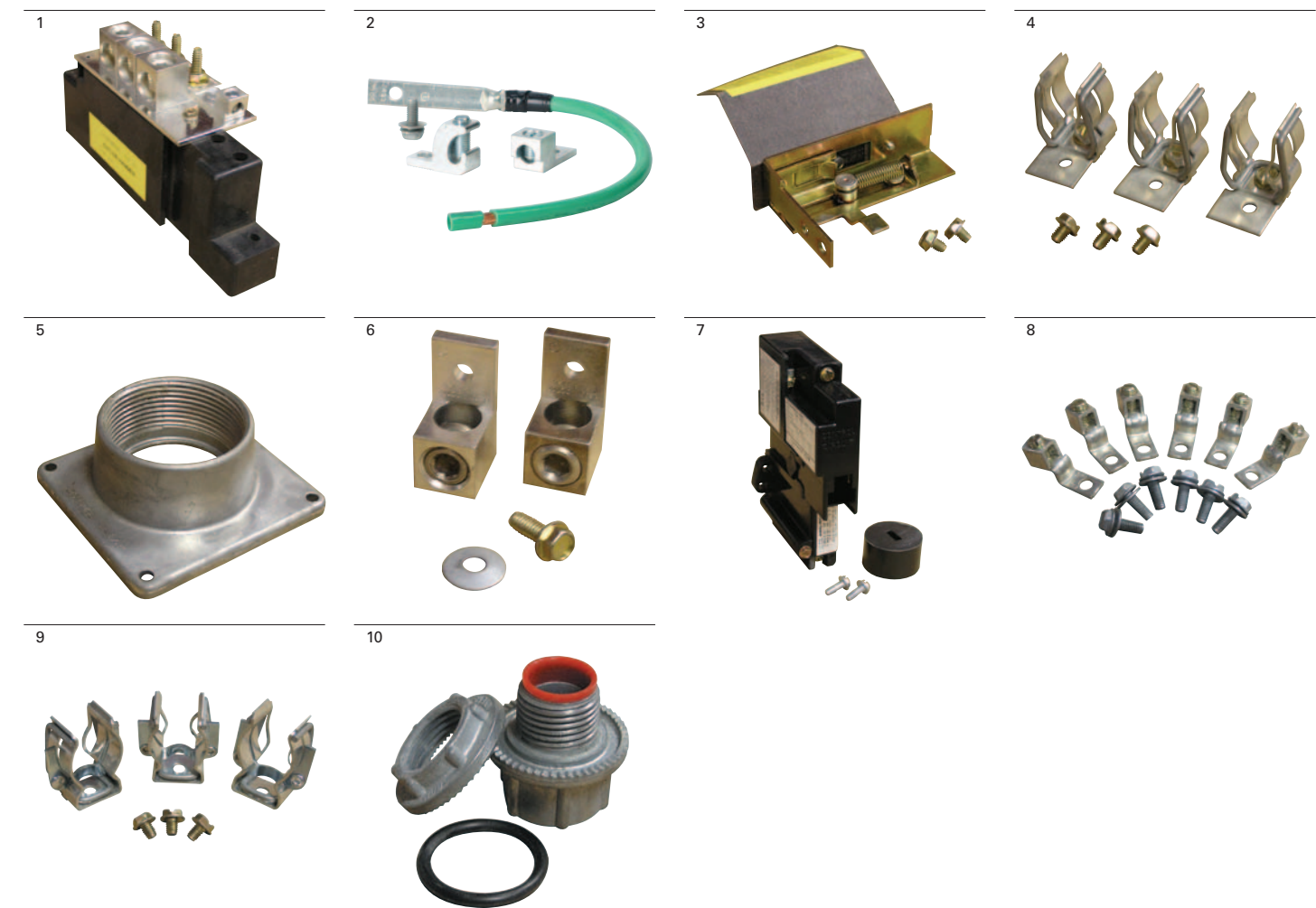

Dimensions and weights

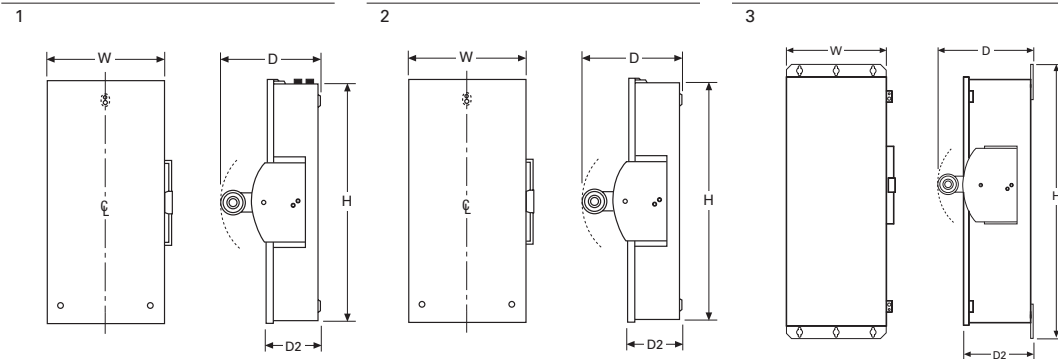

1. General-Duty NEMA 3R
30–400A
2. Heavy-Duty NEMA 1, 3R
30–800A
3. Heavy-Duty NEMA 12, 4X
30–400A

Note
Contact your Eaton sales office for outline drawings and mounting dimensions.

Double-Throw General-Duty, Non-Fusible, 240V, Two-Pole Solid Neutral, Quick-Make, Quick-Break Design

NEMA 3R Dimensions in Inches (mm)					
Ampere Rating	Height (H)	Width (W)	Depth (D)	Depth (D2)	Weight Lbs (kg)
30	24.63 (625.6)	11.94 (303.3)	9.88 (251.0)	5.38 (136.7)	34 (15.4)
60	24.63 (625.6)	11.94 (303.3)	9.88 (251.0)	5.38 (136.7)	34 (15.4)
100	24.63 (625.6)	11.94 (303.3)	9.88 (251.0)	5.38 (136.7)	34 (15.4)
200	37.38 (949.5)	19.56 (496.8)	11.25 (285.8)	6.10 (154.9)	80 (36.3)
400	53.81 (1366.8)	23.13 (587.5)	12.50 (317.5)	8.88 (225.6)	140 (63.6)

Double-Throw General-Duty, Non-Fusible, 240V, Two-Pole Solid Neutral, Compact Design

NEMA 3R Dimensions in Inches (mm)					
Ampere Rating	Height (H)	Width (W)	Depth (D)	Depth (D2)	Weight Lbs (kg)
30	14.69 (373.1)	9.63 (244.6)	10.81 (274.6)	5.23 (132.8)	12 (5.4)
60	14.69 (373.1)	9.63 (244.6)	10.81 (274.6)	5.23 (132.8)	12 (5.4)
100	14.69 (373.1)	9.63 (244.6)	10.81 (274.6)	5.23 (132.8)	12 (5.4)

Double-Throw Heavy-Duty, Non-Fusible, 240V and 600V, Three-Pole

Ampere Rating	NEMA 1, 3R Dimensions in Inches (mm)					NEMA 12, 4X Stainless Steel Dimensions in Inches (mm)				
	Width (W)	Height (H)	Depth (D)	Depth (D2)	Weight Lbs (kg)	Width (W)	Height (H)	Depth (D)	Depth (D2)	Weight Lbs (kg)
30	11.94 (303.3)	24.63 (625.6)	9.88 (251.0)	5.38 (136.7)	34 (15.4)	12.00 (304.8)	25.88 (657.4)	10.25 (260.4)	5.50 (139.7)	60 (27.2)
60	11.94 (303.3)	24.63 (625.6)	9.88 (251.0)	5.38 (136.7)	34 (15.4)	12.00 (304.8)	25.88 (657.4)	10.25 (260.4)	5.50 (139.7)	60 (27.2)
100	11.94 (303.3)	24.63 (625.6)	9.88 (251.0)	5.38 (136.7)	34 (15.4)	12.00 (304.8)	25.88 (657.4)	10.25 (260.4)	5.50 (139.7)	60 (27.2)
200	19.56 (496.8)	37.38 (949.5)	11.25 (285.8)	6.10 (154.9)	80 (36.3)	19.50 (495.3)	41.00 (1041.4)	11.63 (295.4)	6.48 (164.6)	105 (47.6)
400	23.13 (587.5)	53.81 (1366.8)	12.50 (317.5)	7.25 (184.2)	140 (63.6)	23.00 (584.2)	57.50 (1460.5)	12.50 (317.5)	7.25 (184.2)	185 (83.9)
600	24.13 (612.9)	63.31 (1608.1)	14.13 (358.9)	8.88 (225.6)	175 (79.4)	—	—	—	—	—
800	24.13 (612.9)	63.31 (1608.1)	14.13 (358.9)	8.88 (225.6)	175 (79.4)	—	—	—	—	—

Double-Throw Heavy-Duty, Fusible, 240V and 600V, Three-Pole

Ampere Rating	NEMA 1, 3R Dimensions in Inches (mm)					NEMA 12, 4X Stainless Steel Dimensions in Inches (mm)				
	Width (W)	Height (H)	Depth (D)	Depth (D2)	Weight Lbs (kg)	Width (W)	Height (H)	Depth (D)	Depth (D2)	Weight Lbs (kg)
30	11.94 (303.3)	36.63 (930.4)	9.88 (251.0)	5.38 (136.7)	44 (20.0)	12.00 (304.8)	39.81 (1011.2)	10.25 (260.4)	5.50 (139.7)	45 (20.4)
60	11.94 (303.3)	36.63 (930.4)	9.88 (251.0)	5.38 (136.7)	44 (20.0)	12.00 (304.8)	39.81 (1011.2)	10.25 (260.4)	5.50 (139.7)	45 (20.4)
100	11.94 (303.3)	36.63 (930.4)	9.88 (251.0)	5.38 (136.7)	44 (20.0)	12.00 (304.8)	39.81 (1011.2)	10.25 (260.4)	5.50 (139.7)	45 (20.4)
200	19.56 (496.8)	50.88 (1292.4)	11.25 (285.8)	6.10 (154.9)	95 (43.1)	19.56 (496.8)	55.63 (1413.0)	11.63 (295.4)	6.46 (164.1)	100 (45.4)
400	25.38 (644.7)	74.75 (1898.7)	14.13 (358.9)	8.88 (225.6)	230 (104.3)	25.38 (644.7)	74.75 (1898.7)	14.13 (358.9)	8.92 (226.6)	260 (117.9)
600	27.44 (697.0)	86.13 (2187.7)	14.13 (358.9)	8.88 (225.6)	320 (145.1)	—	—	—	—	—



Short-circuit ratings



Short-Circuit Ratings Using Class R, T or J Fusing Where Applicable

Class H fuse clips supplied as standard for 30–600A except Class T for 400A at 600V, and 600A at 240V. Rated at 10,000 rms symmetrical when using Class H fuses.

Not applicable to the Compact Design. The Compact Design is suitable for use on a circuit capable of delivering not more than 10,000 rms symmetrical amperes.

Ampere Rating	Voltage Ratings Type 1	Type 3R	Type 12	Type 4X
30	100k at 600	100k at 600	100k at 600	100k at 600
60	100k at 600	100k at 600	100k at 600	100k at 600
100	100k at 600	100k at 600	100k at 600	100k at 600
200	100k at 600	100k at 600	100k at 600	100k at 600
400	100k at 600	100k at 600	100k at 600	100k at 600
600	100k at 600	100k at 600	100k at 600	100k at 600
800	100k at 600	100k at 600	—	—

Non-fusible switches

The UL listed short-circuit ratings for Eaton non-fusible switches are based on the switches being properly protected by overcurrent protective devices. For applications that require a UL listed short-circuit rating of 10,000 rms symmetrical amperes or less, an Eaton non-fusible switch must be properly protected by any overcurrent protective device rated no greater than the ampere rating of the switch. For applications that require a UL listed short-circuit rating of greater than 10,000 rms symmetrical amperes, an Eaton non-fusible switch must be properly protected by the appropriate class and size fusing noted on the switch publication. Otherwise, this non-fusible switch must be replaced with an Eaton fusible switch that uses the appropriate fusing required.

Safety switch short circuit ratings are applicable to AC only.

Safety switch I^2t and I_p values are identical to UL maximum acceptable I^2t and I_p values for the corresponding class fuse.

Renewal parts

Replacement parts for a specific catalog number are shown on the inside door label (publication) of the switch. Switch bases, fuse bases, line shields (fusible switches) and operating handles (400A and above) are typically available as applicable. For additional information, refer to *Renewal Parts Catalog* RPO0801001E.

Flex center

Our Cleveland, TN, Switching Devices Flex Center is a solutions center that designs and modifies safety switches, enclosed circuit breakers and rotary disconnects for unique customer needs that are not met by standard products. The Flex Center is a one-of-a-kind operation that is capable of solving our customers' issues, while our competition is content to offer their customers only catalog items.

The Flex Center staff has over 120 years of design, manufacturing and industry experience, and has been providing solutions to our customers since 1998. While you may think that your power switching needs are unlike any other, chances are, the Flex Center staff has already "been there, done that."

For further information on our customized solutions for harsh environments, safety and convenience, please refer to our Flex Center brochure SA00801002E or contact the Flex Center at 1-888-329-9272.

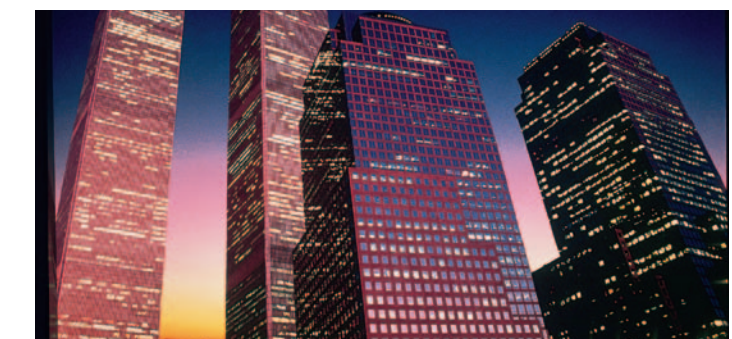

Eaton's Electrical Sector is a global leader in power distribution, power quality, control and automation, and monitoring products. When combined with Eaton's full-scale engineering services, these products provide customer-driven PowerChain™ solutions to serve the power system needs of the data center, industrial, institutional, public sector, utility, commercial, residential, IT, mission critical, alternative energy and OEM markets worldwide.

PowerChain solutions help enterprises achieve sustainable and competitive advantages through proactive management of the power system as a strategic, integrated asset throughout its life cycle, resulting in enhanced safety, greater reliability and energy efficiency. For more information, visit www.eaton.com/electrical.

Eaton Corporation
Electrical Sector
1111 Superior Ave.
Cleveland, OH 44114
United States
877-ETN-CARE (877-386-2273)
Eaton.com

© 2010 Eaton Corporation
All Rights Reserved
Printed in USA
Publication No. BR00801002E / Z10432
November 2010



**PowerChain
Management®**

PowerChain Management is a registered trademark of Eaton Corporation.

All other trademarks are property of their respective owners.



Powering Business Worldwide