

SIRIUS

Überlastrelais

Overload Relay

Relais de surcharge

Relé de sobrecarga

Relè di sovraccarico

Relé de sobrecarga

3RU1.4



EN 60947, IEC 60947

Montageanleitung/Assembly Instructions

Bestell-Nr./Order No.: 3ZX1012-0RU11-1DA1

	⚠️ WARNUNG Gefährliche elektrische Spannung! Kann zu elektrischem Schlag und Verbrennungen führen. Vor Beginn der Arbeiten Anlage und Gerät spannungsfrei schalten.	⚠️ WARNING HAZARDOUS VOLTAGE. Can cause electrical shock and burns. Disconnect power before proceeding with any work on this equipment.	⚠️ ATTENTION Tension dangereuse ! Risque d'électrocution et de brûlure. Isoler cet appareil du réseau avant d'y intervenir pour travaux.
	⚠️ PRECAUCIÓN ¡Tensión peligrosa! Puede causar choque eléctrico y quemaduras. Desconectar la alimentación antes de efectuar trabajo alguno en este equipo.	⚠️ ATTENZIONE Tensione elettrica pericolosa! Rischio di shock elettrico e ustioni. Prima di eseguire qualsiasi tipo di lavoro, assicurarsi che l'apparecchio e l'impianto siano scollegati.	⚠️ AVISO Tensão elétrica perigosa! Pode causar um choque eléctrico e queimaduras. Antes de iniciar os trabalhos, desligue a tensão da unidade e do aparelho.

Eine sichere Gerätefunktion ist nur mit zertifizierten Komponenten gewährleistet.

Reliable functioning of the equipment is only ensured with certified components.

Le fonctionnement sûr de l'appareil n'est garanti qu'avec des composants certifiés.

El funcionamiento seguro del aparato sólo está garantizado con componentes certificados.

Il funzionamento sicuro dell'apparecchiatura viene garantito soltanto con componenti certificati.

O funcionamento seguro do aparelho apenas pode ser garantido se forem utilizados os componentes certificados.

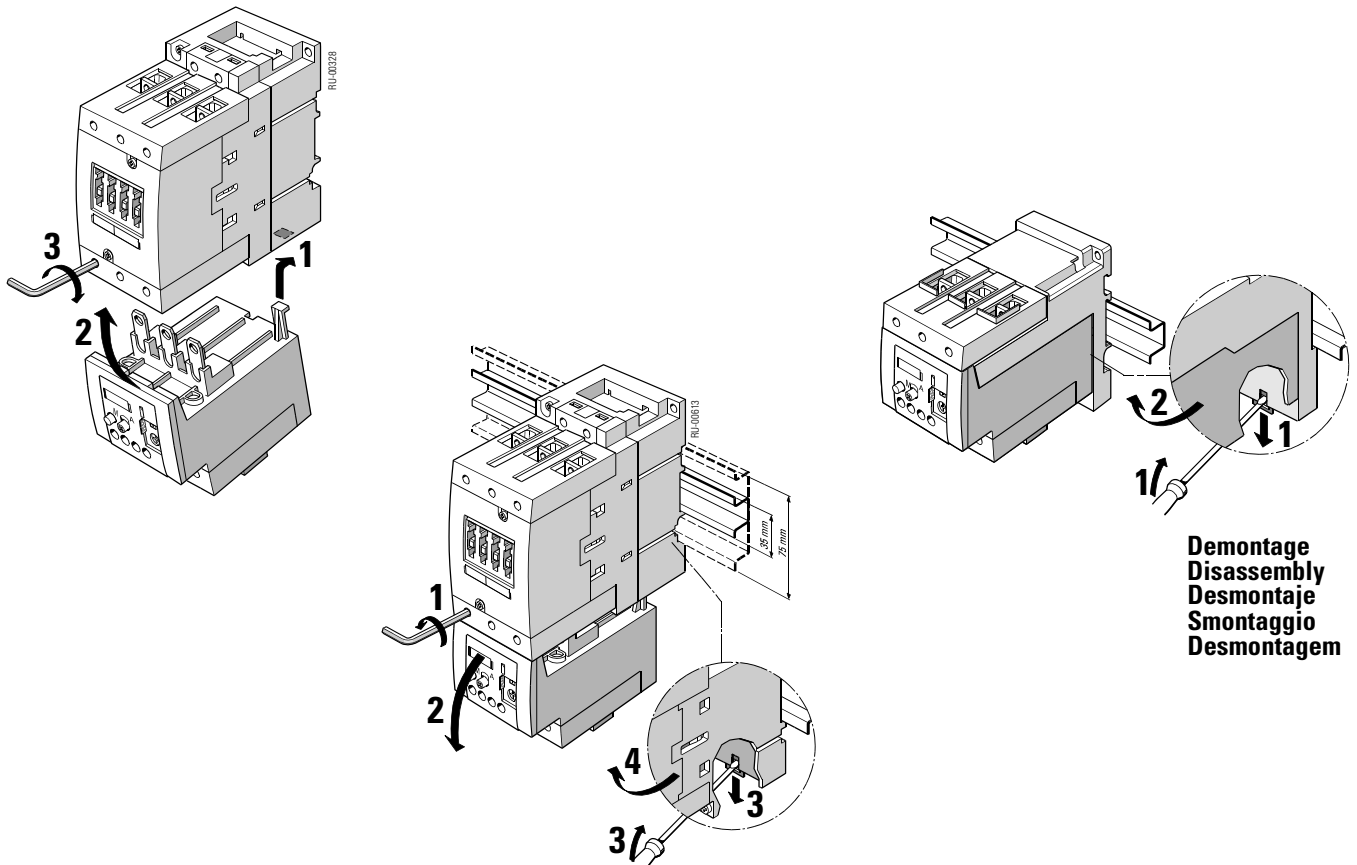

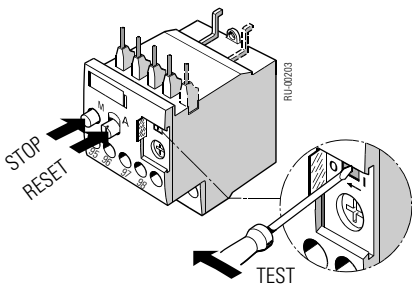
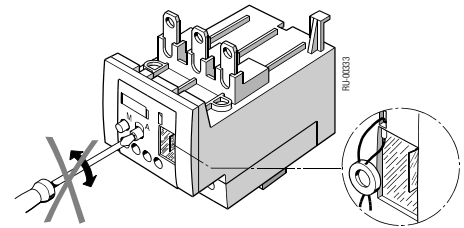
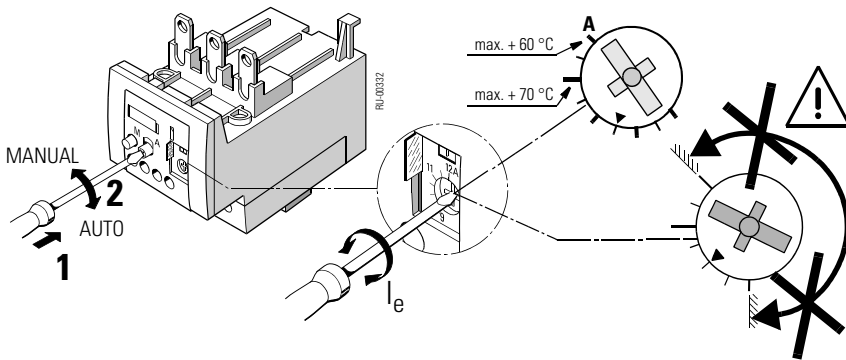
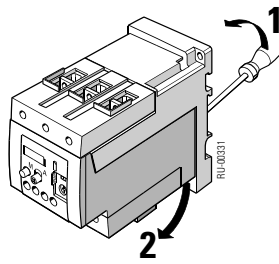
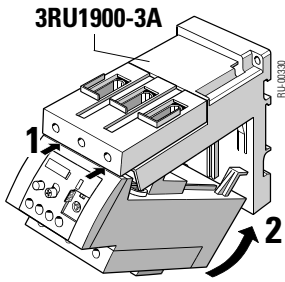

	TEST	STOP	RESET
NC 95-96			
NO 97-98			

Fernreset: Einschaltdauer 0,2 bis 4 s; Einschalthäufigkeit 60/h

Remote reset: ON period 0.2 to 4 s; operating cycles: 60 per hour

Réarmement à distance : Durée de l'ordre 0,2 à 4 s ; Fréquence de réarmement 60/h

Rearme remoto: Ciclo de trabajo 0,2 a 4 s; Frecuencia de maniobra 60/h

Reset remoto: Rapporto d'inserzione da 0,2 a 4 s; frequenza d'inserzione 60/h

Reset de comando: Duração de acionamento 0,2 até 4 s; Ciclos de acionamento 60/h

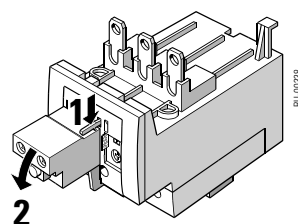
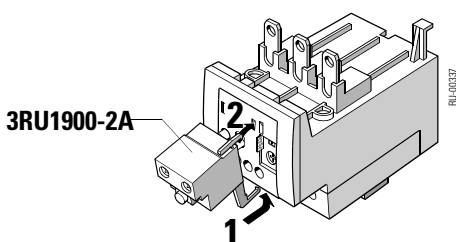

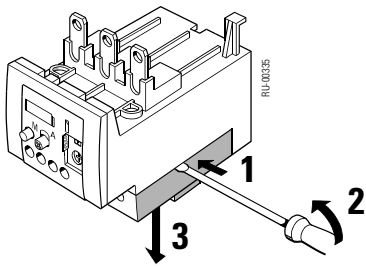

3RT1946-4EA1

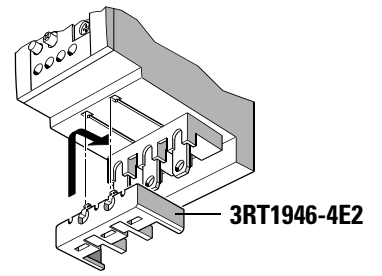
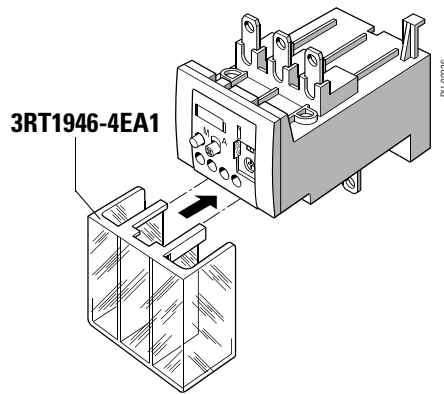



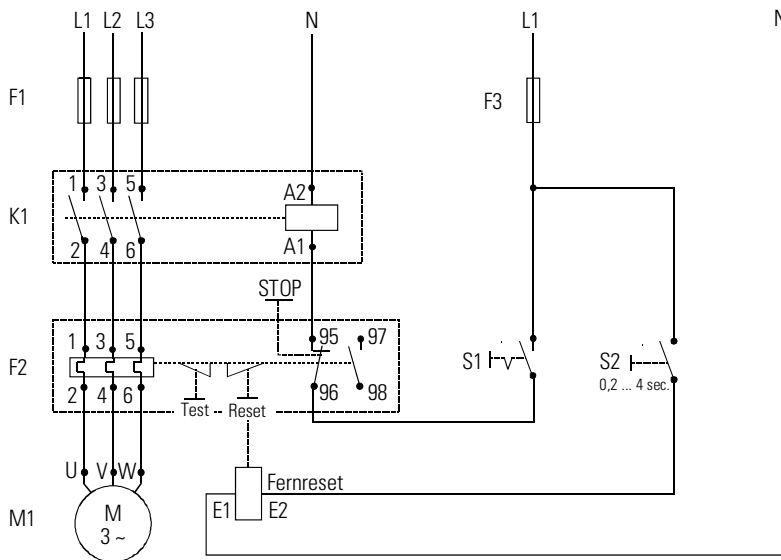

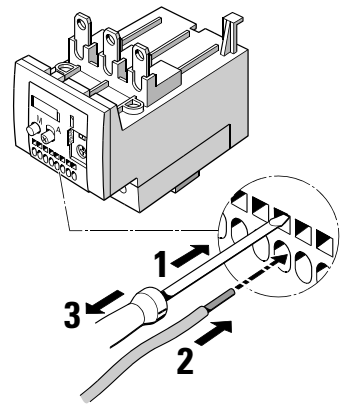

3RT1946-4E2



3RU1.46-..D



	A1/A2; NO/NC			L1, L2, L3
	3RU1.46-..B	3RU1.46-..D		T1, T2, T3
 Ø 5 ... 6 mm / PZ2	0,8 ... 1,2 Nm 7 to 10.3 lb-in	—		4 ... 6 Nm 35 to 53 lb-in
	2 x 0,5 ... 1,5 mm ² 2 x 0,75 ... 2,5 mm ²	2 x 0,5 ... 2,5 mm ²		2 x 2,5 ... 16 mm ²
	2 x 0,5 ... 2,5 mm ²	2 x 0,5 ... 1,5 mm ²		2 x 2,5 ... 35 mm ² 1 x 2,5 ... 50 mm ²
—	—	—		2 x 10 ... 50 mm ² 1 x 10 ... 70 mm ²
AWG	2 x 18 to 14	2 x 18 to 14	AWG	2 x 10 to 1/0 1 x 10 to 2/0

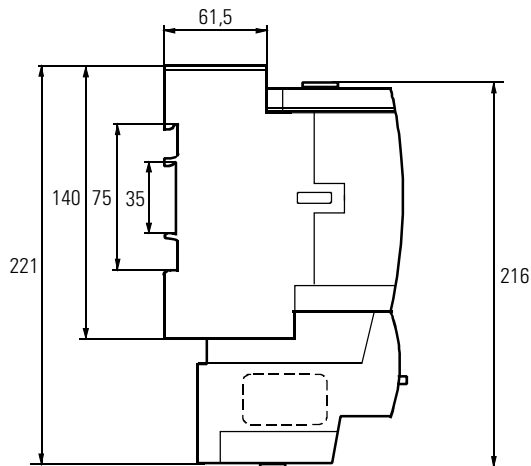
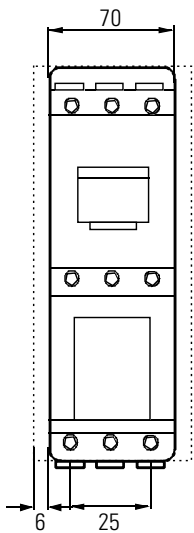
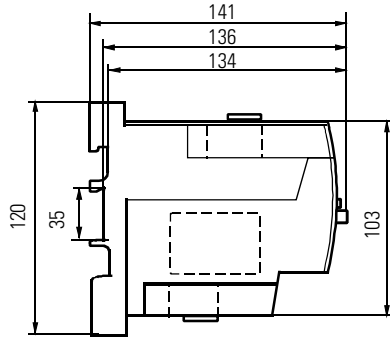
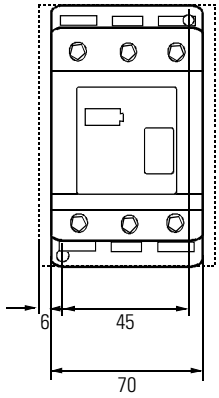
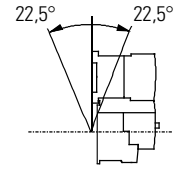
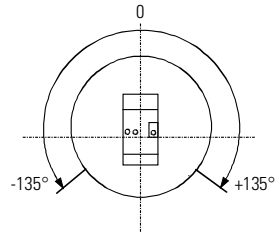
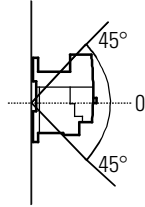
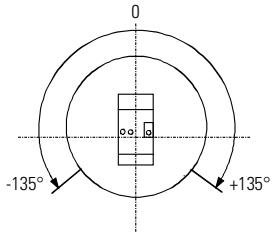

Technical Assistance: Telephone: +49 (0) 9131-7-43833 (8°° - 17°° CET) Fax: +49 (0) 9131-7-42899
 E-mail: technical-assistance@siemens.com
 Internet: www.siemens.de/lowvoltage/technical-assistance

Technical Support: Telephone: +49 (0) 180 50 50 222