

SENSORS

Catalog & Application Guide

Vol. 1 - March 2020



HUBBELL[®]
Control Solutions



HUBBELL[®]
Lighting

SENSORS

Hubbell Control Solutions (HCS) offers one of the industry's broadest selections of Occupancy/Vacancy Sensors. Utilizing the embedded IntelliDAPT® technology, HCS Sensors analyze the controlled area to make automatic adjustments in both sensitivity and timing settings for optimal performance, energy savings and maintenance-free operations. For more information, visit the literature section of our website at hubbellcontrolsolutions.com.

TABLE OF CONTENTS

- 4 Energy Conservation
- 6 Code Compliance
- 8 OMNI®
- 12 LightOWL®
- 16 LightHAWK®
- 20 WASP
- 24 IntelliDAPT Technology
- 26 Sensor Technology
- 28 Application Solutions
- 44 Design Guide
- 58 Technical Support





ENERGY CONSERVATION AT THE FOREFRONT

A significant energy conservation movement has been established across the globe in the form of local, state and national programs, standards and codes that call for energy efficiency in both commercial and residential buildings. These codes and standards include:

- LEED® (Leadership in Energy and Environmental Design) certification in new and renovated facilities through the U.S. Green Building Council (USGBC) promotes sustainable building design.
- California Energy Commission's (CEC) Title 24 program enforces stringent standards and regulations to reduce energy consumption, including automatic lighting control and shut-off.
- ASHRAE/IESNA 90.1 energy efficiency code requires interior lighting in buildings larger than 5000 sq. ft. to be controlled with automatic devices.
- IECC® (International Energy Conservation Code) compliance requires automatic shut-off of lighting which is now adopted by most states in some form.

As energy concerns increase, the "greening" of commercial and residential buildings will continue through more stringent standards and additional energy conservation initiatives like the EPA's ENERGY STAR program and the 2030 Challenge that aims to reduce energy use by 50% by 2030.

OCCUPANCY SENSORS PLAY A KEY ROLE

In the U.S., lighting consumes 22% of electricity and represents over \$40 billion a year in energy costs. Using advanced technology, Hubbell Control Solutions' Occupancy Sensors save energy and provide sustainability by automatically and effectively turning lights on when a room is occupied and off when a room is vacant. In a typical office building where lighting accounts for 35 to 45% of energy use, HCS Occupancy Sensors reduce wasted lighting by 13 to 90% for a significant return on investment (ROI).

Broad Sensor Product Range

HCS offers the broadest range of occupancy and vacancy sensors on the market that meet the latest codes and standards, including ASHRAE/IESNA 90.1 and CEC's Title 24. HCS Occupancy Sensors can also provide LEED® points in categories like Sustainable Sites, Energy and Atmosphere, Indoor Environmental Quality and Innovative Design Process.

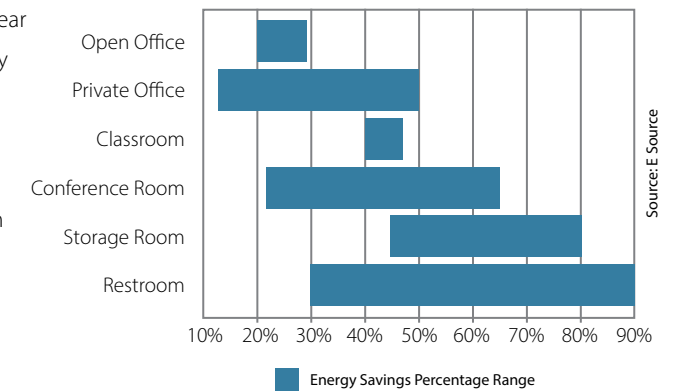



CODE COMPLIANCE AND ENERGY SAVINGS WITH STANDALONE SENSOR SOLUTIONS

While commercial lighting energy consumption continues to decline as a result of increased LED lighting efficacy and more stringent energy codes, there are still opportunities to maximize energy savings and meet or exceed today's energy code requirements through the deployment of LED luminaires controlled with occupancy/vacancy and daylight sensors.



High-End Trim - An artificial maximum light output set below actual maximum light output for each space



Local Control - Manual lighting controls that control all the lights in that space and requires human intervention

Multilevel control - Providing additional light levels in a space beyond Full ON and Full OFF



Continuous Daylighting - Automatically turns lights down to a reduced level or off based on the amount of daylight present in a space

Daylight OFF - Automatically turns the lights off based on the amount of daylight



Egress Lighting - The code establishes minimum criteria for the design of egress facilities so as to allow prompt escape of occupants from buildings, or where desirable, into safe areas within buildings.



Full OFF - Automatically turns the lights off within a set period of time after all occupants leave the space

Partial ON - Automatically turns lights on to a reduced level between full on and full off when occupants enter the space

Partial OFF - Automatically turns lights down to a reduced level between full on and full off after all occupants leave the space

CODE COMPLIANCE AT EVERY LEVEL OF SCALABILITY	ENERGY CODES			OCCUPANCY SENSOR SOLUTIONS		
	IECC 2015	ASHRAE 90.1 2016	Title 24 Part 6 2016	Wallswitch	Ceiling/Wall Mount	Area/Site
I N D O O R						
High-End Tuning				✓*	✗	✓*
Local Control	C405.2.2.3	9.4.1.1 (a)	130.1 (a)	✓	✓**	✗
Multilevel Control	C405.2.2.2	9.4.1.1 (b)	130.1 (b)	✓*	✗	✓*
Occupancy Sensor Full OFF	C405.2.1.1	9.4.1.1 (h)	130.1 (c) 6	✓*	✓	✓*
Occupancy Sensor Partial ON	C405.2.1.1	9.4.1.1 (c)	130.1 (c) 5	✓*	✗	✓*
Occupancy Sensor Partial OFF	C405.2.1.2	9.4.1.1 (g)	130.1 (c) 6	✗	✗	✓*
Continuous Daylighting	C405.2.3	9.4.1.1 (e)	130.1 (d)	✓*	✓	✓*
O U T D O O R						
Setback	C405.2.5(3)	9.4.1.1 (d)	C405.2.2.3			✓
Daylight OFF	C405.2.5(1)	9.4.1.1 (a)	C405.2.2.3			✓

* Requires dimming sensor

** Requires Power Pack with manual ON control

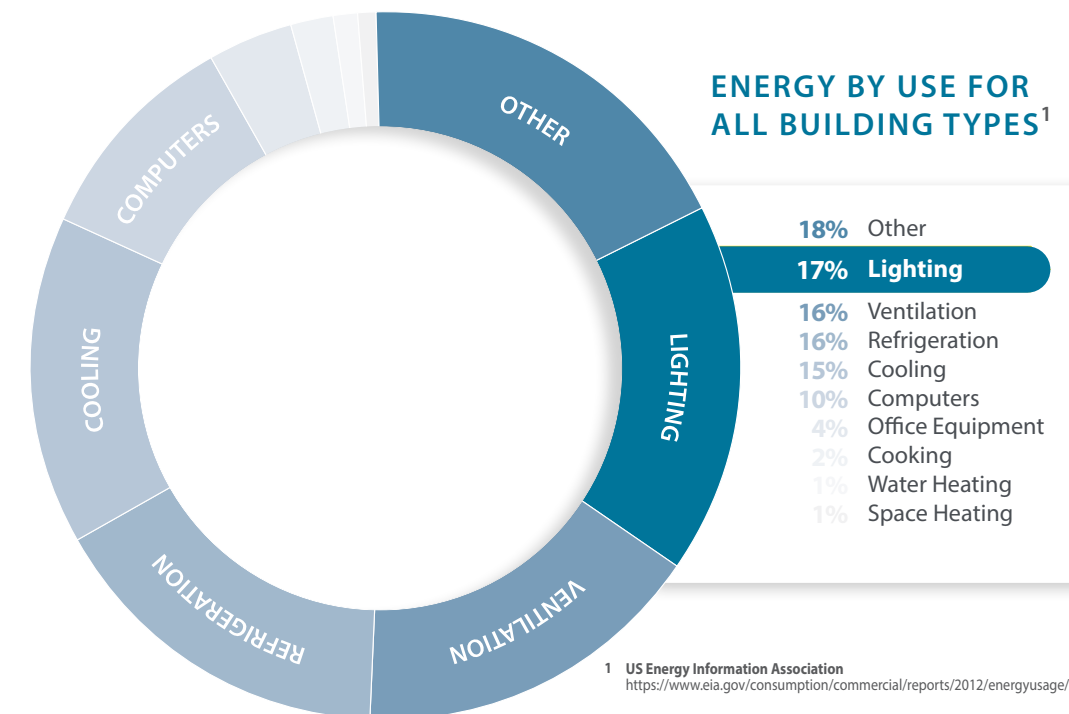

¹ US Energy Information Association
<https://www.eia.gov/consumption/commercial/reports/2012/energyusage/>

OMNI

The OMNI® Ceiling Mount Occupancy/Vacancy Sensor is designed for medium to large spaces with ceilings up to 12' in height. When a person enters into or out of a sensor zone, the sensor detects motion and switches the lights ON. The lights will remain ON as long as there is an occupant in the room. When the space being monitored by the sensor is unoccupied the unit will switch the lights OFF. For large spaces, up to four sensors can be linked together to control the lighting as a single group. This makes the OMNI sensor ideal for spaces such as cafeterias, classrooms, large bathrooms, offices with cubicles and more.

OMNI sensors utilize smart IntelliDAPT® Technology to analyze the controlled area and make digital adjustments to both sensitivity and timing settings for optimal performance, energy savings, and maintenance-free, install-and-forget operation.

Applications



Large Private Offices



Classrooms



Libraries



Conference Rooms



Large Bathrooms



Hallways

OMNI

OMNI® Ceiling Mount Occupancy/Vacancy Sensors

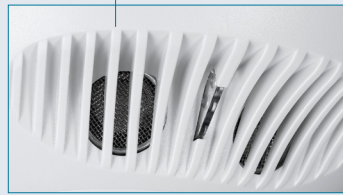

Features

- Ultrasonic (US) and Passive Infrared (PIR) technologies for unequalled motion detection
- Smart IntelliDAPT® technology eliminates false triggers
- 500-2,000 square-foot coverage area per sensor (depending on model)
- Optional relay and photocell control
- Five year warranty

Dimensions

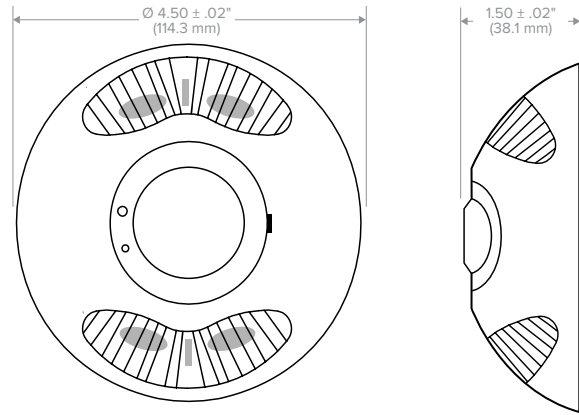

Accessories



Occupancy Sensor Accessories



Universal Voltage Power Packs



Controlled Receptacle



MP347A Power Pack



MPSHD Pack

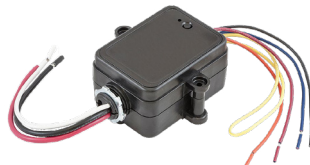

Heavy Duty Universal Voltage Power Packs

Available color options



Off-white

Technology



Certifications



Ordering Information

OMNI DT

OMNI	DT		
MODEL	TECHNOLOGY	COVERAGE	RELAY/PHOTOCELL OPTION
OMNI OMNI Sensor	DT Dual Technology	500 500 sq. ft. 1000 1,000 sq. ft. 2000 2,000 sq. ft.	RP Relay/Photocell Blank No Relay/Photocell

Ordering Example: OMNIDT500

OMNI US

OMNI	US		
MODEL	TECHNOLOGY	COVERAGE	RELAY/PHOTOCELL OPTION
OMNI OMNI Sensor	US Ultrasonic	500 500 sq. ft. 1000 1,000 sq. ft. 2000 2,000 sq. ft.	RP Relay/Photocell Blank No Relay/Photocell

Ordering Example: OMNIUS1000RP

OMNI PIR

OMNI	IR		
MODEL	TECHNOLOGY	COVERAGE	RELAY/PHOTOCELL OPTION
OMNI OMNI Sensor	IR Passive Infrared	L Long Range IR, 1,500 sq. ft. Blank 450 sq. ft.	RP Relay/Photocell Blank No Relay/Photocell

Ordering Example: OMNIIRL

Applications



Libraries



Cafeterias



Warehouses



Conference Rooms



Utility Closets/Storage Areas



LIGHTOWL

The LightOWL® Ceiling and Wall Mount Sensors provide precise control of lighting within a broad range of commercial and industrial applications. The sensor automatically turns the lights ON when an occupant enters the room and OFF when the space is unoccupied. LightOWL occupancy/vacancy sensors are an ideal solution for areas where traditional ceiling sensors are not suitable.

LightOWL sensors utilize smart IntelliDAPT® Technology to analyze the controlled area and make digital adjustments to both sensitivity and timing settings for optimal performance, energy savings, and maintenance-free, install-and-forget operation.

LIGHTOWL

LightOWL® Ceiling Mount Occupancy/Vacancy Sensors

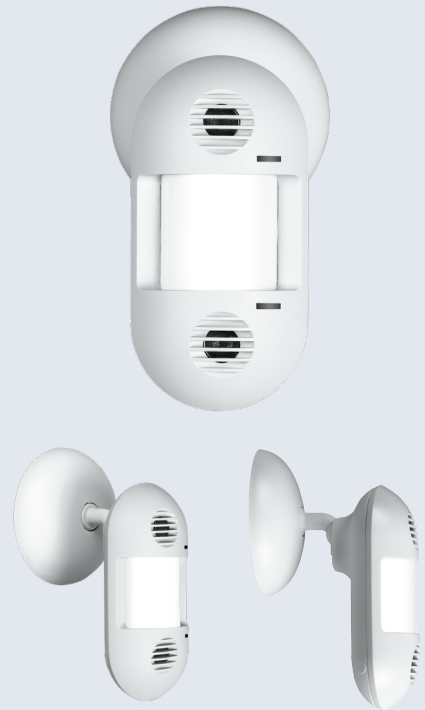

Features

- Ultrasonic (US) and Passive Infrared (PIR) technologies for unequaled motion detection
- Smart IntelliDAPT Technology eliminates false trigger
- Coverage: 1,600 square feet or 120 linear feet (depending on model)
- Optional relay and photocell control
- Five year warranty

Dimensions

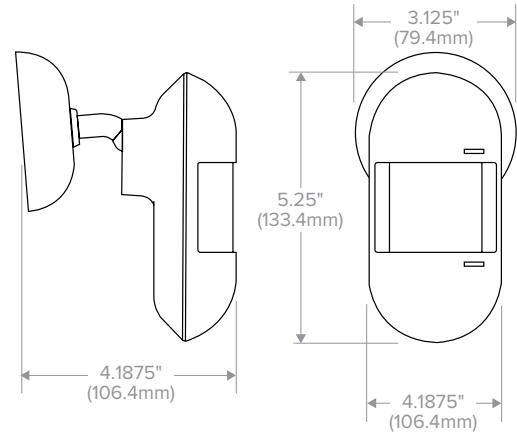

Accessories



Occupancy Sensor Accessories



Universal Voltage Power Packs

Available color options



Technology



Certifications



Controlled Receptacle



MP347A Power Pack



MPSHD Pack

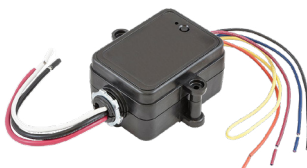

Heavy Duty Universal Voltage Power Packs



Ordering Information

LightOWL DT

LO	
MODEL	
LO	LightOWL Sensor

DT	
TECHNOLOGY	
DT	Dual Technology Ultrasonic and Passive Infrared

Ordering Example: LODT

RELAY/PHOTOCELL OPTION	
RP	Relay/Photocell
Blank	No Relay/Photocell

LightOWL IR

LO	
MODEL	
LO	LightOWL Sensor

TECHNOLOGY	
IRVV	Passive Infrared Wide View
IRHB	Passive Infrared High Bay

Ordering Example: LOIRWVRP

RELAY/PHOTOCELL OPTION	
RP	Relay/Photocell
Blank	No Relay/Photocell

LightOWL IRLWO

LO	
MODEL	
LO	LightOWL Sensor

TECHNOLOGY	
IRWVRP	Passive Infrared, Wide View Lens with Form C Contacts and Photocell

Ordering Example: LOIRWVRPLWO

ENVIRONMENT	
LWO	Outdoor Version

LIGHTHAWK

Maximize energy-savings while reducing maintenance costs by replacing standard switches with LightHAWK® Wall Mount Occupancy/Vacancy Sensors. LightHAWK sensors combine state-of-the-art technology to provide precise control of lighting loads within small to medium sized areas. With the choice of either Manual-ON (Vacancy Sensor) or Automatic-ON (Occupancy Sensor), these energy-saving sensors are designed to control a broad range of lighting fixtures and ensure that lights will turn OFF automatically when motion is no longer detected. All LightHAWK sensors are designed to fit in standard decorator style wall plates.

The LightHAWK Wall Switch Sensors feature superior motion detection utilizing passive infrared (PIR) and ultrasonic (US) sensing technologies. In addition to the standard ON/OFF versions, the LightHAWK sensors are available in dimming versions for additional energy savings with the convenience of 0-10V dimming. The dimming LightHAWK sensors can be set to come on at a predetermined level when occupied or to activate to the last-used dimming level, and allows continuous dimming using raise/lower buttons.

LightHAWK Sensors utilize smart IntelliDAPT® Technology to analyze the controlled area and make digital adjustments to both sensitivity and timing settings for optimal performance, energy savings, and maintenance-free, install-and-forget operation.

Applications



Small to Medium Offices



Utility Closets/Storage Areas



Small Conference Rooms



Break Rooms



Small to Medium Restrooms

LIGHTHAWK

LightHAWK® Wall Switch Occupancy/Vacancy Sensors



Available color options



Wiring Type



Single-Pole

Technology



Certifications



Features

- Ultrasonic (US) and Passive Infrared (PIR) technologies for exceptional motion detection
- Manual-ON (Vacancy Sensor) or Automatic-ON (Occupancy Sensor) operation
- Patented IntelliDAPT Technology maximizes energy savings
- 0-10V dimming versions available
- Built-in photo sensor for automatic daylight harvesting
- 400 - 1,000 square-foot coverage area depending on model
- Fits standard decorator wall plate
- Single or dual circuit control
- Five year warranty

Dimensions

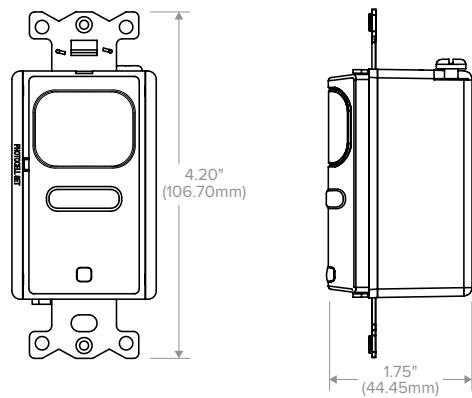

Accessories



Occupancy Sensor Accessories



Universal Voltage Power Packs



MPSHD Pack



MP347A Power Pack

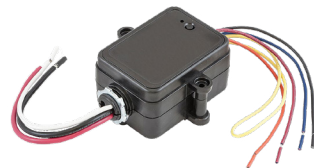

Heavy Duty Universal Voltage Power Packs

Ordering Information

LightHAWK Dual Tech Dimming

MODEL	WIRING	COLOR ¹	MODE
LHDMMTS2	Single Relay, Two Button	N Neutral (120/277V) N347 Neutral (347V)	Blank Switchable Vacancy or Occupancy Mode M ² Vacancy Mode Only

Ordering Example: LHDMMTS2-N-WH

LightHAWK Dimming

MODEL	WIRING	COLOR ¹	MODE
LHDMIRS3	Single Relay, Three Buttons	N Neutral (120/277V) N347 Neutral (347V)	Blank Switchable Vacancy or Occupancy Mode M ² Vacancy Mode Only

Ordering Example: LHDMIRS3-N-WH

LightHAWK Dual Tech

MODEL	WIRING	COLOR ¹	MODE
LHMTS0	Single Relay, No Button	G Ground (120/277V) N347 (120/277V)	Blank Switchable Vacancy or Occupancy Mode
LHMTS1	Single Relay, One Button	24V ³ Low Voltage	M ² Vacancy Mode Only
LHMTD0 ⁴	Dual Relay, No Button	G347 Ground (347V)	
LHMTD2 ⁴	Dual Relay, Two Button	N Neutral (347V)	
LHDCMTD0	Dual Circuit, No Button		
LHDCMTD2	Dual Circuit, Two Buttons		

Ordering Example: LHMTS1-N-WH

LightHAWK PIR

MODEL	WIRING	COLOR ¹	MODE
LHIRS0	Single Relay, No Button	G Ground (120/277V) N347 (120/277V)	Blank Switchable Vacancy or Occupancy Mode
LHIRS1	Single Relay, One Button	24V ³ Low Voltage	M ² Vacancy Mode Only
LHIRD0 ⁴	Dual Relay, No Button	G347 Ground (347V)	
LHIRD2 ⁴	Dual Relay, Two Button	N Neutral (347V)	
LHDCIRD0	Dual Circuit, No Button		
LHDCIRD2	Dual Circuit, Two Buttons		

Ordering Example: LHIRS1-G-WH

LightHAWK US

MODEL	WIRING	COLOR ¹	MODE
LHUSS0	Single Relay, No Button	G Ground (120/277V) N347 (120/277V)	Blank Switchable Vacancy or Occupancy Mode
LHUSS1	Single Relay, One Button	24V ³ Low Voltage	M ² Vacancy Mode Only
LHUSD0 ⁴	Dual Relay, No Button	G347 Ground (347V)	
LHUSD2 ⁴	Dual Relay, Two Button	N Neutral (347V)	
LHDCUSD0	Dual Circuit, No Button		
LHDCUSD2	Dual Circuit, Two Buttons		

Ordering Example: LHUSS1-G-WH

LHL Series

MODEL	BUTTONS	WIRING	COLOR ¹	MODE
LHL-IRS	LHL Series	1 1	G Ground (120/277V)	Blank Switchable Vacancy or Occupancy Mode M ² Vacancy Mode Only

Ordering Example: LHL-IRS1-G-WH

- 1 WH - White, IV - Ivory, LA - Light Almond, GY - Gray, BK - Black
- 2 Not available with No Button models
- 3 Requires UVPP or MP-series power pack, not included
- 4 Only available in 24V; Use LHDC for other voltages

Applications



Parking Garages



Area/Site Lighting



Cold Storage



Manufacturing



Warehouses



WASP

The HCS WASP, Dimming WASP and Bluetooth WASP are intelligent Passive Infrared (PIR) occupancy sensors. The occupancy sensing feature maximizes energy savings by turning lights off or going to preset dimmed settings to provide optimal safety and security for occupants in the area.

HCS WASP sensors can decrease energy consumption by utilizing daylight harvesting. These sensors have an integral photocell which allows for even more energy savings during daylight hours by turning off lights when there is sufficient natural light.

The WASP sensors support low and high mounting heights from 8' to 45' and feature multiple outputs and mounting options for versatility. The WASP sensors are ideal for a variety of applications such as parking garages, area/site lighting, pathways, warehouses, storage areas, stairwells and more.

WASP

WASP Occupancy Sensors



Features

- Passive Infrared (PIR) technology for superior motion detection
- Built-in photo sensor for automatic daylight harvesting
- Versatile lens options for broad coverage areas depending on model
- Weatherproof design is ideal for cold, humid, wet or dusty environments
- Works for indoor or outdoor applications
- Five year warranty

Dimensions

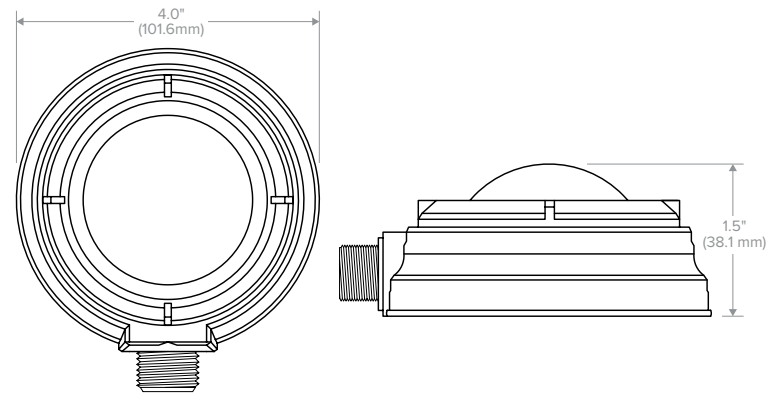

Available color options



Wiring Type

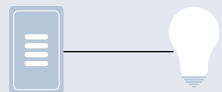

Single-Pole

Technology



Certifications



Accessories



Occupancy Sensor Accessories



Universal Voltage Power Packs



WASP Sensor Lens



MP347A Power Pack



MPSHD Pack

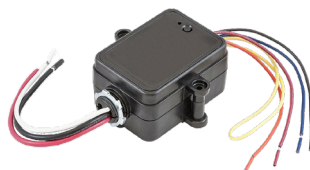

Heavy Duty Universal Voltage Power Packs



Ordering Information

Bluetooth WASP

WSPD				
MODEL	ENVIRONMENT	MOUNTING	INPUT VOLTAGE	COLOR
WSPD 0-10V Dimming WASP Sensor	B Standard Bluetooth® Version LWOB Low-Temp/Water Tight/Indoor/Outdoor with Bluetooth	EM End Mount SM Surface Mount	24V 24VDC (Low Voltage) UNV 120-480VAC	Blank White BK Black* GY Gray*

Ordering Example: WSPDBEMUNV, WSPDLWOBEMUNV-GY

Dimming WASP

WSPD				
MODEL	ENVIRONMENT	MOUNTING	INPUT VOLTAGE	COLOR
WSPD 0-10V Dimming WASP Sensor	Blank Standard Version LWO Low-Temp/Water Tight/Indoor/Outdoor	EM End Mount SM Surface Mount	24V 24VDC (Low Voltage) UNV 120-480VAC	Blank White BK Black* GY Gray*

Ordering Example: WSPDLWOEMUNV-BK

WASP

WSP				
MODEL	ENVIRONMENT	MOUNTING	INPUT VOLTAGE	COLOR
WSP	Blank Standard Version LWO Low-Temp/Water Tight/Indoor/Outdoor	EM End Mount SM Surface Mount	24V 24VDC (Low Voltage) UNV 120/277/347VAC UNV2R 120/277/347VAC (2 Outputs) 208 208/240VAC 480 480VAC	Blank White BK Black GY Gray

Ordering Example: WSPPEMUNV

*Made-to-Order, call factory for lead-times

PATENTED INTELLIDAPT® SELF ADAPTING TECHNOLOGY

IntelliDAPT Technology is a Hubbell Control Solutions’ patented innovation that delivers benefits to both building owners and occupants. The building owner achieves reduced energy costs, fewer adjustments and less maintenance while the building occupant experiences fewer false ON and OFFs and disturbances.

IntelliDAPT Technology occupancy sensors use microprocessors that make all the decisions for setting adjustments. Internal software constantly monitors the controlled area and automatically adjusts the sensitivity and timer based on environmental history. This means that instead of manually adjusting the sensor for seasonal changes, modified airflow, furniture layout or occupancy pattern changes, the sensor automatically adjusts itself. These automatic adjustments eliminate the need for multiple manual adjustments by maintenance personnel or outside contractors. HCS offers IntelliDAPT Technology throughout its product offering—wall switches, ceiling and wall mount sensors—in conjunction with dual technology, ultrasonic and passive infrared products.



Benefits:

- Adapts to space and needs
- Seasons
- Airflow
- Occupancy Patterns
- “Install-and-forget” operation
- Reduces false ON and OFFs

OCCUPANCY SENSOR WITHOUT SMART SENSING TECHNOLOGY

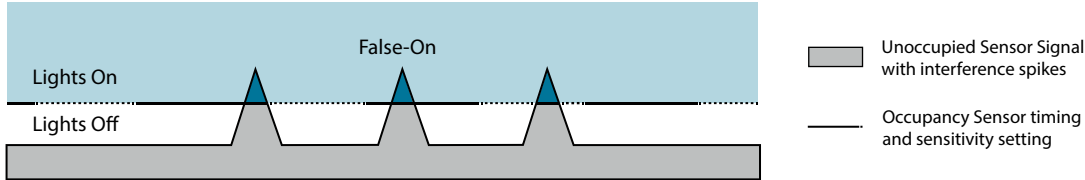

OCCUPANCY SENSOR WITH SMART SENSING TECHNOLOGY

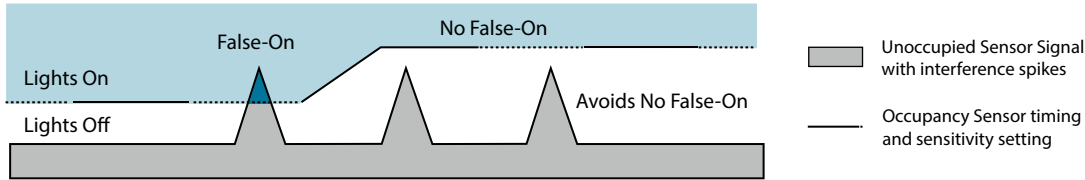



SELECT THE RIGHT TECHNOLOGY FOR THE PROPER APPLICATION

Hubbell Control Solutions' occupancy/vacancy sensors utilize passive infrared, ultrasonic and dual-technology for superior motion detection and cost-effective operations.

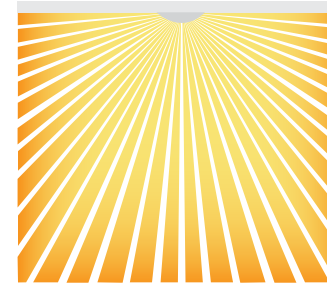

Passive Infrared (PIR)

Passive Infrared (PIR) technology senses occupancy by detecting the movement of heat emitted from the human body against the background space. Unlike Ultrasonic technology, PIR sensors require an unobstructed line-of-sight for detection. These sensors use a segmented lens which divides the coverage area into zones. Movement between zones is then interpreted as occupancy. PIR sensors are ideal for detecting major motion (ex. walking), and they work best in small, enclosed spaces with high levels of occupant movement.

Benefits:

- Long range detection
- Reliable triggering
- Cost efficient

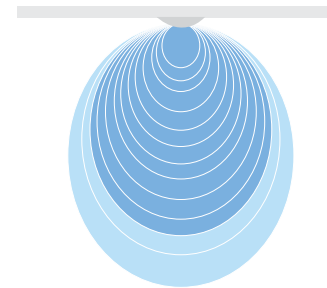

Ultrasonic (US)

Ultrasonic (US) technology senses occupancy by bouncing ultrasonic waves (32 kHz or 45 kHz) off of objects and detecting a frequency shift between the emitted and reflected waves. Movement by a person or object within a space causes a shift in frequency, which the sensor interprets as occupancy. While US occupancy sensors have a limited range, they are excellent at detecting even minor motion such as typing and filing, and they do not require an unobstructed line-of-sight. This makes US technology sensors ideal for an application like an office with cubicles or a restroom with stalls.

Benefits:

- Detect small motion
- Sees around obstructions

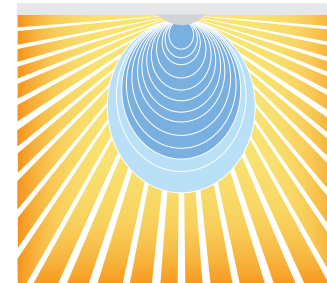

Dual Technology

Dual Technology occupancy sensors combine both Passive Infrared (PIR) and Ultrasonic (US) technologies for maximum reliability. Because US and PIR need to both detect occupancy to turn lighting on, Dual Technology sensors minimize the risk of lights coming on when the space is unoccupied—false triggering. Continued detection by only one technology then keeps lighting on as necessary. Dual technology sensors offer the best performance for most applications.

Benefits:

- Minimizes false triggering
- Consistent, reliable operation
- Virtually eliminates false offs

SOLUTIONS





OFFICE SOLUTIONS

Eliminate Energy Waste And Improve The Bottom Line

Companies have always had to make tough decisions regarding resource allocation. In the past, energy consumption was often treated as a fixed overhead cost. With new regulations and the need for sustainable building design, this no longer holds true. Lighting is responsible for much of an office's electricity use, and occupancy sensors can provide significant energy savings by providing light only where and when it's needed.

Enhance Reputation And Improve The Bottom Line

Companies with LEED-certified facilities have a higher standing within their communities and among industry peers. LEED-certified work environments also result in higher levels of employee satisfaction and retention due to healthier, brighter working conditions. HCS's sensors can help gain LEED points and illustrate a company's commitment to protecting the environment.

Energy Saving Locations:

- Closets
- Restrooms
- Break Rooms
- Conference Rooms
- Private Offices
- Open Offices
- Hallways
- Administration
- Stairways
- Exteriors

TYPICAL OFFICE ELECTRICITY USAGE AND SAVINGS*

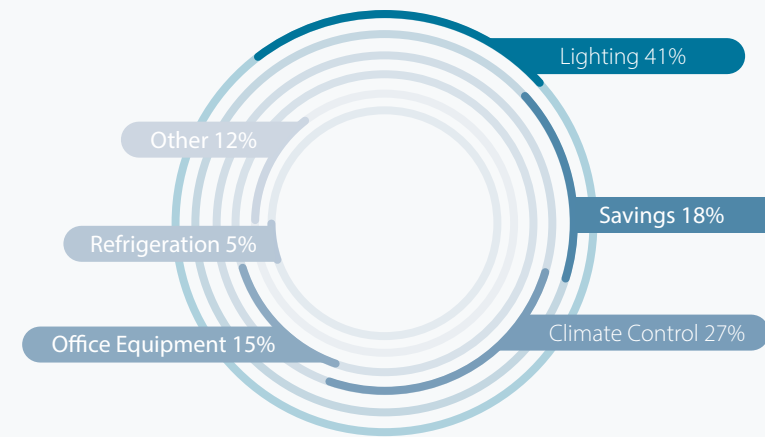

Lighting Uses 41% of Total Electricity

★ **Pro Tips:** Sensors with photocells provide additional savings in areas with natural light by turning off whenever possible.

APPLICATION ROI INDEX

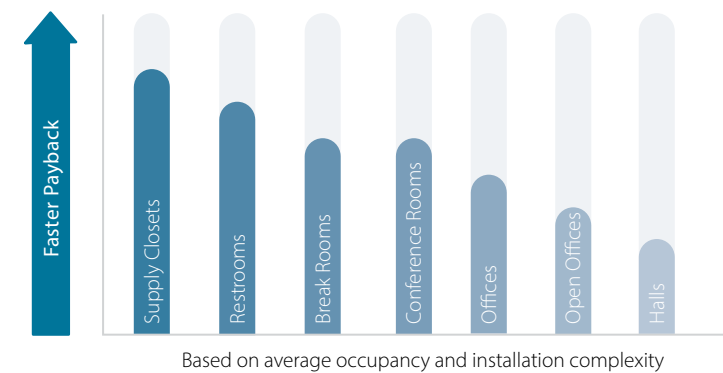

Success Factors:

- Reduce installation and maintenance labor by eliminating manual adjustments with adaptive sensors
- Maximize savings with HCS daylight harvesting products which precisely control lighting in response to available natural light
- Open office spaces provide many placement and product selection challenges.
- Contact your local HCS sensor professional for layout and product assistance

* Energy Information Administration: 2019 Commercial Buildings Energy Consumption Survey

** Based on 40% lighting savings from sensors.

Actual results may vary.



EDUCATION SOLUTIONS

Electricity Doesn't Educate - Teachers Do

Electricity bills are second only to payroll in today's restricted school budgets. Most of the electricity goes to keeping the lights on, even when they are not needed. Systematically turning lights off whenever possible significantly reduces a school's utility bill.

Regain Budget Control With HCS

HCS sensors provide a simple, automated and transparent system to make sure that lighting energy is used as needed. This protects school budgets from rate fluctuations, allowing educational institutions to more freely invest in teachers, programs and supplies that directly affect the quality of education.

Energy Saving Locations:

- Stairways
- Storage Rooms
- Restrooms
- Cafeterias
- Libraries
- Conference Halls
- Administration
- Classrooms
- Media Centers
- Hallways
- Gyms
- Auditoriums
- Exteriors

TYPICAL EDUCATION ELECTRICITY USAGE AND SAVINGS*

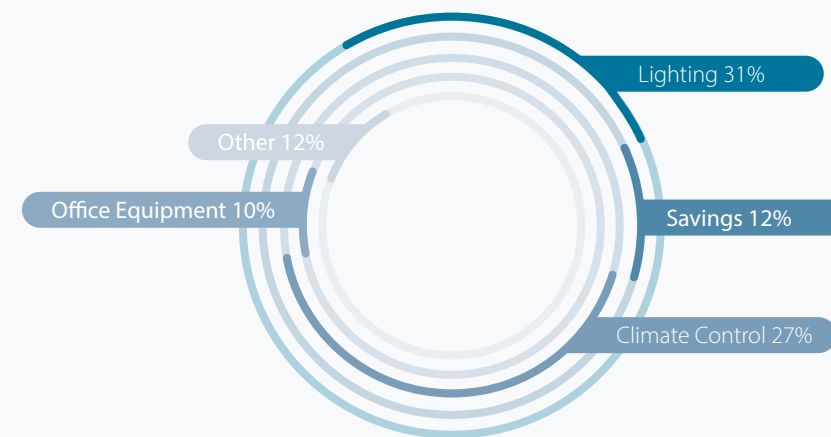

Lighting Uses 31% of Total Electricity

★ **Pro Tips:** Dual Technology sensors enhance minor motion detection reducing false situations during periods of reading or testing. Manual ON/OFF sensors provide control for movies and presentations.

APPLICATION ROI INDEX

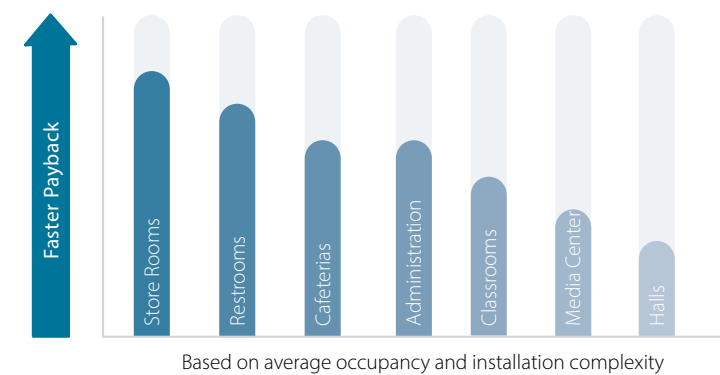

Success Factors:

- Provide advance lighting control of two zones for projector use with dual circuit switches
- Increase sensor longevity by specifying LHMT or LHIR series switch sensors with vandal resistant hard lenses or ultrasonic sensors
- Simplify retrofits by eliminating the need to run new wires by utilizing line voltage wall switch and ceiling sensors

* Energy Information Administration: 2019 Commercial Buildings Energy Consumption Survey

** Based on 40% lighting savings from sensors.

Actual results may vary.



HEALTHCARE SOLUTIONS

Turning Lights Off Should Be The Least Of Worries

Hospitals are a 24/7 operation where decisions and actions regarding the wellness of patients are critical. Consequently, lights are often left on when not needed. There are several areas throughout hospitals that can realize substantial efficiency improvements with little investment like administration offices, storerooms, closets and break rooms. Private practices, medical labs and outpatient care facilities have lower occupancy rates than hospitals and can further benefit from occupancy sensors.

Promote Healthier Environment

Light switches are one of the most commonly touched surfaces, spreading diseases and bacteria. Installing occupancy sensors where appropriate eliminates the need to touch a switch, which can help reduce the spread of pathogens. At the same time, healthcare staff benefit from a simple, user-friendly method of controlling the lights.

Energy Saving Locations:

- Store Rooms
- Restrooms
- Break Rooms
- Labs
- Exam Rooms
- Administration Offices
- Circulation
- Exteriors

TYPICAL HEALTHCARE ELECTRICITY USAGE AND SAVINGS*

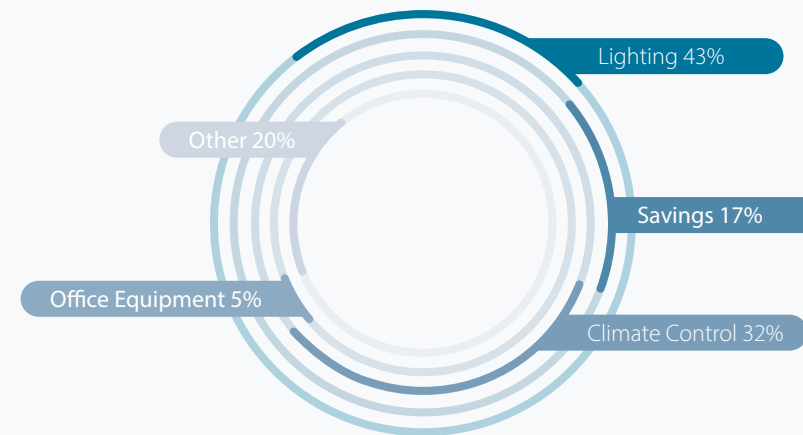

Lighting Uses 43% of Total Electricity

★ **Pro Tips:** IntelliDAPT® Technology will automatically adjust for changes in shifts, usage, and season eliminating the need for manual adjustments and improving system performance.

APPLICATION ROI INDEX

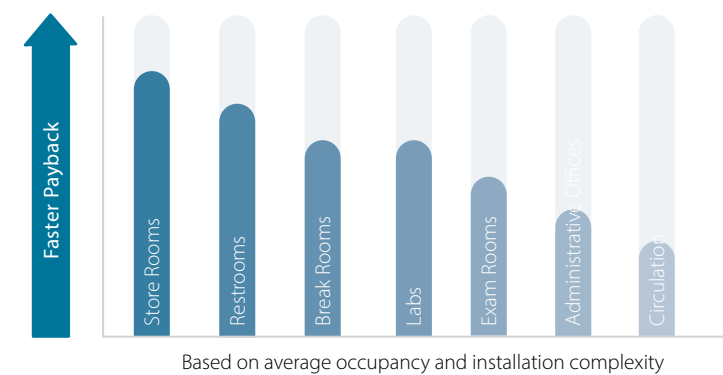

Success Factors:

- Prevent lights from coming on at night in patient rooms by setting LHMT, LHIR and LHUS series products to manual-ON mode
- Minimize privacy curtains and carts from preventing sensor activation by utilizing Dual Technology or Ultrasonic sensors
- Healthcare facilities have many special requirements and unique environments
- Contact your local HCS sensor professional for layout and product selection assistance

* Energy Information Administration: 2019 Commercial Buildings Energy Consumption Survey

** Based on 40% lighting savings from sensors.

Actual results may vary.



RETAIL SOLUTIONS

Illuminate Sales Potential And Increase Profits

Retail establishments use a significant amount of electricity for lighting—both for overhead and display. After all, customers need to clearly see what they're buying. However, there are numerous areas in stores that don't require light all day like stock rooms, restrooms, and fitting rooms. Occupancy sensors in these areas can lower a store's electricity bill and increase profit.

The Upgrade That Pays Back

HCS sensors provide an automated system that makes sure lights are turned on when needed and off when they're not. Employees can carry goods in and out of stock rooms without worrying about lights and patrons can enter instantly illuminated fitting rooms. Occupancy sensors also show customers that a retail establishment is committed to minimizing energy waste while saving money every day.

Energy Saving Locations:

- Stock Rooms
- Restrooms
- Changing Rooms
- Break Rooms
- Offices
- Hallways
- Show Floor
- Exteriors

TYPICAL RETAIL ELECTRICITY USAGE AND SAVINGS*

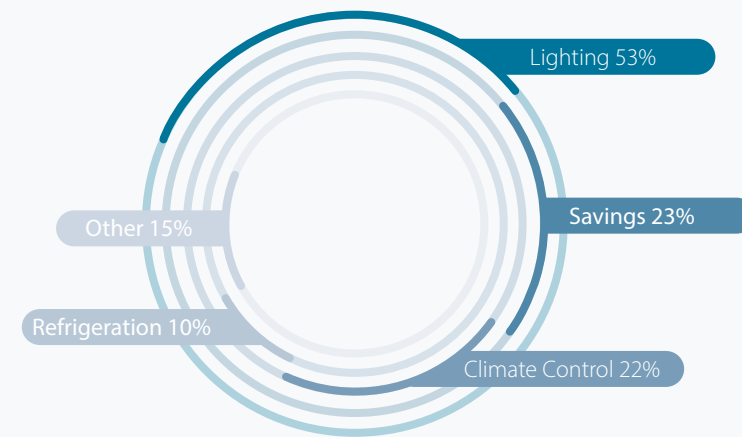

Lighting Uses 53% of Total Electricity

★ **Pro Tips:** Passive infrared is perfect for changing rooms, and break areas where ROI outweighs performance requirements.

APPLICATION ROI INDEX

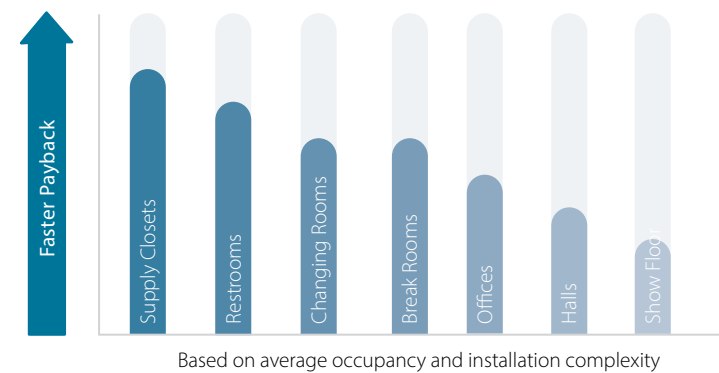

Success Factors:

- Minimize cost and maximize savings in changing rooms with PIR sensors and short off delays
- Reduce the chance for sensors damage by specifying LHMT or LHIR wall switch sensors with vandal resistant hard lenses
- Contact your local HCS sensor professional for assistance with high bay storage and show floor solutions

* Energy Information Administration: 2019 Commercial Buildings Energy Consumption Survey

** Based on 40% lighting savings from sensors.

Actual results may vary.



HOSPITALITY SOLUTIONS

Turn The Lights Off To Keep The Lights On

Over 50% of a hotel's electricity bill goes to keeping lights on, even when guests are away from their rooms. This results in substantial waste that reduces an establishment's financial efficiency and sustainability. With occupancy sensors, the waste can be eliminated without affecting customer comfort and convenience.

Manual-ON Mode Automates Savings

Hotel guests are on the go and often away from their rooms. As a result room lights are often left on, even in broad daylight. Specifically developed with the hospitality industry in mind, manual-ON mode provides guests with a traditional ON/OFF light control experience but then automatically turns off lights once a room is unoccupied for a period of time. This provides a simple and transparent method to ensuring that lights are off when necessary, significantly increasing a hotel's energy efficiency.

Energy Saving Locations:

- Supply Closets
- Break Rooms
- Food Service
- Restrooms
- Meeting Rooms
- Hallways
- Exercise Rooms
- Guest Rooms
- Exteriors

TYPICAL HOSPITALITY ELECTRICITY USAGE AND SAVINGS*

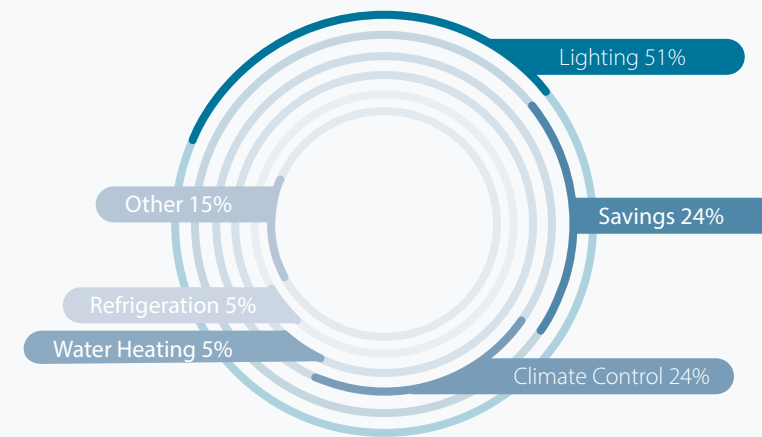

Lighting Uses 51% of Total Electricity

★ **Pro Tips:** Utilize Manual-ON setting to maximize savings by making sure lights are turned off when rooms are unoccupied while giving patrons a traditional ON/OFF experience.

APPLICATION ROI INDEX

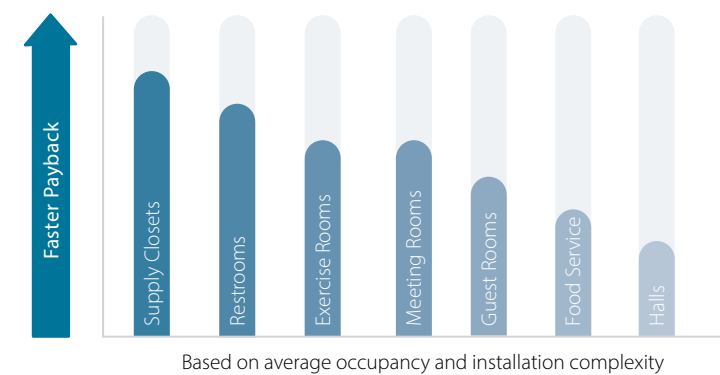

Success Factors:

- Let guests have traditional control by setting sensors to Manual-ON mode on LHIR, LHMT, and LHUS series products
- Utilize free sunlight to light your lobbies and atriums with HCS' atrium daylight harvesting sensor

* Energy Information Administration: 2019 Commercial Buildings Energy Consumption Survey

** Based on 40% lighting savings from sensors.

Actual results may vary.



WAREHOUSE SOLUTIONS

Reduce Energy And Operational Costs

Warehouse maintenance accounts for almost 10% of company's revenue, with heating and lighting being the two major energy consumers. Now that the old inefficient lights have been replaced by fluorescent and LEDs, facility managers increase lighting energy savings and install occupancy sensors. Occupancy sensors lower energy costs for warehouse spaces by turning lights on automatically when the motion is detected and then turning off when the area is vacated.

Control And Minimize Maintenance Costs

Significant utility savings are being missed in unoccupied warehouse areas as well as rooms fully lit by natural daylight. HCS's occupancy/vacancy sensors are specifically designed to maximize energy savings by turning lights ON and OFF based on occupancy. The sensors utilize daylight harvesting to provide optimal energy savings during daylight hours. Sensors can be mounted in a variety of ways including wall mount, ceiling mount, corner mount, surface mount or end mount.

Energy Saving Locations:

- Warehouse
- Restrooms
- Aisles
- Distribution Centers
- Store Rooms
- Offices
- Closets

TYPICAL WAREHOUSE ELECTRICITY USAGE AND SAVINGS*

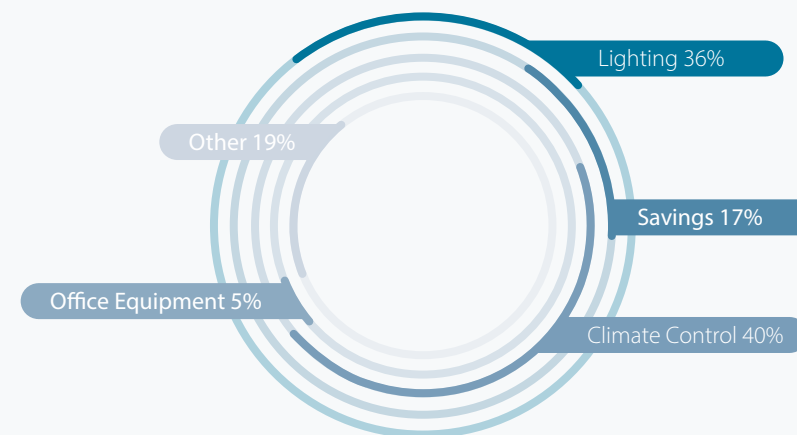

Lighting Uses 36% of Total Electricity

★ **Pro Tips:** Smart Cycling™ feature ensures that the amount of time each lamp is burned is maintained and kept balanced.

APPLICATION ROI INDEX

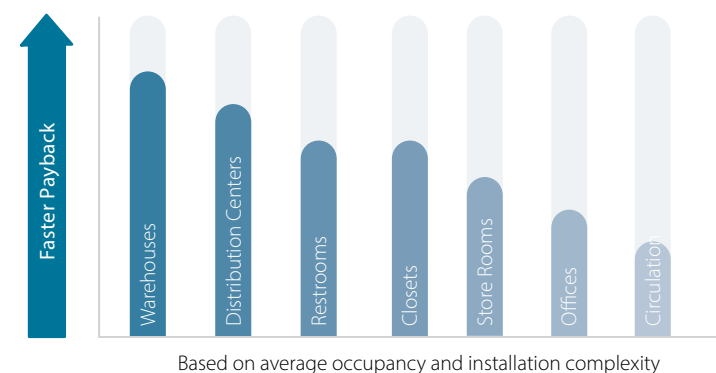

Based on average occupancy and installation complexity

Success Factors:

- Prevent lights from staying ON in unoccupied warehouse spaces
- Minimize energy usage in rooms illuminated by natural daylight
- Contact your local HCS sensor professional for layout and product selection assistance

* Energy Information Administration: 2019 Commercial Buildings Energy Consumption Survey

** Based on 40% lighting savings from sensors.

Actual results may vary.



OUTDOOR SOLUTIONS

Enhance Safety And Improve Operational Efficiency

Keeping outdoor areas safe is paramount to communities. Well-designed and well-maintained luminaires are costly and important assets for any outdoor or public installation. In the past, expensive labor and equipment were needed to ensure safety, beyond just energy costs. Hubbell Control Solutions' outdoor lighting sensors are the perfect solution for complete, cost-effective and code compliant control of outdoor lighting fixtures.

Take Control Of The Outdoors

Outdoor sensors effectively detect motion, and improve safety and performance over time. From parking lots to area lighting, the proven robustness and reliability of HCS's sensors provide cost-effective and flexible solutions that meet application requirements and energy codes, maximize energy savings and simplify outdoor lighting operations. Our sensors use a simple approach to control outdoor applications using PIR motion sensing, ON/OFF control, 0-10V dimming and wireless programming via HCS ControlHUBB Bluetooth App.

Energy Saving Locations:

- Parking Lot
- University Campus
- Roadway Lighting
- Parking Deck
- Airports
- Area Lighting

TYPICAL OUTDOOR ELECTRICITY USAGE AND SAVINGS*

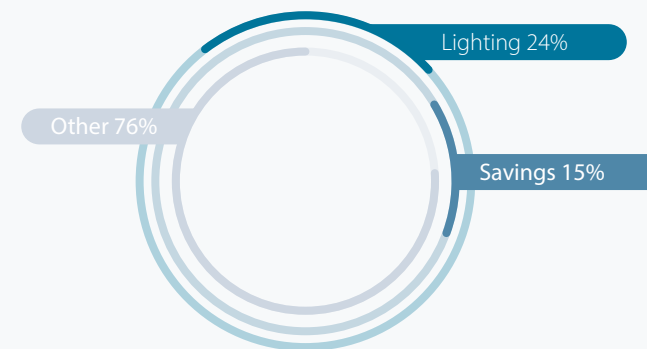

Lighting Uses 24% of Total Electricity

★ **Pro Tips:** Timers, dimmers and motion detection allow you to decide when lighting turns on and off.

APPLICATION ROI INDEX

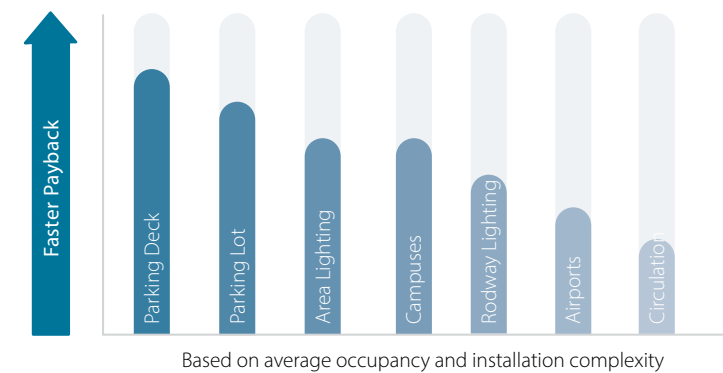

Success Factors:

- Energy and maintenance savings
- Provide enhanced public safety and security at night
- Contact your local HCS sensor professional for layout and product selection assistance

* Energy Information Administration: 2019 Commercial Buildings Energy Consumption Survey

** Based on 40% lighting savings from sensors.

Actual results may vary.

DESIGN GUIDE



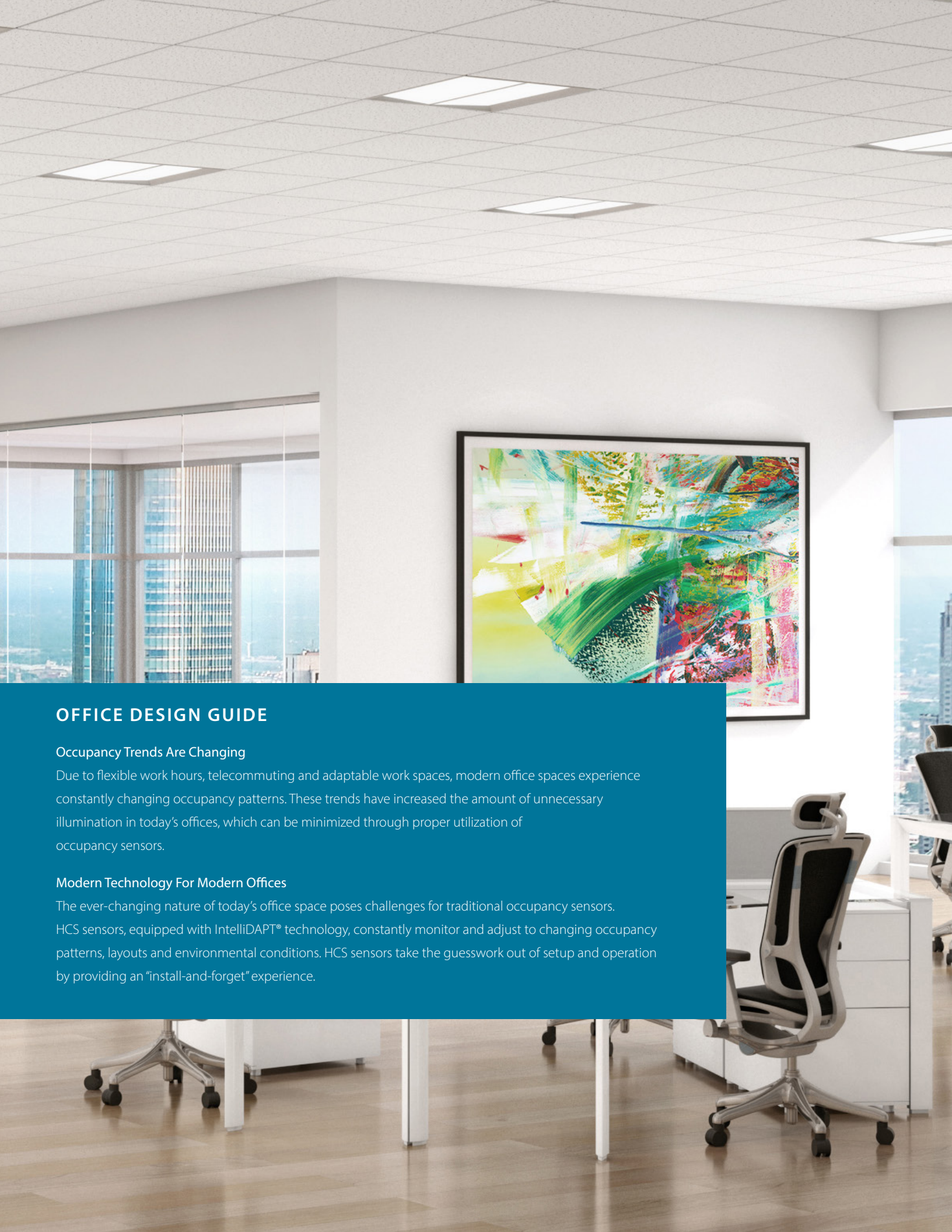

OFFICE DESIGN GUIDE

Occupancy Trends Are Changing

Due to flexible work hours, telecommuting and adaptable work spaces, modern office spaces experience constantly changing occupancy patterns. These trends have increased the amount of unnecessary illumination in today's offices, which can be minimized through proper utilization of occupancy sensors.

Modern Technology For Modern Offices

The ever-changing nature of today's office space poses challenges for traditional occupancy sensors. HCS sensors, equipped with IntelliDAPT® technology, constantly monitor and adjust to changing occupancy patterns, layouts and environmental conditions. HCS sensors take the guesswork out of setup and operation by providing an "install-and-forget" experience.

OPEN OFFICE

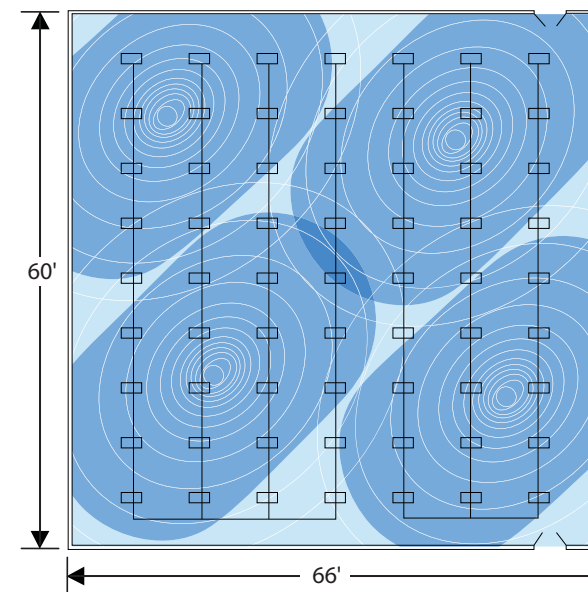

- | | |
|----------------------|----------------------|
| Major Motion: | Minor Motion: |
| ■ Ultrasonic | ■ Ultrasonic |
| ■ PIR | ■ PIR |

Technology

IntelliDAPT® Dual Technology (Recommended)

Suggested Installation

Position and angle sensors to maximize minor motion detection over work space concentrations. Make sure sensor is not obscured by an open door.

SMALL OFFICE

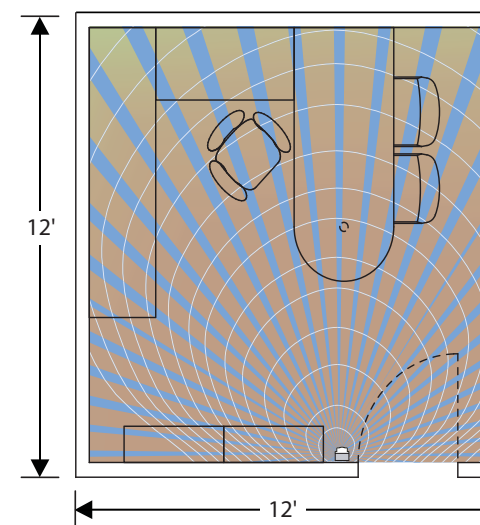

★ **Pro Tip:** Line voltage ceiling sensors simplify retrofits. Also note door location and swing radius to position wall switch sensors correctly.

LARGE OFFICE

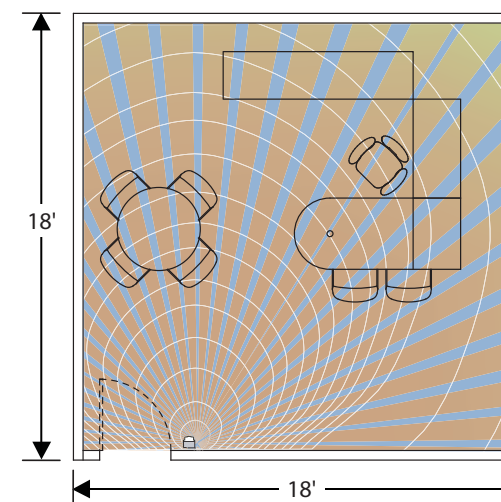

Recommended Products:



OMNIUS2000

- Ultrasonic technology
- IntelliDAPT self-adaptive technology
- 2,000 square-foot coverage area



LHMT Series

- Digital dual technology: (US) and (PIR) sensors
- IntelliDAPT self-adaptive technology
- 1,000 square-foot, 180° coverage area



CONFERENCE ROOM DESIGN GUIDE

Portraying The Right Image

The occupancy pattern of conference rooms makes these spaces ideal for HCS occupancy sensors. The use of photocell sensors ensures natural light is utilized when detected. Manual controls avoid lights coming on during audio-visual projection despite movement in the room. Because conference rooms are also often frequented by guests, they portray an image to meeting guests and attendees. No better image could be portrayed than a commitment to the environment through the use of occupancy sensors.

Energy Saving Locations:

- Large Boardrooms
- Small Boardrooms
- Training Rooms
- Teaming Areas

SMALL CONFERENCE ROOM

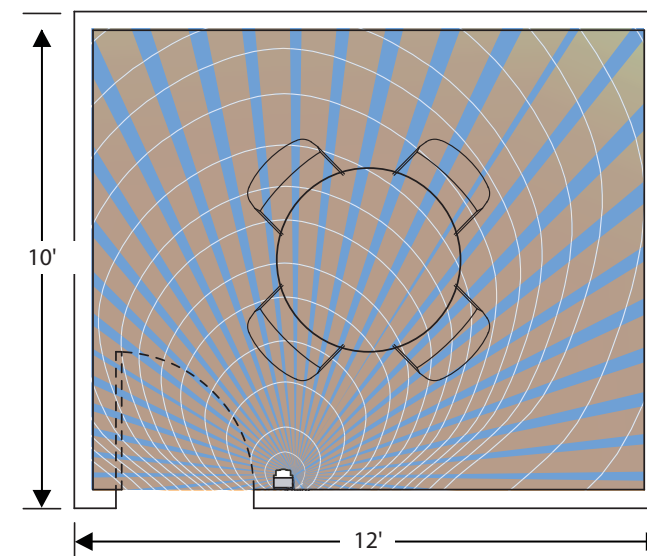

LARGE CONFERENCE ROOM

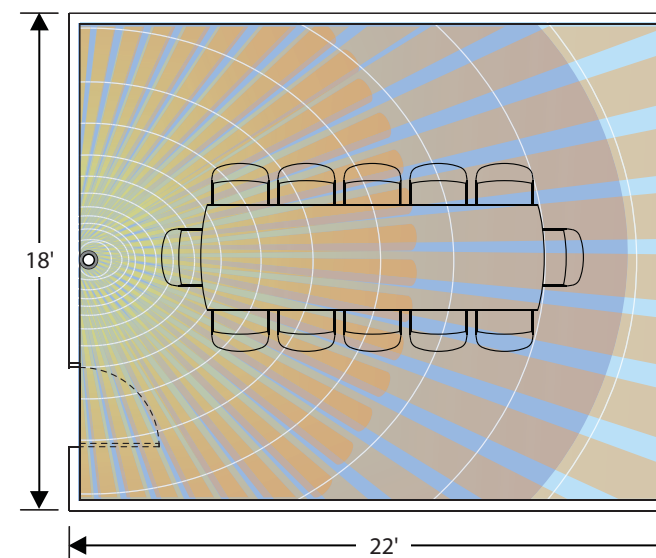

- Major Motion: Minor Motion:
- Ultrasonic ■ Ultrasonic
 - PIR ■ PIR

Technology

IntelliDAPT® Dual Technology (Recommended)

Suggested Installation for Small Conference Room

Make sure sensor is not obscured by presentation equipment like screens or easels

Suggested Installation for Large Conference Room

Dual circuit wall switches can be used to allow accent lighting during presentations if room size allows

- ★ **Pro Tips:** Line voltage ceiling sensors simplify retrofits. Also note door location and swing radius to position wall switch sensors correctly.
- Sensors with photocells provide additional savings in areas with natural light by turning off whenever possible.

Recommended Products:



OMNIDT1000

- Digital dual technology: (US) and (PIR) sensors
- IntelliDAPT self-adaptive technology
- 1,000 square-foot coverage area



LHMT Series

- Digital dual technology: (US) and (PIR) sensors
- IntelliDAPT self-adaptive technology
- 1,000 square-foot, 180° coverage area



CLASSROOM DESIGN GUIDE

HCS Sensors - The New Teacher's Pet

Classroom lighting consumes a substantial amount of the education budget. However, significant savings can be realized by turning off lights when they are not needed. Occupancy sensors provide an inexpensive way to guarantee that energy waste is kept to a minimum. They can further enhance savings by using optional photo sensors that turn off the lights when enough natural light is detected.

Design For Change

Classrooms are multi-use spaces that accommodate school-day activities and after school programs. Field trips, vacations, events and cancellations all affect occupancy patterns. At the same time, seasonal environmental conditions are always changing. HCS patented IntelliDAPT® Technology automatically adjusts to these changes to minimize inadvertent activation and maximize savings. HCS provides one of the most complete sensor lines for effectively managing project cost and performance in educational institutions.

LARGE CLASSROOM

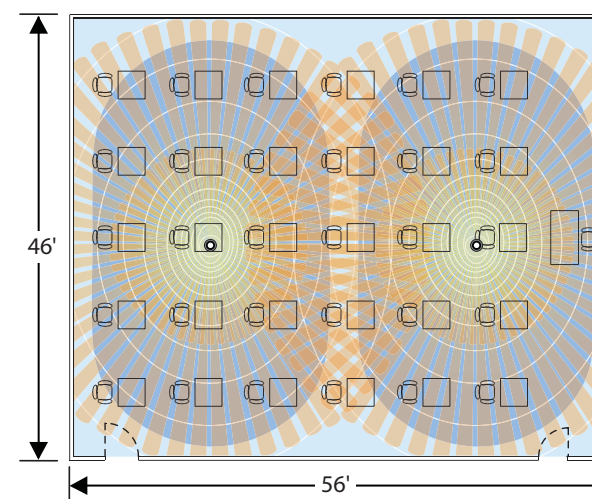

- | | |
|----------------------|----------------------|
| Major Motion: | Minor Motion: |
| ■ Ultrasonic | ■ Ultrasonic |
| ■ PIR | ■ PIR |

Technology for Large Classroom

IntelliDAPT® Dual Technology (Recommended)

Suggested Installation for Large Classroom

Provide teacher with manual override switches to turn off lights during A/V presentations

LIBRARY

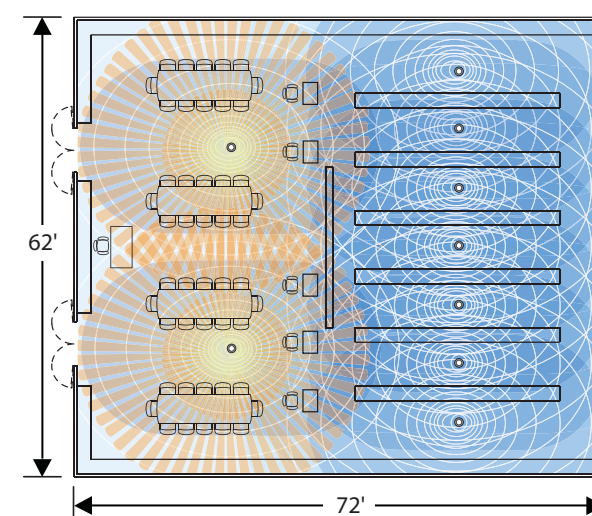

Technology for Library and Elementary Class

IntelliDAPT Dual Technology

(Recommended for sitting areas and classroom)

IntelliDAPT Ultrasonic Technology

(Recommended for browsing area and bathroom)

Suggested Installation for Library

Utilize ultrasonic sensors between book case stacks to eliminate blind spots

Suggested Installation for Elementary Class

Provide teacher with manual override switches to turn off lights for quiet times

LOWER GRADE ELEMENTARY CLASS

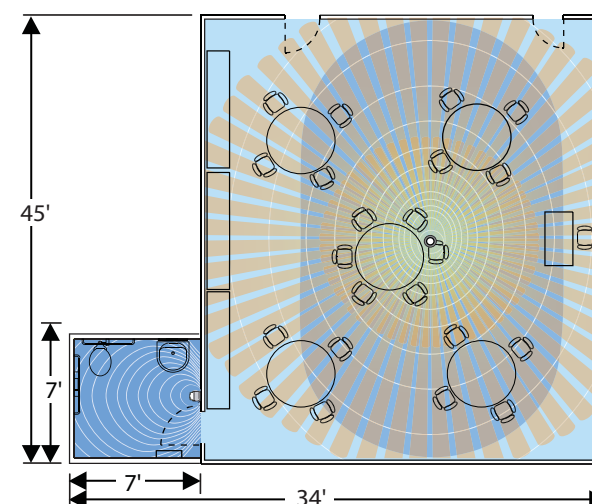

Recommended Products:



OMNIDT2000 | OMNIUS2000

- Ultrasonic (US) and Passive Infrared (PIR) technologies
- IntelliDAPT self-adaptive technology
- 2,000 square-foot coverage area



LHUS Series

- Ultrasonic technology
- IntelliDAPT self-adaptive technology
- 1,000 square-foot, 180° coverage area

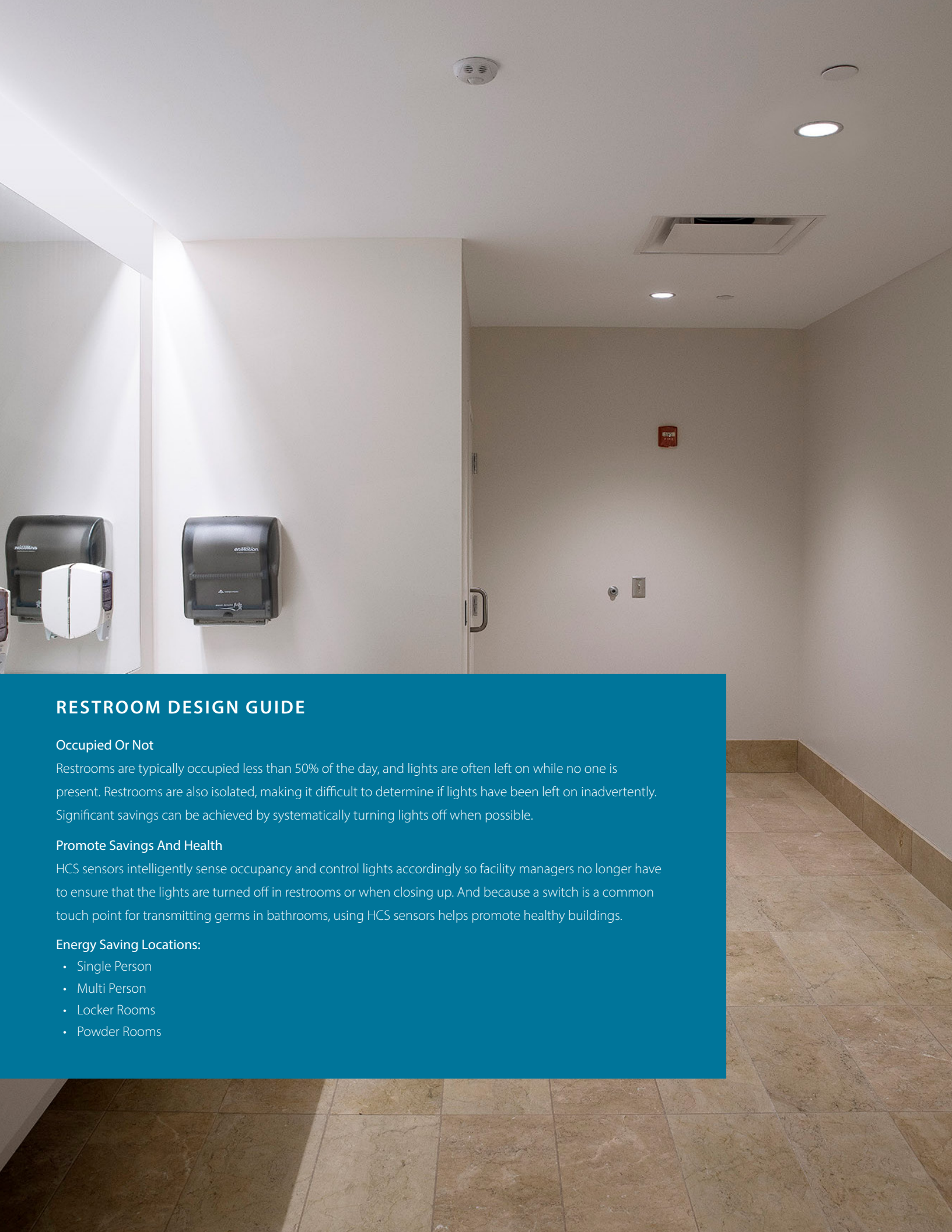

RESTROOM DESIGN GUIDE

Occupied Or Not

Restrooms are typically occupied less than 50% of the day, and lights are often left on while no one is present. Restrooms are also isolated, making it difficult to determine if lights have been left on inadvertently. Significant savings can be achieved by systematically turning lights off when possible.

Promote Savings And Health

HCS sensors intelligently sense occupancy and control lights accordingly so facility managers no longer have to ensure that the lights are turned off in restrooms or when closing up. And because a switch is a common touch point for transmitting germs in bathrooms, using HCS sensors helps promote healthy buildings.

Energy Saving Locations:

- Single Person
- Multi Person
- Locker Rooms
- Powder Rooms

SMALL SINGLE RESTROOM

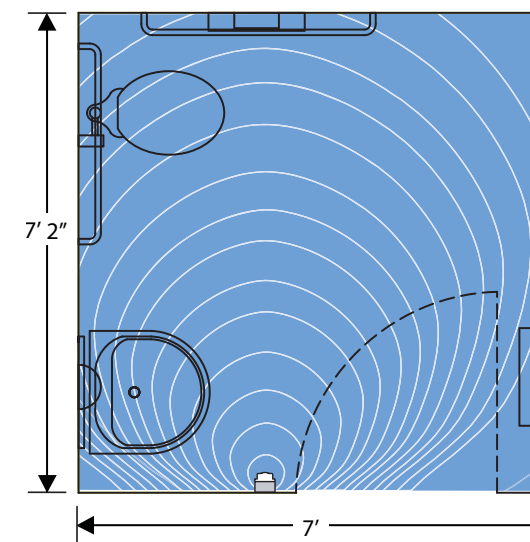

Major Motion: ■ Ultrasonic Minor Motion: ■ Ultrasonic

Suggested Installation for Small Restroom

Mount switch in location that limits chance for damage

Suggested Installation for Large Restroom

Place sensor closer to stalls to maximize minor motion detection

LARGER RESTROOM

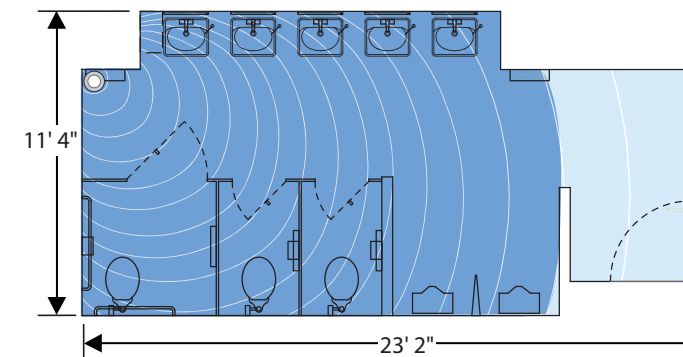

Suggested Installation for Large Restroom with Locker Room

Multiple sensors provide complete coverage and allow selective lighting based on occupancy

LARGE RESTROOM WITH LOCKER ROOM

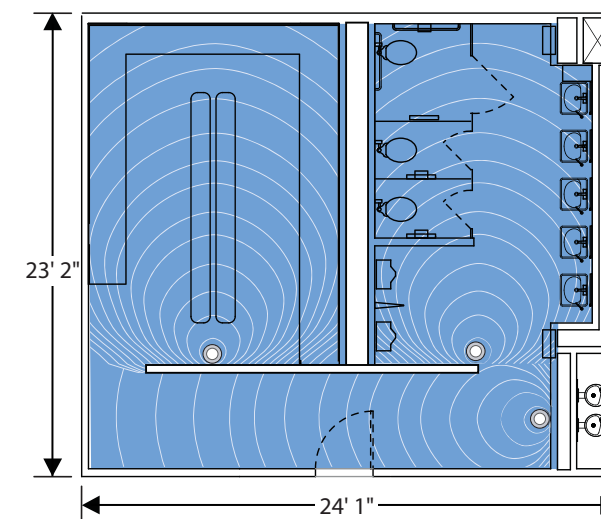

★ **Pro Tips:** Dual circuit sensors can allow for control of lights and exhaust fan simplifying installation*

Recommended Products:



OMNIUS500

- Ultrasonic technology
- IntelliDAPT self-adaptive technology
- 500 square-foot coverage area



LHUS Series

- Ultrasonic technology
- IntelliDAPT self-adaptive technology
- 1,000 square-foot, 180° coverage area

*Contact technical services regarding load and motor types supported



LABORATORIES DESIGN GUIDE

Labs Have Unique Requirements

Laboratory spaces are unique environments that have uncommon usage patterns and requirements, such as clean room classification. Lab technicians and scientists often have their hands occupied dealing with equipment, chemicals or biomaterials. In addition, occupancy constantly changes in labs. Even though lighting is often not needed for prolonged periods of time, lights are often left on.

Sensors - Clean And Efficient

HCS occupancy sensors provide a helpful way of automating energy savings. At the same time, they enhance the operation of the lab environment by allowing users to focus on their work instead of managing the lights. Ideal for the clean room environment, sensors have fewer moving parts that minimize foreign particulate generation and smooth surfaces that can be more easily cleaned. HCS's sensors not only save money, they provide a more efficient work environment.

Energy Saving Locations:

- Pharmaceutical Labs
- Quality Control Areas
- Product Development Labs
- Rapid Prototyping Shops

SMALL LABORATORIES

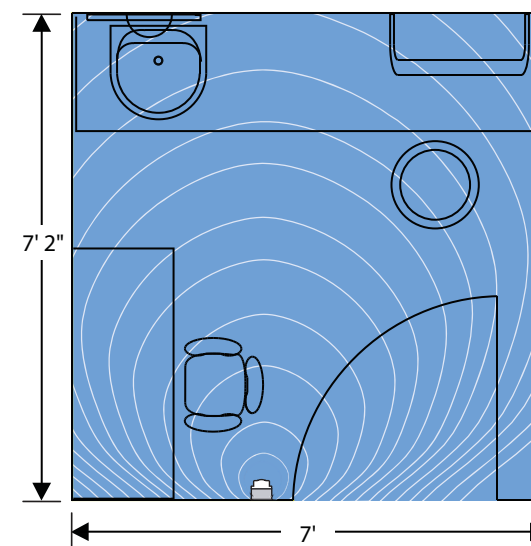

- | | |
|----------------------|----------------------|
| Major Motion: | Minor Motion: |
| ■ Ultrasonic | ■ Ultrasonic |
| ■ PIR | ■ PIR |

Suggested Installation for Small Laboratories

Utilize PIR to prevent detection of minor equipment motions

Suggested Installation for Large Laboratories

Determine equipment placement to position sensors accordingly. Multiple sensors may be required if large equipment is present

Suggested Installation for Computer Lab

Centering sensor over the seating area maximizes detection of minor motion like typing

LARGER LABORATORIES

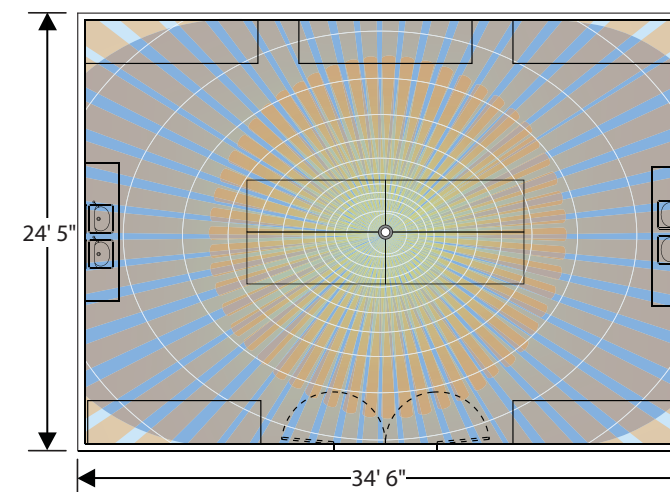

★ **Pro Tip:** Use Dual Technology or Ultrasonic in labs with obstructions such as large filing cabinets or air flow hoods

COMPUTER LAB

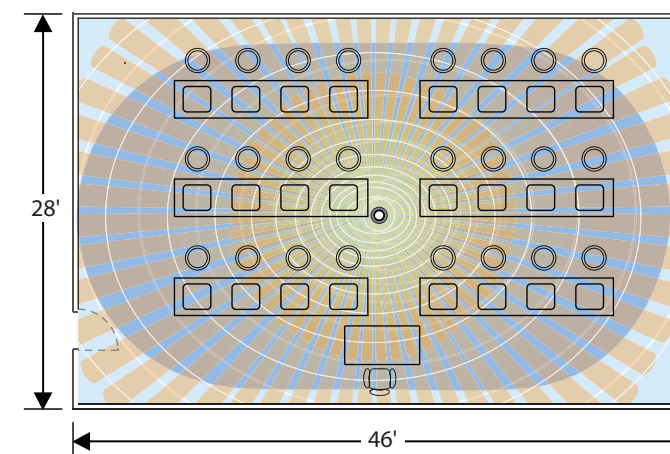

Recommended Products:



OMNIUS2000 | OMNIDT2000

- Ultrasonic (US) and Passive Infrared (PIR) technologies
- IntelliDAPT self-adaptive technology
- 2,000 square-foot coverage area



LHUS Series

- Ultrasonic technology
- IntelliDAPT self-adaptive technology
- 1,000 square-foot, 180° coverage area



STORAGE AREA DESIGN GUIDE

Frequently Forgotten

Closets and storerooms offer one of the best environments for occupancy savings due to intermittent use. Furthermore, people leaving these spaces are often carrying supplies or merchandise, making turning off lights difficult. People then move on to the task at hand. Going back to turn off lights is frequently forgotten. Like restrooms, closets and storerooms are normally isolated, and it's difficult to determine if lights have been left on.

Easy In, Easy Out

With occupancy sensors, entering or leaving a storeroom with hands full is easily accomplished without worrying about the lights staying on and wasting energy. HCS' breadth of products includes occupancy sensors with passive infrared technology that are ideal for small spaces of major movement, as well as options for covering large warehouse aisles and high-bay applications with 120-foot linear coverage.

Energy Saving Locations:

- Warehouses
- Supply Closets
- Utility Closets
- Network Closets

SMALL CLOSET/STOREROOM

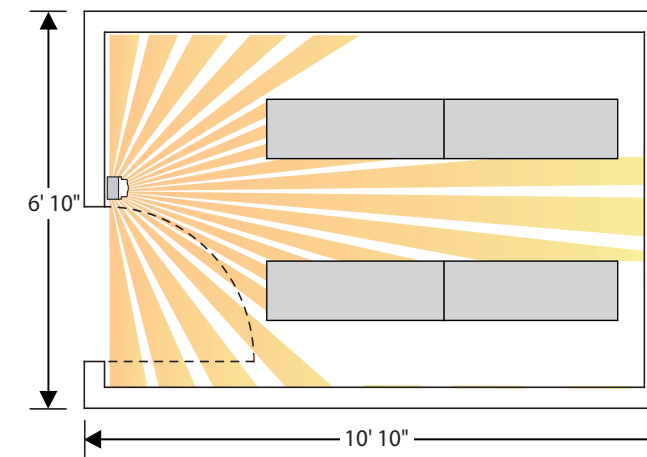

LARGER RESTROOM

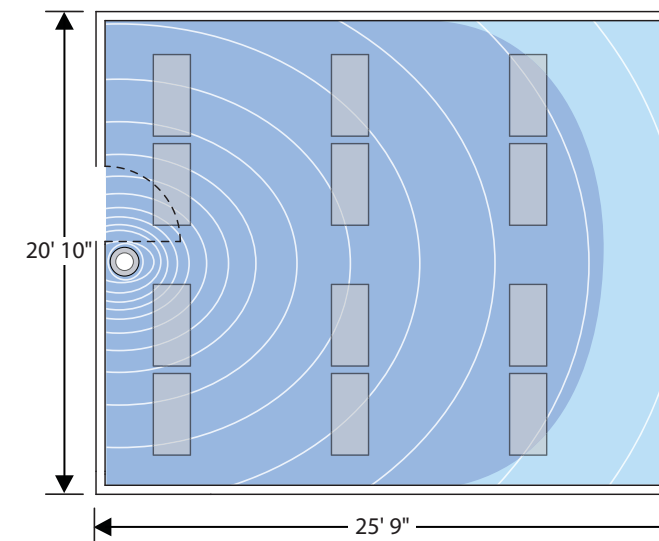

WAREHOUSE

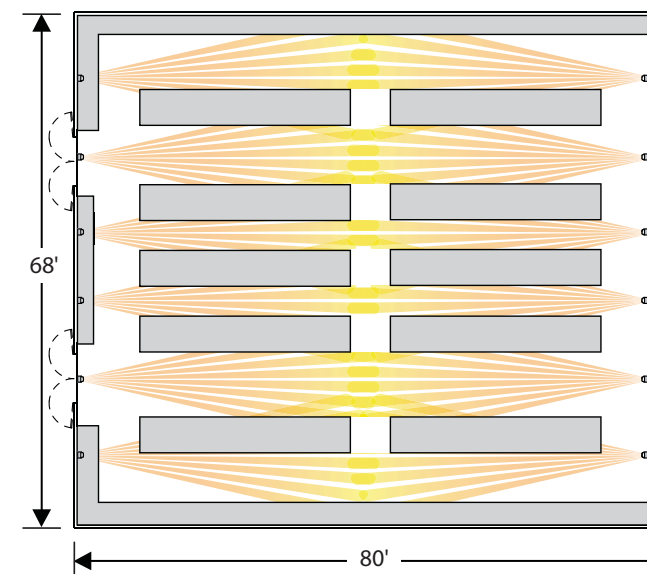

- Major Motion: Minor Motion:
- Ultrasonic ■ Ultrasonic
 - PIR ■ PIR

Technology for Small Closet/Storeroom and Warehouse
Passive Infrared IntelliDAPT® Technology (Recommended)

Technology for Large Closet/Storeroom and Warehouse
IntelliDAPT Dual Technology (Recommended)

Suggested Installation for Small Closet/Storeroom
Position sensor close to door to make sure lights come on when the door is opened.

Suggested Installation for Large Closet/Storeroom
Use a wall mount sensor if ceiling height is above 12ft

Suggested Installation for Warehouse
Utilize fixture mount high bay sensors in larger areas or where wall sensors are not feasible

★ **Pro Tips:** Set short delays for small supply closets and store rooms to maximize savings

Recommended Products:



- OMNIUS | OMNIUS1000**
- Ultrasonic technology
 - IntelliDAPT self-adaptive technology
 - 1000 square-foot coverage area



- WASP**
- Digital Passive Infrared (PIR) sensor
 - End mount and surface mount versions
 - High Mount and Low Mount lenses sold separately



BACKED BY HCS SERVICE AND SUPPORT

Backed by HCS Service and Support

HCS Occupancy Sensors are backed by Hubbell Control Solutions' superior service and support including:

- Valuable online ROI worksheet for calculating energy savings
- Product selection guide for choosing the right HCS Occupancy Sensor and technology
- Online specification assistance through AutoCAD drawings, templates and documentation
- Comprehensive design assistance for deploying occupancy sensors in a variety of applications with guaranteed layouts
- Highly knowledgeable network of specification professionals and trained, dedicated sales staff
- Sustainable: Backed by Hubbell, committed to safeguarding the environment through innovative products and efficient operations

For more information about Hubbell Control Solutions and access to our complete suite of on-line tools, visit our website at www.hubbellcontrolsolutions.com.

Layout Capabilities and Technical Support

HCS representatives are available to answer all your questions and discuss any project—large or small. Sensor selection and layout services are available. Call 888-698-3242 for more info or chat with us on our website.



COMPREHENSIVE SUPPORT OPTIONS TO MEET PROJECT NEEDS



Phone and Online Support

While it is our goal to provide you with intelligent, simple and scalable control solutions, customer experience level and project complexity may necessitate additional support during the design development, construction and post-occupancy stages of a project.

The Hubbell Control Solutions support team is available for consultation to evaluate multiple control scenarios to identify the ideal lighting control device or system to meet energy code requirement and customer criteria. Additionally, our team of friendly and experienced professionals is enabled to assist on-site personnel, such as installation contractors, third party integrators, certified field technicians and facilities personnel, to quickly resolve issues and provide additional support.



Design Service

Our team of lighting control system design professionals are available to provide sensor layouts, networked system design services and third party integration support for new and retrofit projects. Our goal is to provide you with on-time and accurate delivery of design deliverables optimized for your specific application, compliant with local building codes and project specifications.



On-site Support

Hubbell Control Solutions offers on-site support service to ensure your project goes smoothly. While Hubbell Control Solutions products are designed with simplicity in mind, some projects may benefit from a Field Service Engineer to perform an on-site pre-installation walk-through, after-hours and remote startup assistance, occupant training, sensor tuning, preset programming and other pre/post-occupancy services.



Warranty

Hubbell Lighting provides a 5-year limited warranty for LED luminaires and Hubbell Control Solutions devices.



Technical Service Center | (800) 888-8006



ALERA LIGHTING

ARCHITECTURAL AREA LIGHTING

BEACON PRODUCTS

COLUMBIA LIGHTING

COMPASS

DUAL-LITE

HEALTHCARE SOLUTIONS

HUBBELL CONTROL SOLUTIONS

HUBBELL INDUSTRIAL LIGHTING

HUBBELL OUTDOOR LIGHTING

KIM LIGHTING

KURT VERSEN

LITECONTROL

PRESCOLITE

HUBBELL®
Control Solutions

701 Millennium Blvd. Greenville, SC 29607

Tel 864.678.1000

www.hubbellighting.com

HCS18000075 03/2020

Copyright © 2020 Hubbell Lighting, Inc. All rights reserved. Please refer to online specifications for most up-to-date content as specifications are subject to change without notice.