



PART No. HW423612GYHK

for more information visit
www.hammondmfg.com

Data subject to change without notice

Isometric drawing Not to Scale

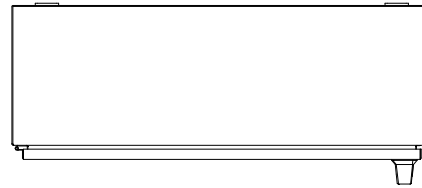

TOP VIEW

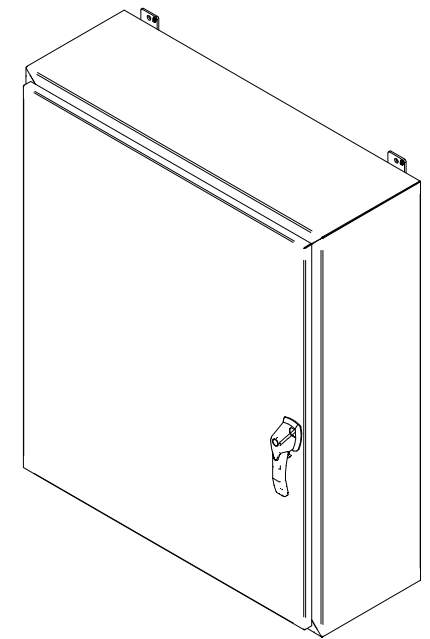

ISOMETRIC VIEW

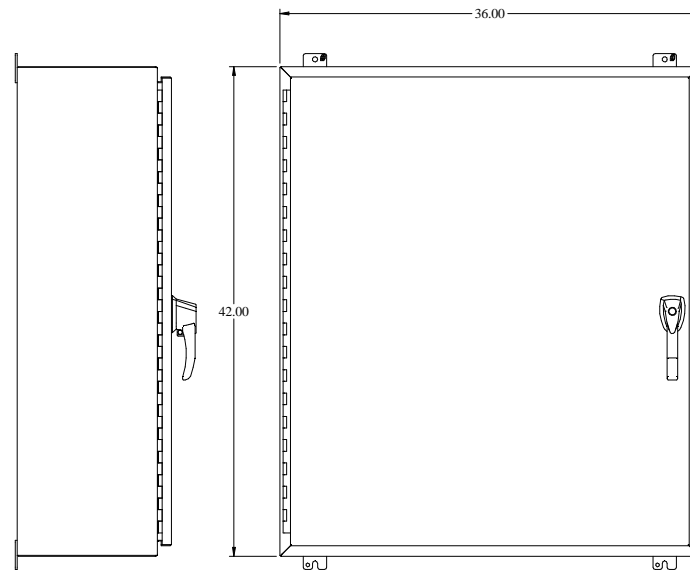

SIDE VIEW

FRONT VIEW

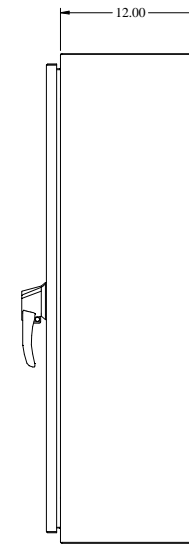

SIDE VIEW

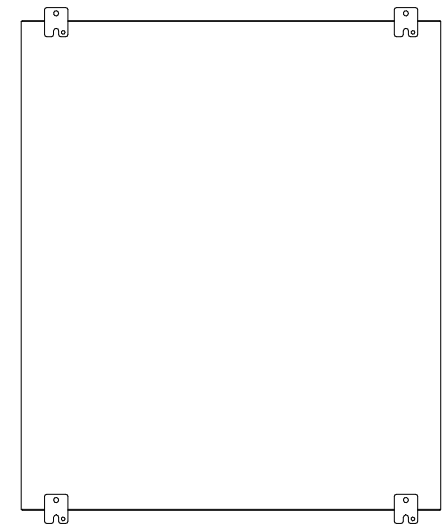

REAR VIEW



BOTTOM VIEW