

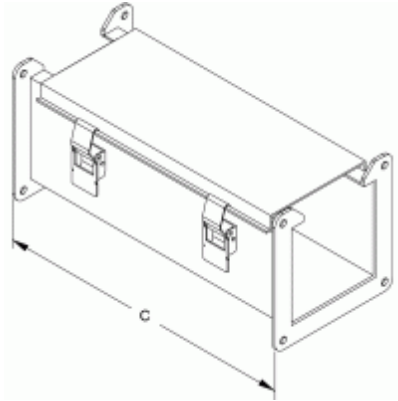

Quality Products. Service Excellence.

Typical Straight Section 1485 S Series



Description	Sealing Plates Supplied	2.5 x 2.5 Part No.	4 x 4 Part No.	6 x 6 Part No.	8 x 8 Part No.	12 x 6 Part No.
6" Section	1 Flat	1485B6	1485C6	1485D6	1485E6	1485F6
12" Section	1 Flat	1485B12	1485C12	1485D12	1485E12	1485F12
24" Section	1 Flat	1485B24	1485C24	1485D24	1485E24	1485F24
36" Section	1 Flat	1485B36	1485C36	1485D36	1485E36	1485F36
48" Section	1 Flat	1485B48	1485C48	1485D48	1485E48	1485F48
60" Section	1 Flat	1485B60	1485C60	1485D60	1485E60	1485F60
120" Section	1 Flat	1485B120	1485C120	1485D120	1485E120	1485F120



Data subject to change without notice

© 2021. Hammond Manufacturing Ltd. All rights reserved.