

ASSEMBLY - VIEW FROM FRONT

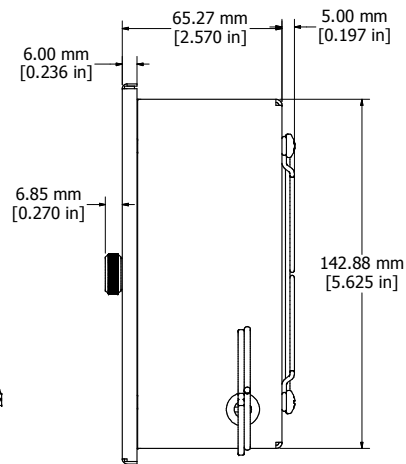

ASSEMBLY - VIEW FROM SIDE

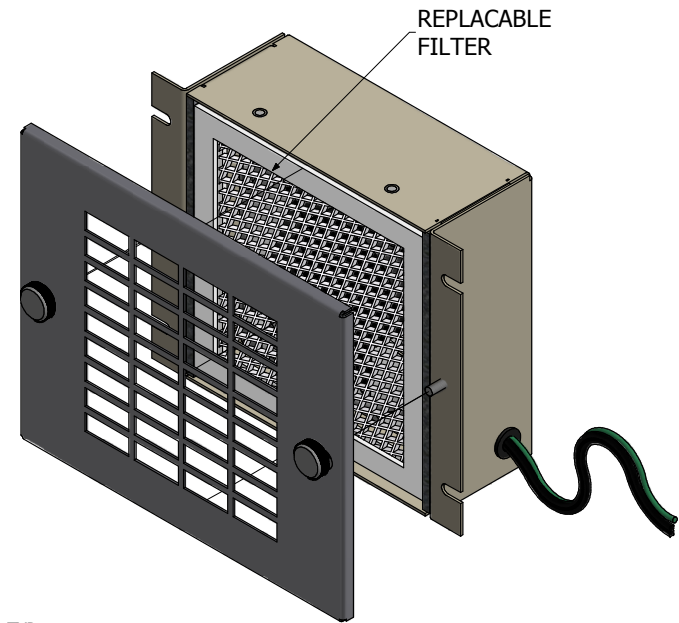

EXPLODED ASSEMBLY VIEW

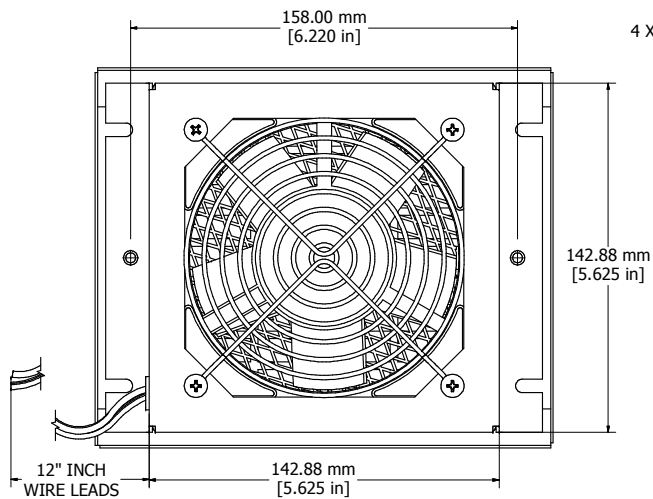

ASSEMBLY - VIEW FROM BACK

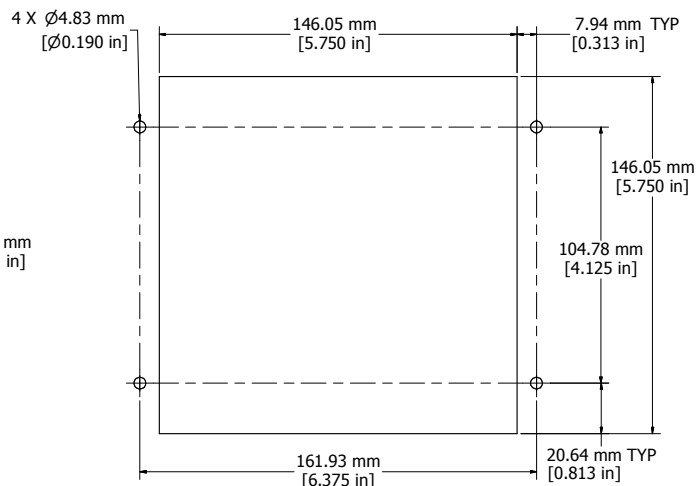

FAN BOX CUTOUT

XF4115 & XF4230
Finish - Front Screen - Polished Stainless Steel
- Case - Painted Grey Steel
Rated - 115 VAC, 50/60 Hz, 0.24 Amps
- 230 VAC, 50/60 Hz, 0.13 Amps
Free Flow Air Delivery - 105 CFM
ACCESSORIES
Replacement Filter - XFF4 (Package of 3)

