

## ORDERING INFORMATION

Order code: 62924  
 Description: BHPS0150/TRITAP/C/HX/H/K/STD  
 UPC: 69549629240

## SPECIFICATIONS

Ballast type: Magnetic high pressure sodium  
 Ballast style: Core and coil  
 Circuit type: HX-HPF  
 ANSI code: S55  
 Input voltage (V): 120/277/347  
 Input frequency (Hz): 60  
 Line volt regulation: 10 %  
 Line watt regulation: Within trapezoid  
 Insulation class: H (180)

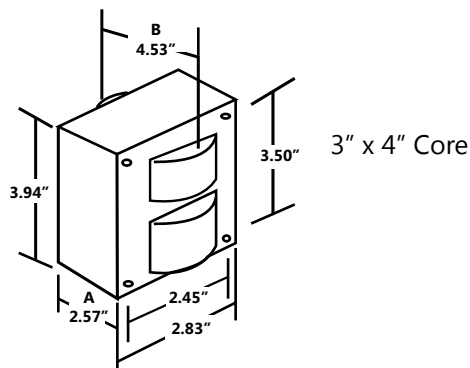
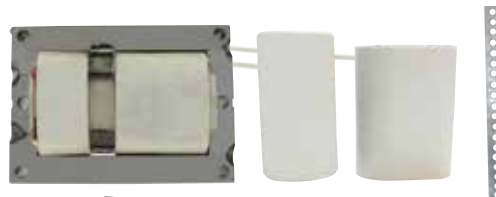

Input voltage (V)	Operating current (A)	Open circuit current (A)	Starting current (A)	Rated lamp watts (W)	Input watts (W)	OCV (V)	Dropout voltage (V)	UL 1029 code	Fuse rating (A)	Input current (A)	Power factor	Starting temperature
120	1.65	3.00	2.00	150	188	120	95	D	10	1.00 - 1.50	0.90	-20°F / -30°C
277	0.75	1.30	0.85	150	188	120	222	D	4	0.45 - 0.70	0.90	-20°F / -30°C
347	0.56	1.05	0.55	150	188	120	280	D	3	0.35 - 0.60	0.90	-20°F / -30°C

## HIGH POTENTIAL TEST (V)

1 minute:	2 000
2 seconds:	2 500
OCV test:	110 - 130
Short circuit:	3.20 - 4.60

## BALLAST DIMENSIONS

Dimension A:	2.57"
Dimension B:	4.53"
Lead lengths:	12" - 14"
Weight (lbs):	7.94

## WIRING DIAGRAM

Ground ballast core

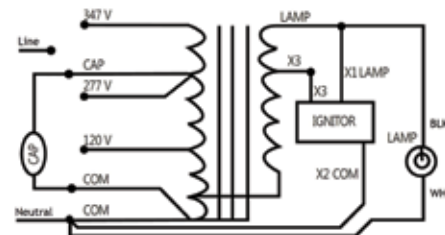

## BRACKET

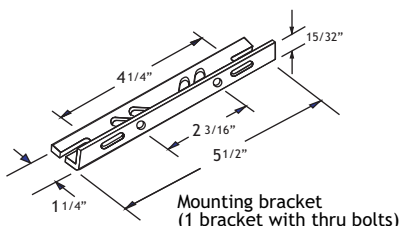

## CAPACITOR

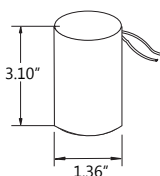

Rating: 14 ± 3% Mfd  
 280 VAC min.  
 Dry film capacitor  
 Thermal plastic  
 Max. case temp.: 90 °C  
 No PCB'S

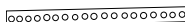

## IGNITOR

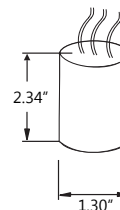

Ballast to lamp distance (BTL): 10'  
 Thermal plastic  
 Max. case temp.: 105 °C

