

## Universal Device Mount Covers

### Single Gang



S310E-R



CCD / WR81-CN

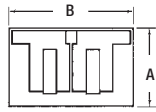

S305 / CCG / CCG-L / DCCG-BR / DCCG-WH

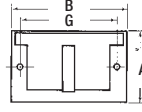

CCS / CCS-L

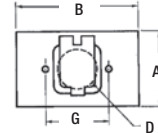

Cat. No.	Description	A (in.)	B (in.)	D (in.)	G (in.)
<b>Single Gang Device Mount Covers – Horizontal (zinc)</b>					
S310BRE	For duplex receptacle – Bronze	2-27/32	4-9/16	–	–
S310E-R	For duplex receptacle – Silver	2-27/32	4-9/16	–	–
S310WHE	For duplex receptacle – White	2-27/32	4-9/16	–	–
CCD-L	For duplex receptacle with lock option	2-27/32	4-9/16	–	–
WR81-CN	Natural cover with stay open lid	2-27/32	4-9/16	–	–
WRMB-87	Cover, motor base with device	2-27/32	4-9/16	–	–
DCCDSO	For duplex receptacle with lock option stay open – Silver	2-27/32	4-9/16	–	–
S305BRE	For GFCI receptacle – Bronze	2-27/32	4-9/16	–	3-13/16
S305E	For GFCI receptacle – Silver	2-27/32	4-9/16	–	3-13/16
S305WHE	For GFCI receptacle – White	2-27/32	4-9/16	–	3-13/16
CCG	GFCI receptacle box cover	2-27/32	4-9/16	–	3-13/16
CCG-L	GFCI receptacle box cover with lock option	2-27/32	4-9/16	–	3-13/16
CCS	For single receptacle, horizontal	2-13/16	4-9/16	1-1/2	2-3/8
CCS-L	For single receptacle, horizontal with lock option	2-13/16	4-9/16	1-1/2	2-3/8
DCCG-BR	GFCI receptacle, horizontal – Bronze	2-27/32	4-9/16	–	3-13/16
DCCG-WH	GFCI receptacle, horizontal – White	2-27/32	4-9/16	–	3-13/16



S309 / CCDV-L



S306 / CCGV-L / CCGV

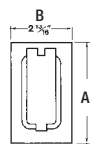

CCSV / CCSV-L

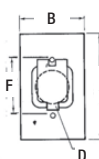

Cat. No.	Description	A (in.)	B (in.)	D (in.)	F (in.)
<b>Single Gang Device Mount Covers – Vertical (zinc)</b>					
S309BRE	For duplex receptacle – Bronze	4-9/16	2-13/16	–	–
S309E	For duplex receptacle – Silver	4-9/16	2-13/16	–	–
S309WHE	For duplex receptacle – White	4-9/16	2-13/16	–	–
CCDV-L	For duplex receptacle with lock option	4-9/16	2-13/16	–	–
S306BRE	For GFCI receptacle – Bronze	4-9/16	2-13/16	–	–
S306E	For GFCI receptacle – Silver	4-9/16	2-13/16	–	–
S306WHE	For GFCI receptacle – White	4-9/16	2-13/16	–	–
CCGV	GFCI Receptacle Box Cover – Silver	4-9/16	2-13/16	–	–
CCGV-L	For GFCI receptacle with lock option	4-9/16	2-13/16	–	–
CCSV	For single receptacle	4-9/16	2-13/16	1-1/2	2-3/8
CCSV-L	For single receptacle with lock option	4-9/16	2-13/16	1-1/2	2-3/8

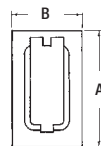

Cat. No.	Description	A (in.)	B (in.)
<b>Single Gang Device Mount Cover – Horizontal and Vertical (zinc)</b>			
DCCU†	Flip-lid cover - for GFCI, single, duplex or switch configuration supplied with 2 adapters and 2 screws, lockable – Silver	4-9/16	2-13/16
DCCU-BR†	Flip-lid cover - for GFCI, single, duplex or switch configuration supplied with 2 adapters and 2 screws, lockable – Bronze		
DCCU-WH†	Flip-lid cover - for GFCI, single, duplex or switch configuration supplied with 2 adapters and 2 screws, lockable – White		

Raintight with cover closed and when used with appropriate Red Dot® boxes. † Lock not included.

## Universal Device Mount Covers

### Single Gang



S340E-R

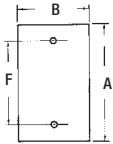

CCMB

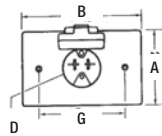

CCPO / CCPO-L

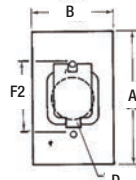

S321E / CCT / CCT-1 / SW1 / SW20-2

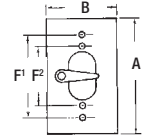

Cat. No.	Description	A (in.)	B (in.)	F (in.)
<b>Single Gang Device Mount Covers</b>				
S340E-R	Blank cover (painted steel) – Silver	4-9/16	2-13/16	3-9/32
S340BRE-R-CN	Blank cover (painted steel) – Bronze	4-9/16	2-13/16	3-9/32
S340WHE-R-CN	Blank cover (painted steel) – White	4-9/16	2-13/16	3-9/32



Cat. No.	Description	A (in.)	B (in.)	D (in.)	F1 (in.)	F2 (in.)	G (in.)
<b>Single Gang Device Mount Covers (zinc)</b>							
CCMB	Motor base cover with 15 A, 125 V plug	2-3/8	4-9/16	1-35/64	–	–	3-9/32
CCPO	Power outlet cover for 30 A and 50 A receptacles box mount	4-9/16	2-13/16	2-5/32	–	2-3/8	–
CCPO-L	Power outlet cover for 30 A and 50 A receptacles box mount with lock option	4-9/16	2-13/16	2-5/32	–	2-3/8	–
S321E	For switch packed with spacers	4-9/16	2-13/16	2-5/32	3-9/32	2-3/8	–
CCT	Switch receptacle cover	4-9/16	2-13/16	2-5/32	3-9/32	2-3/8	–
CCT-1	Switch cover with single pole switch 15 A, 125 V AC	4-9/16	2-13/16	2-5/32	3-9/32	2-3/8	–
CCT-1-20	Switch cover with single pole 20A switch, 120 V, 277 V AC	4-9/16	2-13/16	2-5/32	3-9/32	2-3/8	–
SW1	Switch box cover with lever switch. Single pole. 10 A 125 V	4-9/16	2-13/16	2-5/32	3-9/32	2-3/8	–
SW20-2	Switch cover with double pole 20 A switch, 120 V, 277V AC (all with spacers and screws)	4-9/16	2-13/16	2-5/32	3-9/32	2-3/8	–

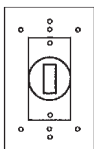

CCK

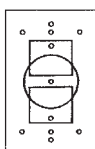

CCSK / S620E-R



Cat. No.	Description
<b>Single Gang Gaskets</b>	
CCK	Neoprene gasket
CCSK	Neoprene gasket
S620E-R	Neoprene gasket

# Universal Device Mount Covers

## Two and Three Gang

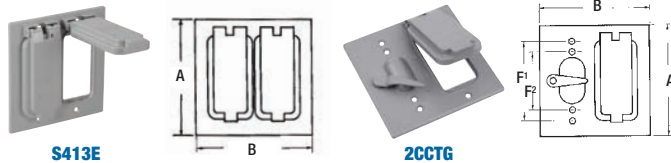

Cat. No.	Description	A (in.)	B (in.)	F1 (in.)	F2 (in.)
<b>Two and Three Gang Device Mount Covers (zinc)</b>					
S413E*	For two GFCI receptacles	4-9/16	4-5/8	-	-
2CCTG*	For switch and GFCI receptacle with spacers	4-9/16	4-5/8	3-9/32	2-3/8

\*Raintight with cover closed and when used with appropriate Red Dot® boxes

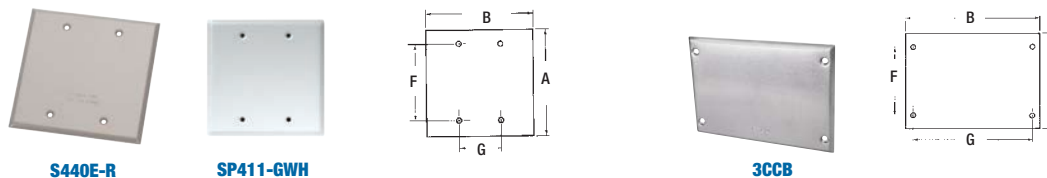

Cat. No.	Description	A (in.)	B (in.)	F (in.)	G (in.)
<b>Two and Three Gang Device Mount Covers (Stamped Aluminum)</b>					
S440E-R	Blank cover, two gang (stamped aluminum) - Grey	4-9/16	4-5/8	3-9/32	1-13/16
SP411-GWH	Blank cover, two gang (stamped aluminum) - White	4-1/2	6-3/8	3-1/4	5-5/8
3CCB	Blank cover, three gang	4-9/16	4-5/8	3-9/32	1-13/16



Cat. No.	Colour	Description	A (in.)	B (in.)
<b>Two Gang Covers (zinc)</b>				
2CCU	Silver	Flip-lid cover for GFCI, duplex or single switch configurations supplied with 4 adapters and 4 screws lockable (lock not included)	4-9/16	4-5/8
2CCU-BR	Bronze	Flip-lid cover for GFCI, duplex or single switch configurations supplied with 4 adapters and 4 screws lockable (lock not included)	4-9/16	4-5/8
2CCU-WH	White	Flip-lid cover for GFCI, duplex or single switch configurations supplied with 4 adapters and 4 screws lockable (lock not included)	4-9/16	4-5/8

## Universal Device Mount Covers

### Two Gang

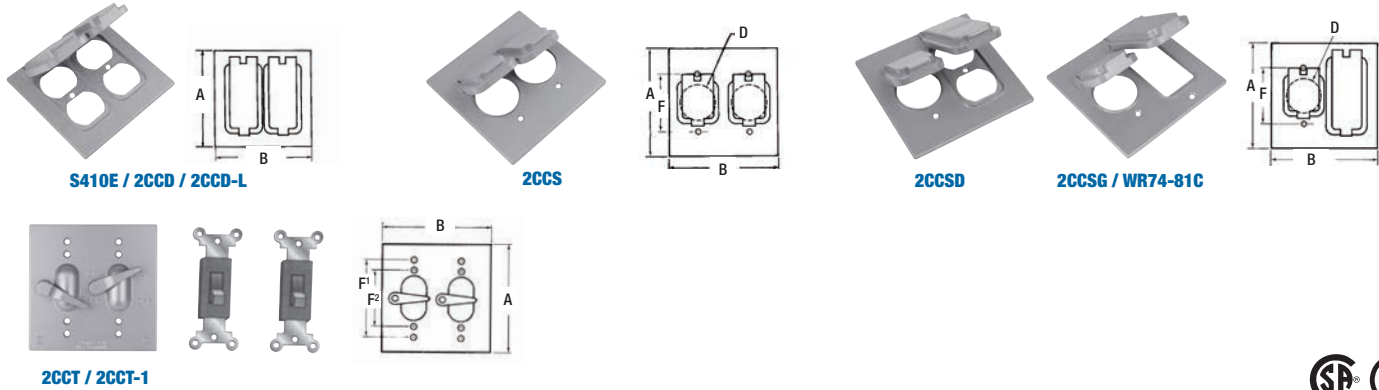

Cat. No.	Description	A (in.)	B (in.)	D (in.)	F (in.)	F1 (in.)	F2 (in.)
<b>Two Gang Device Mount Covers (zinc)</b>							
<b>S410E*</b>	For two duplex receptacles	4-9/16	4-5/8	-	-	-	-
<b>2CCD</b>	2-duplex receptacle box cover	4-9/16	4-5/8	-	-	-	-
<b>2CCD-L*</b>	For two duplex receptacles with lock option (lock not included)	4-9/16	4-5/8	-	-	-	-
<b>2CCS*</b>	For two single receptacles	4-9/16	4-5/8	1-31/64	2-3/8	-	-
<b>2CCSD*</b>	For single and duplex receptacles	4-9/16	4-5/8	1-31/64	2-3/8	-	-
<b>2CCSG*</b>	For single and GFCI receptacles	4-9/16	4-5/8	1-31/64	2-3/8	-	-
<b>WR74-81C</b>	Cover, self-closing lids for single GFCI	4-9/16	4-5/8	-	-	-	-
<b>2CCT</b>	Switch receptacle cover	4-9/16	4-5/8	-	-	2-3/8	3-9/32
<b>2CCT-1*</b>	Switch cover with two single pole switches 15A, 125V AC	4-9/16	4-5/8	-	-	2-3/8	3-9/32
<b>2CCTD</b>	Switch and one duplex receptacle cover	4-9/16	4-5/8	-	-	-	-
<b>2CCTD-1</b>	Switch and one duplex receptacle cover 15 A, 125 V	4-9/16	4-5/8	-	-	-	-
<b>2CCDG</b>	One duplex and one GFCI receptacle	3-11/16	3-3/4	-	-	-	-
<b>2CCG</b>	GFCI receptacle box cover-horizontal	3-11/16	3-3/4	-	-	-	-
<b>WR281-CBR</b>	Bronze cover self-closing lids	4-9/16	4-5/8	-	-	-	-
<b>WR281-C-WH</b>	White cover self-closing lids	4-9/16	4-5/8	-	-	-	-
<b>R104</b>	Two Gang gasket	4-9/16	4-5/8	-	-	-	-

\*Raintight with cover closed and when used with appropriate Red Dot® boxes