

HALO OUTDOOR™

DESCRIPTION

The HALO LED Die Cast floodlight series utilizes selectable CCT functionality, advanced two-stage optics and multiple mounting options for a versatile outdoor lighting solution. Multiple lumen packages and integrated control options address a wide range of outdoor general lighting and security applications. The durable die-cast aluminum housing is available in bronze or white powder coat finish, ensuring years of reliable, maintenance-free operation.

Catalog #		Type
Project		
Comments		Date
Prepared by		

SPECIFICATION FEATURES

Construction

- Durable die-cast aluminum housing with UV stable clear lens
- Powder coated bronze or white finish
- Optically enhanced reflector improves efficiency and delivered lumens
- Tool-less head and motion sensor adjustment
- Wall or eave mounted to recessed or surface junction boxes

Optics

- Two-stage optics for maximum coverage
- Field selectable CCT: 3000K, 4000K and 5000K

Electrical

- 120VAC, 60Hz (Select SKUs)
- 120-277VAC, 60Hz (Select SKUs)
- Maintenance-free LEDs with 70,000 hours of life
- Fixture operating temperature of -30°C to 40°C
- External supply wiring 75°C minimum
- Integral photocell allows for nighttime ON / daytime OFF operation (Integrated sensor SKUs only)

Select Motion SKUs

- Motion sensor detects motion 180° or 270° up to 50 feet
- Selectable duration to keep floodlights on up to 12 minutes
- Adjustable sensitivity
- Integral photocell prevents lights from turning on with motion during daylight hours
- Manual override allows fixture to operate as a standard dusk-to-dawn for up to 6 hours

Warranty

- Five year limited warranty, consult website for details. www.cooperlighting.com

Compliance

- UL certified for US and Canada for wet locations
- EMI/RFI emissions per FCC 47CFR Part 15B
- Contains no mercury or lead and RoHS compliant.
- Photometric testing in accordance with IES LM-79-08
- Lumen maintenance projections in accordance with IES LM-80-08 and TM-21-11



DIE CAST FLOOD SERIES SINGLE, TWIN, TRIPLE FLOODS

seleCCTable™

Suitable for recessed or surface mount electrical junction boxes

DIMENSIONS

FSL303T and FSL203T

Front View

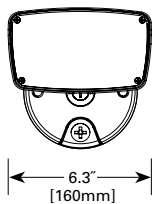

Side View

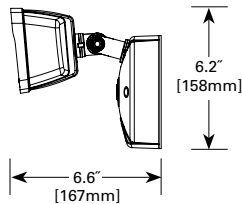

Wall Mount

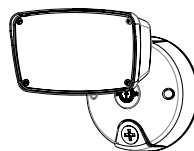

Eave Mount



FSS153T

Front View

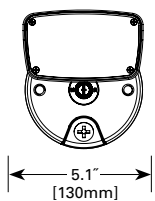

Side View

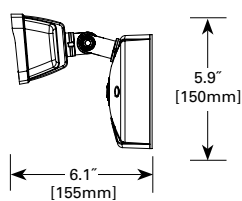

Wall Mount

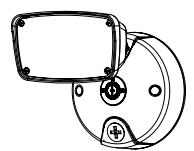

Eave Mount

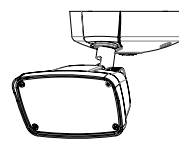

DIMENSIONS

MST203T

Front View

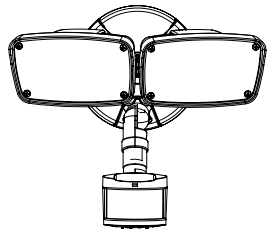
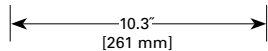

Side View

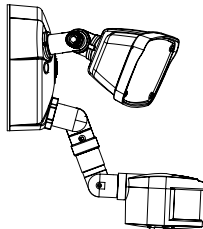
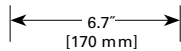

MHS303T

Front View

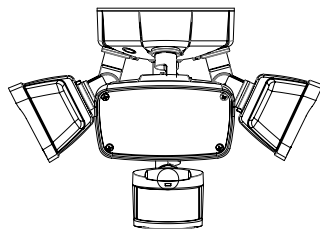
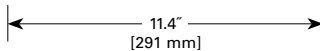

Side View

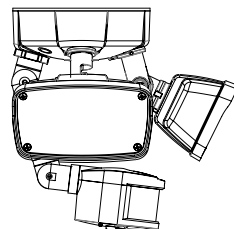
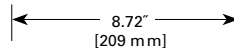

ORDERING INFORMATION

Sample Number: FSS153TIB or MST203T18W

Module	Lumens	CRI/CCT	Options	Colors
FSS = Flood Single Small FSL = Single Large Flood FTS = Flood Twin Small FHS = Flood Triple Small MSS = Motion Small Single MST = Motion Small Twin MSH = Motion Small Triple	15 = 1500 lumens (nominal) 20 = 2000 lumens (nominal) 30 = 3000 lumens (nominal)	3T = Selectable CCT 3000K, 4000K, & 5000K	I = Integrated Photocell 18 = 180° Motion Sensor 27 = 270° Motion Sensor	W = White

PHOTOMETRY

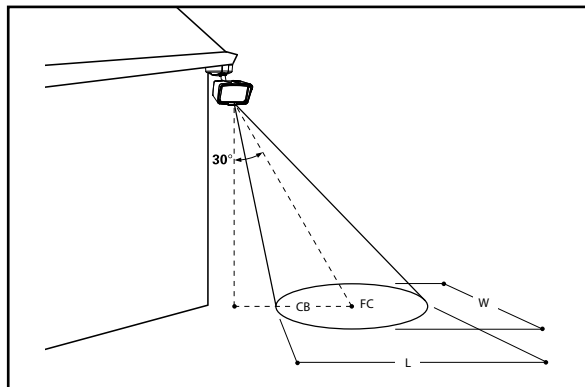

Area Coverage

	Mounting Height	Length (L)	Width (W)	Area (Sq. Ft.)	Max FC
MST203T Series	10 ft.	18	40	720	4.3
	15 ft.	20	40	800	1.9
	20 ft.	20	40	800	1.1

Note: Bronze fixture at a typical mounting angle of 30° from vertical. All figures based on minimum footcandle (FC) of 0.5 and 4000K CCT.

Note: Specifications and Dimensions subject to change without notice.

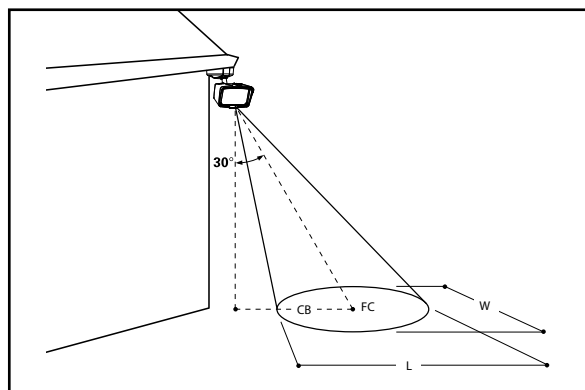

Area Coverage

	Mounting Height	Length (L)	Width (W)	Area (Sq. Ft.)
FSL303T Series	10 ft.	22	38	800
	15 ft.	28	42	1150
	20 ft.	32	50	1500
	25 ft.	35	56	1800
FSL203T Series	10 ft.	20	30	600
	15 ft.	24	40	960
	20 ft.	27	40	1040
FSS153T Series	10 ft.	20	25	400
	15 ft.	20	30	500
	20 ft.	22	35	560

Note: Bronze fixture at a typical mounting angle of 30° from vertical. All figures based on minimum footcandle (FC) of 0.5.

PHOTOMETRY

Series	Voltage	Power (W)	Delivered Lumens (Lm)	Efficacy (Lm/W)	CCT	CRI	Controls
FSS153TB	120-277V	17.3	1503	86.9	3000K,4000K,5000K	84	None
FSS153TW	120-277V	17.3	1503	86.9	3000K,4000K,5000K	84	None
FSS153TIB	120V	17.3	1503	86.9	3000K,4000K,5000K	84	Integrated Photocell
FSS153TIW	120V	17.3	1503	86.9	3000K,4000K,5000K	84	Integrated Photocell
FSL203TB	120-277V	22.5	1916	85.2	3000K,4000K,5000K	84	None
FSL203TW	120-277V	22.5	1916	85.2	3000K,4000K,5000K	84	None
FSL203TIB	120V	22.5	1916	85.2	3000K,4000K,5000K	84	Integrated Photocell
FSL203TIW	120V	22.5	1916	85.2	3000K,4000K,5000K	84	Integrated Photocell
FSL303TB	120-277V	31.6	2900	91.8	3000K,4000K,5000K	84	None
FSL303TW	120-277V	31.6	2900	91.8	3000K,4000K,5000K	84	None
FSL303TIB	120V	31.6	2900	91.8	3000K,4000K,5000K	84	Integrated Photocell
FSL303TIW	120V	31.6	2900	91.8	3000K,4000K,5000K	84	Integrated Photocell
FTS203TB	120-277V	22.8	2034	89.2	3000K,4000K,5000K	84	None
FTS203TW	120-277V	22.8	2034	89.2	3000K,4000K,5000K	84	None
FHS303TB	120-277V	31.8	2853	89.7	3000K,4000K,5000K	84	None
FHS303TW	120-277V	31.8	2853	89.7	3000K,4000K,5000K	84	None
MSH303T18B	120V	31.8	2853	89.7	3000K,4000K,5000K	84	180* Motion Sensor
MSH303T18W	120V	31.8	2853	89.7	3000K,4000K,5000K	84	180* Motion Sensor
MSS153T18B	120V	17.3	1503	86.9	3000K,4000K,5000K	84	180* Motion Sensor
MSS153T18W	120V	17.3	1503	86.9	3000K,4000K,5000K	84	180* Motion Sensor
MST203T18B	120V	22.8	2034	89.2	3000K,4000K,5000K	84	180* Motion Sensor
MST203T18W	120V	22.8	2034	89.2	3000K,4000K,5000K	84	180* Motion Sensor
MST203T27B	120V	22.8	2034	89.2	3000K,4000K,5000K	84	270* Motion Sensor
MST203T27W	120V	22.8	2034	89.2	3000K,4000K,5000K	84	270* Motion Sensor