

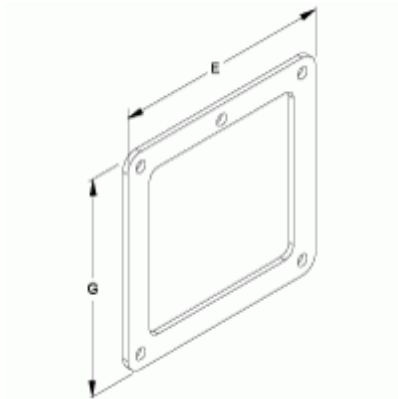

Quality Products. Service Excellence.

Box Connector *1485 K Series*



- Use inside box when entering with "Lay-In" Wireway.

Part No.	For use with	H	W
1485BK	2.5 x 2.5	3.87	3.87
1485CK	4 x 4	5.37	5.37
1485DK	6 x 6	7.62	7.62
1485EK	8 x 8	9.62	9.62
1485FK	12 x 6	13.62	7.62

One angled sealing plate included



Data subject to change without notice

© 2021. Hammond Manufacturing Ltd. All rights reserved.