

## UNIVERSAL COMMERCIAL-CDU

### ALL-IN-ONE LED DOWNLIGHT

4", 6" & 8"

The Universal Commercial downlight series is an all-in-one luminaire that will bring peace of mind to any project. With its high versatility, it enables to choose the right amount of light required as well as the color temperature that will bring out the best out of any space. The Universal Commercial downlight is perfect for both new construction and retrofit solution to replace existing CFL, HID and incandescent luminaires.

#### FEATURES AND SPECIFICATIONS

##### • Construction

###### Finish

- Available in white and alzak finish
- Aluminium
- Frosted polycarbonate lens
- Smooth recessed baffle available in white and alzak finish

###### Mounting

- Spring clips
- Junction box not provided
- Diameter size: 4", 6" and 8"
- Switch on the driver box
- Non IC rated, 9.5 mm spacing required between insulation and fixture
- Retrofit and new construction installations

##### • Technical specifications

- 120-347 V
- Non-dimmable
- 4 power selectable
- Colour temperature selectable  
3 000 K / 3 500 K / 4 000 K
- 90+ CRI
- Estimated lifespan of 54 000 hours to L70
- Ambient temperature:  
- 25 °C / - 4 °F to 40 °C / 104 °F
- Suitable for wet location

##### • Compliances

- Energy Star
- cETLus listed and classified
- cETLus for wet location



#### OVERVIEW

Light source	LED
Diameter (inches)	4, 6, 8
Watts (W)	6 to 35
Lumen output (lm)	500 to 3 000
Efficiency (lm/W)	83 to 90
Color temperature (K)	3 000 / 3 500 / 4 000
CRI	90+
Weight (lbs)	1.82, 2.45, 2.91



quick  
ship



LED  
fixture



power  
selectable



wet  
location



ICES  
005



power  
selectable



**QUICK SHIP AND TECHNICAL SPECIFICATION TABLE**  <sup>1</sup>

Order code	Model number	Watts (W)	Volts (VAC)	Color temp. (K) <sup>2</sup>	Lumen output (lm) <sup>3</sup>	Efficiency (lm/W)	CRI	Life L70 (hrs) <sup>4</sup>	Beam angle (°)	Finish	Power factor	THD (%)	Case qty (master)
<b>4" Round</b>													
67934	CDU4R-PS4Q/3CWH	6 / 9 / 12 / 15	120-347	3 000 / 3 500 / 4 000	500 / 750 / 1 000 / 1 200	83	90+	54 000	75	White	>0.9	<20	8
68420	CDU4R-PS4Q/3CWH AZ	6 / 9 / 12 / 15	120-347	3 000 / 3 500 / 4 000	500 / 750 / 1 000 / 1 200	83	90+	54 000	75	Alzak	>0.9	<20	8
<b>6" Round</b>													
67935	CDU6R-PS4Q/3CWH	10 / 15 / 20 / 25	120-347	3 000 / 3 500 / 4 000	900 / 1 350 / 1 850 / 2 000	90	90+	54 000	85	White	>0.9	<20	8
68421	CDU6R-PS4Q/3CWH AZ	10 / 15 / 20 / 25	120-347	3 000 / 3 500 / 4 000	900 / 1 350 / 1 850 / 2 000	90	90+	54 000	85	Alzak	>0.9	<20	8
<b>8" Round</b>													
67936	CDU8R-PS4Q/3CWH	20 / 25 / 30 / 35	120-347	3 000 / 3 500 / 4 000	1 850 / 2 200 / 2 700 / 3 000	90	90+	54 000	85	White	>0.9	<20	8
68424	CDU8R-PS4Q/3CWH AZ	20 / 25 / 30 / 35	120-347	3 000 / 3 500 / 4 000	1 850 / 2 200 / 2 700 / 3 000	90	90+	54 000	85	Alzak	>0.9	<20	8

<sup>1</sup> **QUICK SHIP:** Product availability is subject to change without notice. Please contact your Stanpro customer service representative to confirm inventory levels at time of order.

<sup>2</sup> Typical color temperature range: +/- 5 %.

<sup>3</sup> Lumen values are derived from photometric testing. Initial lumens range: +/- 10 %.

<sup>4</sup> Life hours are derived from IESNA LM-80-08 testing report and projected per IESNA TM-21-11 extrapolations.

**ACCESSORIES (order separately)<sup>1</sup>**

Order code	Description	Inner diameter (in)	Outer diameter (in)	Case qty (master)
68611 <sup>2</sup>	MPLATE HANG.BARS-4.75IN	4 3/4	N/A	12
66817 <sup>2</sup>	ACC/MPLATE/VELOCE6/HANG.BARS/STD	6	N/A	8
66818 <sup>2</sup>	ACC/MPLATE/VELOCE8/HANG.BARS/STD	8	N/A	8
68614	GOOF RING-4.75IN	4 7/8	7 1/2	24
68615	GOOF RING-6.75IN	6 3/4	9 1/4	24
68616	GOOF RING-8IN	8 1/4	11 1/2	24

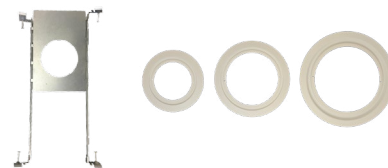

<sup>1</sup> For more information, please consult individual specification sheet.

<sup>2</sup> Junction box not included

**CEILING OPENING / HOUSING COMPATIBILITY**

Model	Cutting hole diameter in. (mm)
67934 - CDU4R	4 3/4 (120.50)
67935 - CDU6R	6 3/8 (161.20)
67936 - CDU8R	7 7/8 (199.60)

**DIMENSIONS**

4"

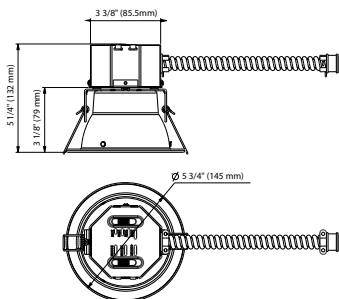

6"

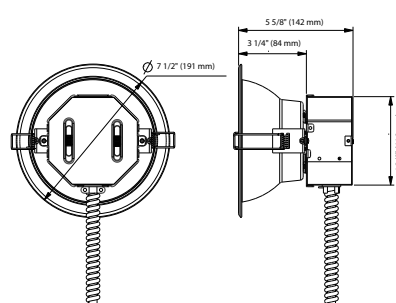

8"

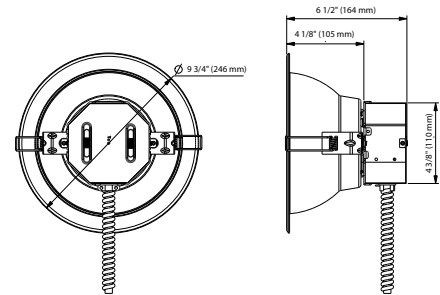

Data is based upon tests performed in a controlled environment. Actual performance can vary depending on operating conditions. All products are subject to change or may be discontinued any time without notice.

**PHOTOMETRIC DATA<sup>1</sup>**

67934 • CDU4R-PS4Q/3CWH (15 W, 3 000 K) • 1 219.3 lm

**Polar candela distribution**

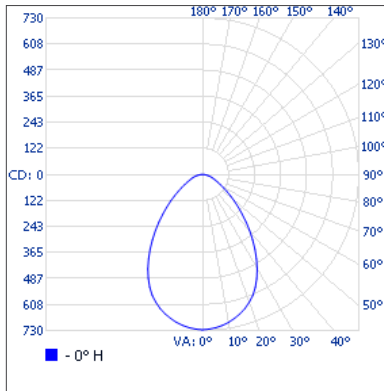

**Zonal lumen summary**

Zone	Lumens	% Fixture
0-30	523.6	42.4%
0-40	789.1	63.9%
0-60	1 117.8	90.5%
60-90	117.2	9.5%
0-90	1 235.0	100%

**Illuminance at a distance**

Center beam fc	Beam width
1.7'	2.7'
3.3'	5.3'
5.0'	8.0'
6.7'	10.7'
8.3'	13.3'
10.0'	16.0'

Vert. spread: 77.5°

67935 • CDU6R-PS4Q/3CWH (25 W, 3 000 K) • 2 321.6 lm

**Polar candela distribution**

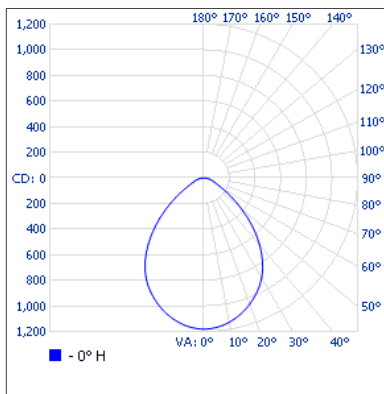

**Zonal lumen summary**

Zone	Lumens	% Fixture
0-30	872.6	39.4%
0-40	1 368.8	61.8%
0-60	2 024.8	91.4%
60-90	190.2	8.6%
0-90	2 214.9	100%

**Illuminance at a distance**

Center beam fc	Beam width
1.7'	3.2'
3.3'	6.2'
5.0'	9.3'
6.7'	12.5'
8.3'	15.5'
10.0'	18.7'

Vert. spread: 86.1°

67936 • CDU8R-PS4Q/3CWH (35 W, 3 000 K) • 3 188.5 lm

**Polar candela distribution**

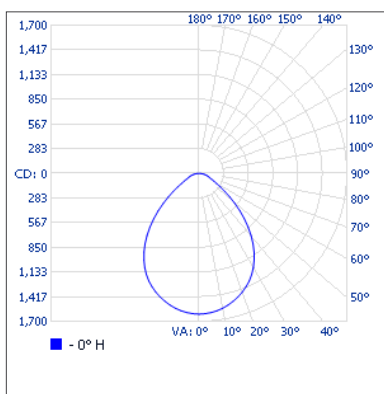

**Zonal lumen summary**

Zone	Lumens	% Fixture
0-30	1 209.2	37.9%
0-40	1 900.1	59.6%
0-60	2 806.2	88%
60-90	290.3	9.1%
0-90	134.1	4.2%

**Illuminance at a distance**

Center beam fc	Beam width
1.7'	3.2'
3.3'	6.2'
5.0'	9.4'
6.7'	12.6'
8.3'	15.6'
10.0'	18.8'

Vert. spread: 86.4°

<sup>1</sup> Complete IES files available on our website.

Data is based upon tests performed in a controlled environment. Actual performance can vary depending on operating conditions. All products are subject to change or may be discontinued any time without notice.