

# STATIC & AIR-HANDLING FIXTURES

Door Frames, Lenses and Louvers

Listed below are the door frames and shielding media available for Lithonia Lighting static and air-handling fixtures. The matrix shows the availability for each option within specific fixture families.

Other lenses and louvers are available. Contact your Lithonia Lighting sales representative.



DOOR FRAMES & DIFFUSERS FOR STATIC & AIR-HANDLING TROFFERS							
	NOMENCLATURE	DESCRIPTION	GT8	SP8/SP5	SP	SP AIR	TLED
DOOR FRAMES <sup>1</sup>	RN	Regressed natural anodized aluminum	■	■	■	■	
	RW	Regressed aluminum, white finish	■	■	■	■	■
	RM	Regressed aluminum, matte black finish	■	■	■	■	
	FN	Flush natural anodized aluminum	■	■	■	■	
	FW	Flush aluminum, white finish	■	■	■	■	■
	FM	Flush aluminum, matte black finish	■	■	■	■	
LENSES AND LOUVERS	A12	#12 pattern acrylic	■	■	■	■	■
	A12125	#12 pattern acrylic, .125" thick	■	■	■	■	■
	RA125	#12 pattern acrylic, reverse apex, .125" thick <sup>2</sup>		■			
	A19	#19 pattern acrylic, .156" thick	■	■	■	■	■
	ASL	Low-brightness acrylic school lens	■	■	■	■	□
	ARF12	Radio frequency shielding (A12; others available)	■	■	■	□	
	AC	Dropped dish, matte white acrylic	■	■	■		
	PC1	Parabolic plastic-cube, 1/2"x1/2"x1/2" <sup>3</sup>	■	■	■	□	
PC2	Parabolic plastic-cube, 1-1/2"x1-1/2"x1" <sup>3</sup>	■	■	■	□		
PC3	Parabolic plastic-cube, 3/4"x3/4"x1/2" <sup>3</sup>	■	■	■	□		
REFLECTIVE SURFACES	SSR	95% reflective silver	■	■	■	■	

■ = Available on all models.

□ = Available on most models; consult factory for exceptions.

#### Notes

- 1 Flush steel door standard unless otherwise noted. To order door frames, add designation after lamps in catalog number.
- 2 Pattern acrylic, reverse apex, .125" thick.
- 3 Add suffix S for silver or G for gold. Example: PC1G. For acrylic, add A. Example: PC1SA.

## Door Frame Finishes

### Regressed Aluminum

RN – Natural anodized  
RM – Matte black  
RW – White



### Flush Aluminum

FN – Natural anodized  
FM – Matte black  
FW – White



### Flush Steel

White (standard)



## Ceiling Compatibility

TYPE OF CEILING	PARAMAX® AND OPTIMAX®		
	APPROPRIATE TRIM TYPE		
	G	F	ST
Exposed grid tee	■		
Concealed grid tee	■		■
Concealed Z spline		■	
Screw slot <sup>1</sup>			■
Plaster or plasterboard		■	

■ = Available

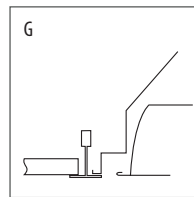

Lay-in trim, exposed grid tee

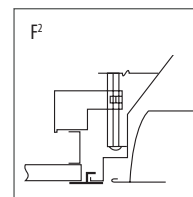

Overlapping flanged trim with swing-gate hangers

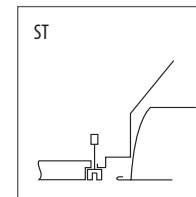

Screw slot trim, lower flush to ceiling

TYPE OF CEILING	SP, SP8, GT8	
	APPROPRIATE TRIM TYPE	
	G	F
Exposed grid tee	■	
Concealed grid tee	■	
Concealed Z spline		■
Metal pan <sup>1</sup>		■
Screw slot <sup>1</sup>	■	
Plaster or plasterboard		■

■ = Available

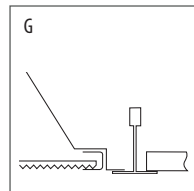

Lay-in trim, exposed or concealed grid tee

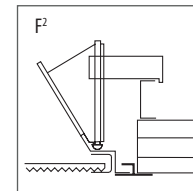

Overlapping flanged trim with swing-gate hangers

## Plaster Frames (order separately)

Plaster frames provide a clean, square edge for plaster ceiling openings. Order F trim factory installed on fixture, then order appropriate size plaster frame option for each fixture to be installed. (Not required for drywall ceilings.)

PF4	Pair of sides for 4' long
PF2	Pair of sides for 2' long
PFE	Pair of ends for 1'x4'
2PFE	Pair of ends for 2' wide
20PFE	Pair of ends for 20" wide

## Filler Pans (order separately)

Accessory filler pans to finish out ceiling grids. Side filler pans typically are used when 20"-wide fixtures are installed in 2'-wide grid systems. End filler pans are used to install 4' units into 5' grid systems.

2FP2	Side filler pans (pair), white, 2" wide, 2' long.
2FP6	End filler pans (pair), white, 6" wide, 2' long.
4FP2	Side filler pans (pair), white, 2" wide, 4' long.
20FP6	Side filler pans (pair), white, 6" wide, 20" long.

## Drywall Grid Adapter

Drywall grid adapters (DGA) are used to install grid trimmed troffers in plasterboard or other hard ceilings. Order DGA accessories separately. Compatible with all lay-in troffers. Order using DGA plus nominal fixture size. Example: DGA24.

### Notes

- Consult factory prior to order.
- Requires CRE and CRM trim options for continuous row mounting. Metric versions of some recessed fluorescent fixtures are available. Consult [www.lithonia.com](http://www.lithonia.com) for details.

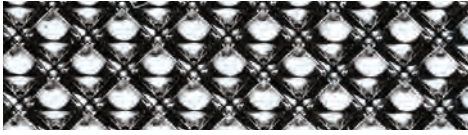
Lens Options<sup>1</sup>A12<sup>2</sup>

- Standard Lithonia Lighting shielding
- Extruded, clear 100% acrylic
- 3/16" female prisms
- Nominal .095" thick (.125", .156" and .187" optional)<sup>3,4</sup>

Example: 2GT8 4 32 A12 MVOLT 1/4 GEB10IS

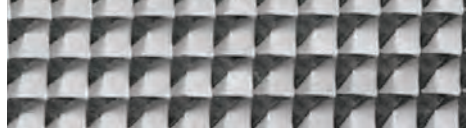

## A19

- High VCP — very low brightness in direct glare zone
- 3/16" square-base male conical prisms
- High efficiency
- Minimizes lamp image
- Nominal .156" thick (.187" optional)<sup>4</sup>

Example: 2SP8 G 3 32 A19 MVOLT 1/3 GEB10IS



## ASL

- Acrylic school lens, developed for lighting applications where brightness control is critical (schools, libraries, etc.)
- Extruded, clear 100% acrylic
- Nominal .156" thick (.187" optional)<sup>4</sup>

Example: 2SP8 G 3 32 ASL MVOLT 1/3 GEB10IS



## PC1

- Injection-molded parabolic polystyrene plastic louver
- 1/2"x1/2"x1/2" square cell, 45° shielding
- Specify choice of specular gold (G) or specular silver (S)

Example: 2SP8 G 3 32 PC1S MVOLT 1/3 GEB10IS



## PC2

- Injection-molded parabolic polystyrene plastic louver
- 1-1/2"x1-1/2"x1" square cell, 35° shielding
- Specify choice of specular gold (G) or specular silver (S)

Example: 2SP8 G 3 32 PC2S MVOLT 1/3 GEB10IS



## PC3

- Injection-molded parabolic polystyrene plastic louver
- 3/4"x3/4"x1/2" square cell
- Specify choice of specular gold (G) or specular silver (S)

Example: 2SP8 G 3 32 PC3S MVOLT 1/3 GEB10IS

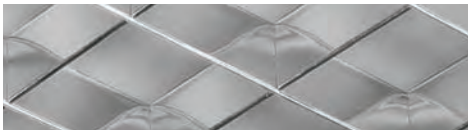

## Small-Cell

- Small-cell aluminum parabolic louvers for SP AIR
- Choice of cell size and 1-1/2" or 3/4" depth
- Specify number of cells plus louver depth (15 for 1.5" and 75 for .75") and finish. For 78 cells, 1.5" deep, specular finish:

Example: 2SP G B 3 32 7815LS MVOLT 1/3 GEB10IS.

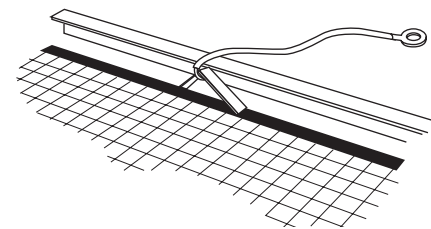

## RF – Radio Frequency Shielding

- For hospitals, TV stations or where sensitive electronic equipment is in use
- Choice of patterns and thicknesses<sup>4</sup>
- Not available in fixtures with lens gasketing

## Reflective Surface

- SSR 95% minimum-reflectance silver inserts. 10-year warranty by material manufacturer.

## Notes

- 1 Additional lenses and louvers available. Consult [www.lithonia.com](http://www.lithonia.com) for details.
- 2 Reverse apex prism design used on SP8 only.
- 3 For .125", specify RA125.
- 4 To order any lens with optional thickness, add thickness to designation.  
Example: 2SP8 G 3 32 A12125 MVOLT GEB10IS

Listed below are major electrical wiring and other options available for Lithonia Lighting static and air-handling fixtures. The matrix shows the availability of each option within specific fixture families.

Certain combinations of options are incompatible in the same fixture. Consult factory for details.

# STATIC & AIR-HANDLING FIXTURES

Electrical, Wiring & Misc. Options



ELECTRICAL, WIRING & MISCELLANEOUS OPTIONS FOR STATIC & AIR-HANDLING TROFFERS														
To order, add designation as a suffix to fixture catalog number, unless otherwise noted.														
	NOMENCLATURE	DESCRIPTION	GT8	SP8/SP5	SP	SP AIR	PM2/PM4	PMO/PM3/HPM3	2PM3N	NAT/CNAT	AV	WW	RTS/RT8	ES8
ELECTRICAL	-	Ballast options	■	■	■	■	■	■	■	■	■	■	■	■
	-	Dimming ballast	■	■	■	■	■	■	■	■	■	■	■	■
	MVOLT	Multi-volt ballasts (120-277V) <sup>1</sup>	■	■	■	■	■	■	■	■	■	□	■	■
	EL/EL14	Emergency lighting <sup>2</sup>	■	■	■	■	■	■	■	■	■	□	■	■
	GLR/GMF	Fusing	■	■	■	■	■	■	■	■	■	■	■	■
	RIF	Radio interference filter	■	■	■	■	■	■	■	■	■	■	■	■
	FR	Labeled for fire-rated ceiling	■	■	■	■	■	■	■	■	■	■	■	■
WIRING	PW_	Prewiring	■	■	■	■	■	■	■	■	■	■	■	■
	LST	Labor-saving tandem	■	■	■	■	■	■	■	■	■	□	□	■
	-	RELOC <sup>®</sup> wiring systems	■	■	■	■	■	■	■	■	■	■	■	■
MISCELLANEOUS	2R	Two channel covers installed					■		■					
	LG	Additional lens gasketing <sup>3</sup>	■	■	■	■								
	HTC	T-bar safety clips (snap-on) <sup>4</sup>	■	■	■	■	■	■	■		■			
	LATC	T-bar safety clips (screw-on) <sup>4</sup>	■	■	■	■	■	■	■	■	■	■	■	■
	APB	Air-pattern control blades				■	■	■	■					
	HRD	Heat-removal dampers				■	■	■	■					
	ACS	Air closure strips				■	■	■	■					
	-	Lamps furnished and installed	■	■	■	■	■	■	■		■	■	■	■
JP	Job pack <sup>5</sup>	■	■	■	■	■	■	■		■	□	■	■	

■ = Available on all models.  
 □ = Available on most models; consult factory for exceptions.

**Notes**

- 1 Consult factory for availability.
- 2 Addition of emergency battery pack options may increase overall fixture depth. Consult factory.
- 3 Aluminum doors only.
- 4 Integral T-bar safety clips are standard for most models of GT8, SP8, ES8, RTS, AV, SP, 2PM2, 2PM4, 2PM3N and 2PMO fixture families. Also available on 1x4 PM3, PMO and HPM3 fixtures. Consult factory for specific exceptions.
- 5 Palletized and stretch-wrapped without individual cartons. Available for G (grid) and MT (modular) trims only.

PRODUCT INFORMATION

# LABOR-SAVING TANDEM OPTIONS

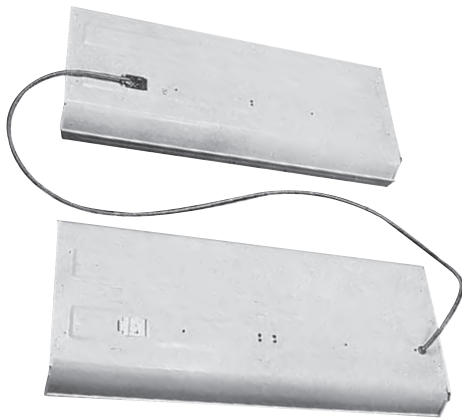

Reduces the number of ballasts required for fluorescent fixtures.

Simple, snap-together design.

Uses half the connections, and uses half the wiring and components.

Available on most sizes and types of Lithonia Lighting fixtures with access plates. Wiring connections for both fixtures located at one access plate.

Interconnection cable is fully prewired and pre-assembled.

Polarized nylon plugs ensure positive connections and prevents miswiring.

Identified ballast leads simplify multi-level switching.

Simply wire in the master unit using hard wiring, prewiring or RELOC® wiring. Then snap-connect the satellite unit to the master unit. Installation is complete.

ORDERING INFORMATION

**Example:** 2SP8 G 3 32 A12 MVOLT GEB10IS LST11

1. Select desired troffer model.
2. Add one of the following as a suffix to standard Lithonia Lighting catalog number:
  - LST 9' cable (standard cable length)
  - LST7 7' cable
  - LST11 11' cable
3. Consult factory for other lengths.
4. Not available for use with dimming ballast.
5. Order fixtures in pairs. Factory will supply correct number of master and satellite units.
6. Not available with energy-saving T8 lamps.

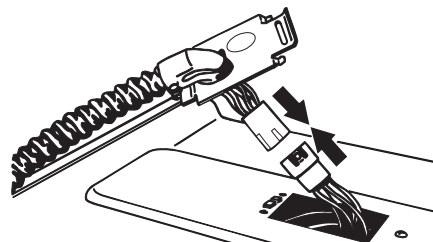

Join nylon connector

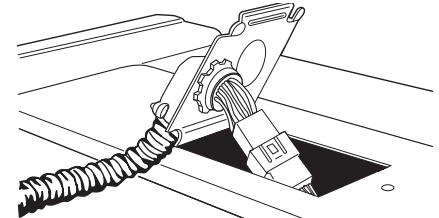

Close access plate

## LST Method (saves up to 40% of installation labor and wiring costs)

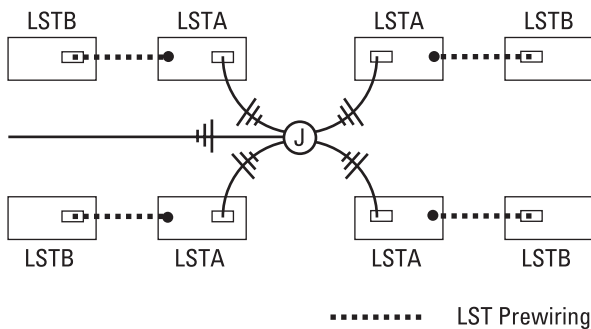

## Conventional Method

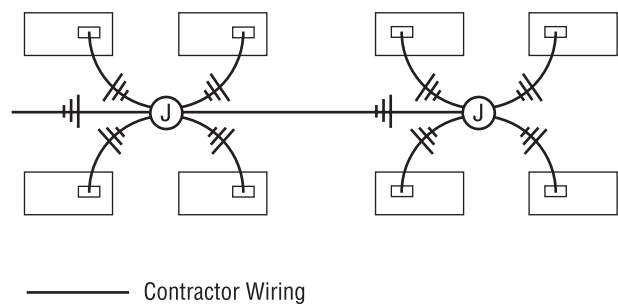

Lithonia Lighting manufactures a complete line of fixtures designed to provide any level of air-handling capability, from simple heat removal to a combination of all air functions. Compatible with a full range of air equipment by major manufacturers, these fixtures comprise the most complete and comprehensive family of air-handling fixtures available.

Ductwork, including air boots, supplied by others.

Best choice for...

- Dependable performance
- Application flexibility
- Air-equipment compatibility

# AIR-HANDLING OPTIONS

## Complete Air-Handling Capability (available on SP AIR, Paramax® and Optimax® fixtures)

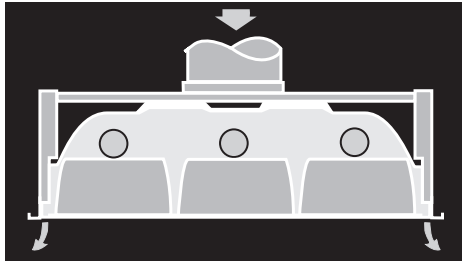

### A – Air Supply

Air is supplied to occupied space through slots in side rails. Air diffusers connected to slots provide cooled or heated air to the space. Optional air-pattern control blades control airflow.

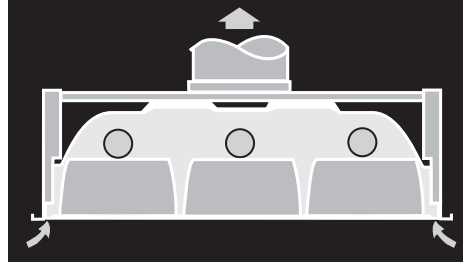

### A – Air Return

Air is removed from occupied space through slots in side rails. Air is returned to plenum or to air diffusers connected to slots.

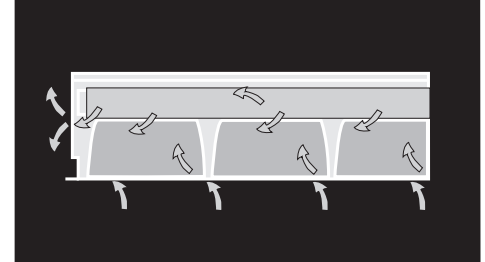

### H – Heat Removal

Room air and fixture heat are removed through slots in the top or end of fixture housing. Slots in top are louvered to minimize entry of plenum contaminants into lamp cavity. Optional dampers available to control air flow.

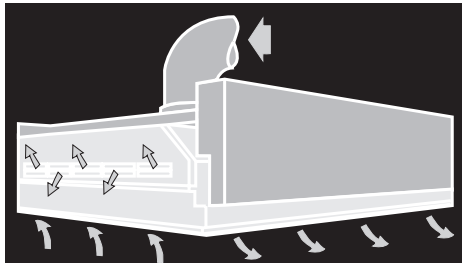

### D – All Air Functions

Full-function air-handling capability. Dual-function air supply and/or return through side rails and heat removal through lamp cavity.

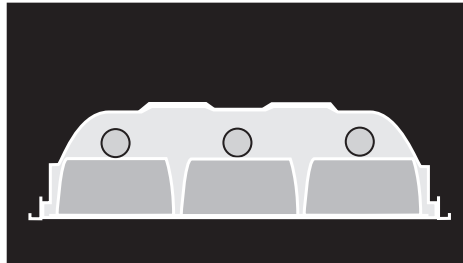

### B – No Air Functions

Static troffer that provides no air functions, but matches other models in appearance for continuity of design.

## Air Control Options

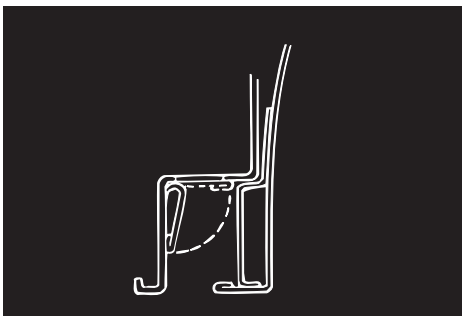

### APB – Air-Pattern Control Blades

Designed to adjust or direct airflow on air supply/return models. Adjusts without tools from fully open to fully closed. Accessible from below.

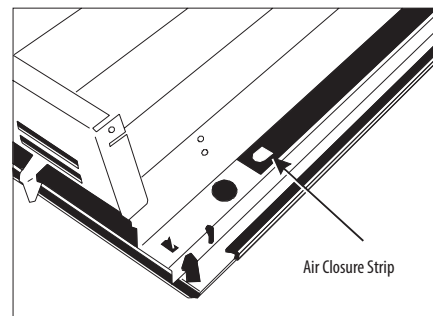

### ACS – Air Closure Strips

Designed to convert fixture from air-handling to static in the field (no tools required). Not accessible from below.



# MISCELLANEOUS

## Lamps Furnished and Installed

(Troffers only)

LP730	70+ CRI, 3000K
LP735	70+ CRI, 3500K
LP741	70+ CRI, 4100K
LP830	80+ CRI, 3000K
LP835	80+ CRI, 3500K
LP841	80+ CRI, 4100K
L830HT8	85 CRI, 3000K, long life, 3100 lumens
L835HT8	85 CRI, 3500K, long life, 3100 lumens
L841HT8	85 CRI, 4100K, long life, 3100 lumens
LPM830P	80+ CRI, 3000K, premier lamp
LPM835P	80+ CRI, 3500K, premier lamp
LPM841P	80+ CRI, 4100K, premier lamp
L830XP	80+ CRI, 3000K, premier XP
L835XP	80+ CRI, 3500K, premier XP
L841XP	80+ CRI, 4100K, premier XP

Example: 2SP8 G 3 32 A12 MVOLT GEB10IS LP735

## PW – Prewiring Option

(Troffers only)

Complete range of prewired whips for every installation requirement.

- Factory-installed flexible cable, wired into fixture through access plate.
- 3/8" cable with snap-in connectors standard. 1/2" cable optional.
- Choice of wire gauge.
- Up to five wires, including one neutral (white) and one ground (green) – permits multi-level switching.
- Ready to connect to J-box.



PW1236	6' prewire, 1/2" dia., 12-gauge, 1 circuit
PW1246	6' prewire, 1/2" dia., 12-gauge, 2 circuit
PW1256	6' prewire, 1/2" dia., 12-gauge, 3 circuit
PW1836	6' prewire, 1/2" dia., 18-gauge, 1 circuit
PW1846	6' prewire, 1/2" dia., 18-gauge, 2 circuit
PW1856	6' prewire, 1/2" dia., 18-gauge, 3 circuit
PWS1236	6' prewire, 3/8" dia., 12-gauge, 1 circuit
PWS1246	6' prewire, 3/8" dia., 12-gauge, 2 circuit
PWS1256	6' prewire, 3/8" dia., 12-gauge, 3 circuit
PWS1836	6' prewire, 3/8" dia., 18-gauge, 1 circuit
PWS1846	6' prewire, 3/8" dia., 18-gauge, 2 circuit
PWS1856	6' prewire, 3/8" dia., 18-gauge, 3 circuit

Example: 2GT8 3 32 A12 MVOLT 1/3 GEB10IS PWS1836

## Insulation

- IC Insulation contact (recessed)  
Consult factory.

## Radio Interference Filters

- RIF Inductive capacitor circuit designed to minimize interference from feedback into line. 120V or 277V, 50Hz or 60Hz. Order either one per fixture (RIF1) or one per ballast (RIF2).  
Example: 2SP8 G 3 32 A12 277 GEB10IS RIF1
- EIS Inductive capacitor circuit designed to minimize interference from feedback into line. Meets MIL-STD 461A/462/463. Order either one per fixture (EIS1) or one per ballast (EIS2).  
Example: 2SP8 G 3 32 A12 120 GEB10IS EIS2

## Construction for Fire-Rated Ceilings

(Troffers only)

- FR Lithonia fluorescent troffers are UL Listed and are compatible with UL fire-rated ceiling assemblies. Upon request for the FR option, the FR label is applied to the back of the housing. Label states: This troffer is specially designed to be installed in fire-rated or insulated ceilings.

Example: 2GT8 4 32 A12 MVOLT 1/4 GEB10IS FR

NOTE: Not applicable for CSA or NOM listings. Some dimming and some compact lamp troffers may require electronic ballasts.

## T-Bar Safety Clips

(Troffers only)

- LATC Hold-down clips to secure troffer to T-bar. Field installed. Attach by screwing to fixture end plates. Four furnished per fixture.  
Example: 2PM4 G B 3 32 18LD MVOLT 1/3 GEB10IS LATC

Note: Safety clips may be used on fixtures with integral T-bar clips if additional means of attachment are required.

Snap-on Clips. (Troffers, RR, CRR)

- HTC Hold-down clips to secure troffer to T-bar. Four furnished per fixture.

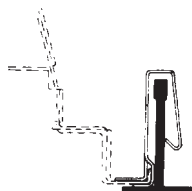

## Fusing

One per ballast furnished. Fusing not recommended for use with 277V magnetic dimming ballasts.

Internal Fusing

- BKTK Internal fast-blow fuse. For use in 347V fixtures.  
GLR Internal fast-blow fuse.  
GMF Internal slow-blow fuse

External Fusing

(Strips and open industrials only)

- GLRX External fast-blow fuse.  
GMFX External slow-blow fuse.

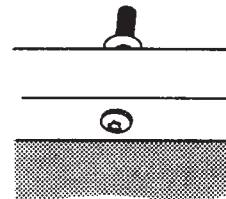

## Spring Latches

(Troffers and M Series only)

- SLL Spring-loaded latch option (standard on 2SP) others consult factory  
SAL Spring-action latch option (Aluminum doors only)  
Example: 2GT8 4 32 FW A12 MVOLT GEB10IS SAL

## Tandem Quick-Connect Plug-In

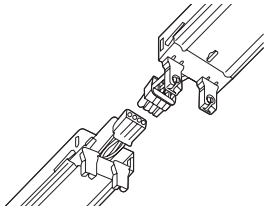

Fully prewired secondary wiring for continuous row, strip and industrial applications. Simply install two channel sections and connect plugs.

One worker can install – more efficient than a two-worker installation of one 16-foot length. Lock-together nylon plugs are polarized to prevent miswiring.

Available on all tandem-wired (T) strip, industrial fixtures and a variety of architectural row-mounted products.

TWP and TILWP available. Consult factory.

## Ballast Options

- GEB10IS Electronic ballast, instant start, ≤ 10% THD, MVOLT (120-277V) standard. Factory choice, T8 and CF40.
- GEB10PS Electronic ballast, program start, ≤ 10% THD, MVOLT (120-277V) standard. Factory choice, T8, T5 and T5HO.
- GEB10RS Electronic ballast, rapid start, ≤ 10% THD, MVOLT (120-277V) standard. Factory choice, CF40 and TTS.
- BINP High-efficiency T8 electronic ballast, instant start, ≤ 10% THD, MVOLT (120-277V) standard. Factory choice.
- BPNP High-efficiency T8 electronic ballast, program start, ≤ 10% THD, MVOLT (120-277V) standard. Factory choice.
- BSNP High-efficiency T8 electronic ballast, step dimming (100-50%) program start, ≤ 10% THD, MVOLT (120-277V) standard. Factory choice.
- GEB95 High-efficiency T5 electronic ballast, program start, ≤ 10% THD, MVOLT (120-277V) standard, 0.95 ballast factor. Factory choice for T5 and T5HO. Also available in 0.80, 0.90 and 1.15 ballast factors. Available in select fixture models.
- GEB95S High-efficiency T5 electronic ballast, step dimming (100-50%), program start, ≤ 10% THD, MVOLT (120-277V) standard, 0.95 ballast factor. Factory choice for T5 and T5HO. Also available in 0.80, 0.90 and 1.15 ballast factors. Available in select fixture models.
- Dimming Several options available including low voltage, line voltage and addressable dimming systems.

Generic nomenclature above represents normal (0.87 or 0.88) ballast factor, except when noted otherwise. Other choices available. Ballast manufacturer may be specified. Consult factory for nomenclature. Additional ballast information available on [www.lithonia.com](http://www.lithonia.com).

## Emergency Battery Packs

Factory-installed Lithonia Emergency Systems battery pack available for most fluorescent fixtures. See page 474 for lamp and ballast compatibility. Addition of an emergency option may increase fixture depth in some 2'x2' troffers. Consult factory.

## Emergency Battery Packs (cont.)

UL Listed	CSA Certified	
EL	B100C	Fixture equipped for one-lamp emergency operation of 4' lamps. (PS300QD installed)
EL5	B90C	Fixture equipped for one-lamp emergency operation of 4' lamps. (PS500QD installed)
EL6	B70C	Fixture equipped for one-lamp or two-lamp emergency operation of 4' lamps and one-lamp emergency operation of 8' lamps. (PS600QD installed)
EL14	B50C	Fixture equipped for one-lamp or two-lamp emergency operation of 4' lamps and one-lamp operation of 8' lamps. (PS1400QD installed)
EM	CEM	Inverter only option. Fixture labeled for emergency use, no integral ballast.

Add suffix DW to catalog number to specify damp/wet listing. UL Listed only. Example: EL6DW

## Packaging

Job-site load of fixtures on pallets, wrapped without individual cartons. Secured to pallet.

- No carton disposal.
- Faster and easier to unpack.
- Paramax® and other Lithonia Lighting troffers packed with end protectors secured to pallet by heavy-duty plastic.
- Industrials and strips protected by heavy-duty corrugated sheet and secured to pallet. Reflectors packed separately.

JP Job Pack  
Consult factory for availability.

Add suffix JP to fixture catalog number. Factory will determine number of fixtures per pallet.

Example: 2GT8 4 32 A12 MVOLT GEB10IS JP



# MISCELLANEOUS

## Ceiling Spacer (order separately)

- 1B Hanger spaces fixtures 1-1/2" to 2-1/2" from ceiling. For unit mounting, order two per fixture; for row mounting, order one per fixture plus one per row. Standard pack: 2, 20, 100.



## Swivel-Stem Hangers (order separately)

- SQ\_ Complete assembly with stem up to 72" (consult factory for longer lengths). Specify stem length in 2" increments and adjust as needed. 5/8" O.D. stem. Swivels 30° from vertical in any direction. Example: SQ24
- HDSQ\_ Complete heavy-duty assembly. Specify length in 2" increments and adjust as needed, swivels 45° from vertical. Example: HDSQ36
- ST\_ Pipe stem only. Specify length up to 72". Example: ST18
- Q Canopy, offset bar and parts only.
- ST\_TBE Pipe stem only, threaded both ends. Coupler included. Specify length from 6" to 72". Example: ST48TBE.

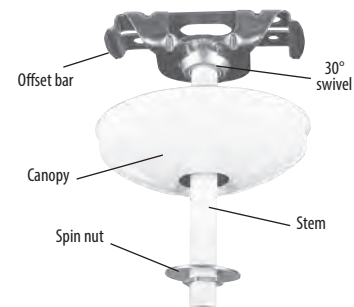

## Double-Stem Hangers (order separately)

- DSH24 Complete assembly with double canopy and two 24" stems on 10" centers. For most 4' fixtures. Other stem lengths available.





# SURFACE MOUNT

Electrical, Hanging & Misc. Options

Listed below are the major electrical and other options available for Lithonia Lighting fluorescent fixtures. The matrix shows the availability of each option within specific fixture families.

Additional options and accessories are available. Contact your Lithonia Lighting sales representative for more information.



## ELECTRICAL, HANGING & MISCELLANEOUS OPTIONS FOR COMMERCIAL FIXTURES

Order hanging devices as accessories, using separate catalog numbers. Order options by adding suffix to catalog number, unless otherwise noted.

NOMENCLATURE		PMOX/PM3X	M	AW	CA	SB	LB/CB	CLM	ST	RTX
ELECTRICAL	--	Ballast options	<input type="checkbox"/>	<input type="checkbox"/>	<input type="checkbox"/>	<input type="checkbox"/>	<input type="checkbox"/>	<input type="checkbox"/>	<input type="checkbox"/>	<input checked="" type="checkbox"/>
	--	Dimming ballast	<input type="checkbox"/>	<input type="checkbox"/>	<input type="checkbox"/>	<input type="checkbox"/>	<input checked="" type="checkbox"/>	<input type="checkbox"/>	<input type="checkbox"/>	<input checked="" type="checkbox"/>
	EL/EL14/EL55/EL65	Emergency lighting	<input type="checkbox"/>	<input type="checkbox"/>	<input checked="" type="checkbox"/>	<input checked="" type="checkbox"/>	<input type="checkbox"/>	<input type="checkbox"/>	<input checked="" type="checkbox"/>	<input checked="" type="checkbox"/>
	GLR/GMF	Fusing	<input checked="" type="checkbox"/>	<input checked="" type="checkbox"/>	<input checked="" type="checkbox"/>	<input checked="" type="checkbox"/>	<input checked="" type="checkbox"/>	<input checked="" type="checkbox"/>	<input checked="" type="checkbox"/>	<input checked="" type="checkbox"/>
	RIF	Radio interference filter	<input checked="" type="checkbox"/>	<input checked="" type="checkbox"/>	<input checked="" type="checkbox"/>	<input type="checkbox"/>	<input checked="" type="checkbox"/>	<input type="checkbox"/>	<input checked="" type="checkbox"/>	<input checked="" type="checkbox"/>
HANGING DEVICES	SQ_	Swivel-stem hanger	<input type="checkbox"/>	<input checked="" type="checkbox"/>	<input type="checkbox"/>	<input checked="" type="checkbox"/>	<input type="checkbox"/>	<input checked="" type="checkbox"/>	<input checked="" type="checkbox"/>	<input type="checkbox"/>
	DSH24	Double-stem hanger			<input type="checkbox"/>		<input type="checkbox"/>	<input type="checkbox"/>	<input checked="" type="checkbox"/>	
	1B	Ceiling spacer	<input type="checkbox"/>	<input checked="" type="checkbox"/>	<input type="checkbox"/>	<input checked="" type="checkbox"/>	<input type="checkbox"/>	<input checked="" type="checkbox"/>	<input checked="" type="checkbox"/>	
MISCELLANEOUS	SSR	95% reflective silver	<input type="checkbox"/>	<input type="checkbox"/>			<input checked="" type="checkbox"/>	<input checked="" type="checkbox"/>	<input type="checkbox"/>	



■ = Available on all models.

□ = Available on most models; consult factory for exceptions.

Order RELOC wiring with lay-in troffers and parabolics for use in buildings, schools and retail stores. Access plates have one pre-punched knockout to speed up installation. UL Listed autoground. Fixtures are automatically grounded as soon as the access plate is snapped in place. No ground leads

to connect. Auto-latching springs allow for an easy, secure connection and prevent accidental disengagement. Order RELOC factory wiring options for recessed ceiling and open ceiling applications.



RELOC					
Recessed & Open Ceiling		RRL Standard Wiring Instructions		Add to Fixture Description	Product Detail
RRL - RELOC Ready Luminaire					
RRL	Ballast/Driver wired to Pin Position #1 (Phase A)			RRLA	Touch-safe design meets UL/CSA requirement Wiping contact design allows safe disconnect under load Mating connector must be ordered with RELOC cable
	Ballast/Driver wired to Pin Position #2 (Phase B)			RRLB	
	Ballast/Driver wired to Pin Position #3 (Phase C)			RRLC	
	Outboard Ballast/Driver wired to Pin Position #1 (Phase A)			RRLAB	
	Inboard Ballast/Driver wired to Pin Position #2 (Phase B)				
	Ballast/Driver wired to Pin Position #1 (Phase A)			RRLAE	
	Emergency Ballast/Driver wired to Pin Position #2 (Phase B)			RRLABE	
	Ballast/Driver wired to Pin Position #1 (Phase A)				
	Ballast/Driver wired to Pin Position #2 (Phase B)				
	Emergency Ballast/Driver wired to Pin Position #3 (Phase C)			C12S	
Ballast/Driver wired to Pin Position #1 (Phase A)					
Low Voltage wire (Positive Purple)(Data1) wired to Pin Position #2					
Low Voltage wire (Common Gray)(Data2) wired to Pin Position #3					
Recessed Ceiling	Series	RELOC Cable Attached to Fixture	Quick Flex and System 820 Standard Wiring Instructions	Add to Fixture Description	Product Detail
Quick-Flex	QFC	12/2G	Ballast/Driver wired to Hot #1 (Phase A)	QFC2_A	RELOC cable is prewired to the fixture in the factory and shipped together. Available in varying lengths to suit most common fixture spacing requirements. Cable length must be specified (QFC211A or SSCD11A) UL Listed auto ground. No ground leads to connect
		12/3G	Ballast/Driver wired to Hot #1 (Phase A), Cap Hot #2	QFC3_A	
		12/3G	Ballast/Driver wired to Hot #2 (Phase B), Cap Hot #1	QFC3_B	
		12/3G	Outboard Ballast/Driver wired to Hot #1 (Phase A) Inboard Ballast/Driver wired to Hot #2 (Phase B)	QFC3_AB	
		12/3G	Ballast/Driver wired to Hot #1 (Phase A) Emergency Ballast/Driver wired to Hot #2 (Phase B)	QFC3_AE	
System 820	SSC	D	Ballast/Driver wired Hot #1 (Phase A)	SSCD_A	
		E	Ballast/Driver wired to Hot #2 (Phase B), Cap Hot #1	SSCE_B	
		E	Outboard Ballast/Driver wired to Hot #1 (Phase A) Inboard Ballast/Driver wired to Hot #2 (Phase B)	SSCE_AB	
		E	Ballast/Driver wired to Hot #1 (Phase A) Emergency Ballast/Driver wired to Hot #2 (Phase B)	SSCE_AE	
		D	Ballast/Driver wired to Hot Conductor (Phase A)	SSC_C12S	
		Low Voltage wire (Positive Purple)(Data1) wired to Pin Position #2			