

Fittings and brackets

Material

Superstrut fittings and brackets are manufactured from hot rolled carbon steel.

Dimensions

The following standard dimensions apply to all fittings except as indicated on the individual drawings:

Hole spacing	$1\frac{3}{16}$ in. from end of fittings
Hole spacing	$1\frac{7}{8}$ in. centers
Hole size	$\frac{9}{16}$ in. diameter
Material	$1\frac{5}{8}$ in. wide
Material	$\frac{3}{4}$ in. thick

Application instructions

Parts drawings illustrate a typical use for the fitting, and in many cases, other uses for the part are appropriate.

Design data

Load ratings vary depending on whether fittings and brackets are used with 12, *14 or 16 gauge channel. Ratings are shown for each channel material. (See page 66 for engineering data and specifications).

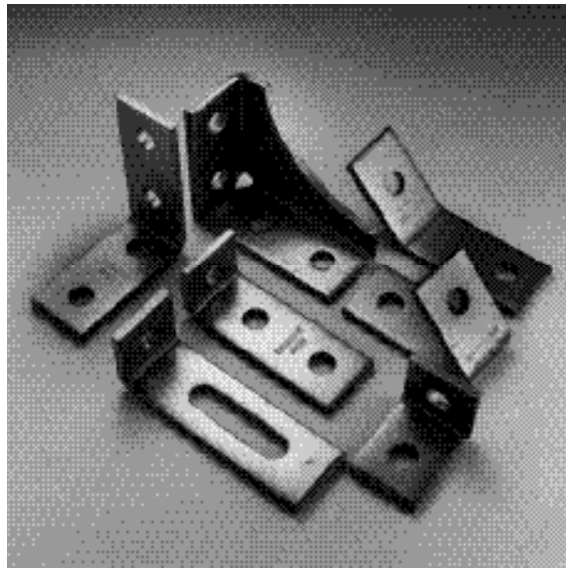

Nuts and bolts required

Unless otherwise noted, nuts and bolts for use with fittings and brackets should be ordered separately. The standard bolt for the $\frac{9}{16}$ in. hole is a $\frac{1}{2}$ in. hex head cap screw 1 in. long. The 1 in. length may be used with all series channel.

Design load

For more information on design load, see page 66 for engineering data and specifications.

Finishes and special materials

Standard finishes are hot-dipped galvanized (HDGC) and GoldGalv® (no suffix). Fittings are also available in electrogalvanized (EG) and stainless steel 316 (SS6C). Contact your regional sales office for availability and minimum quantities.

Aluminum channel

For aluminum channel, we suggest fittings in HDG (C) or SS6 (C).

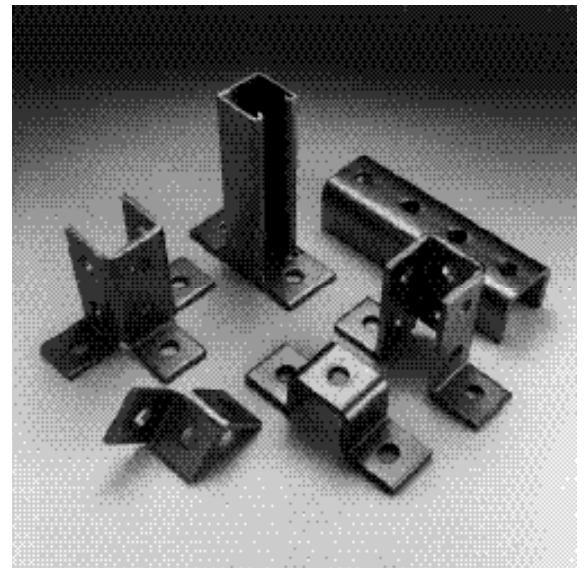

Fittings and brackets

Flat fittings

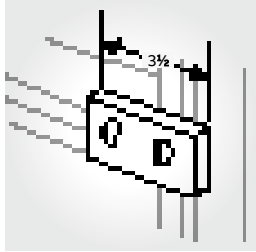

01

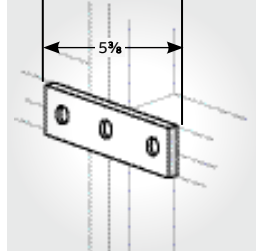

02

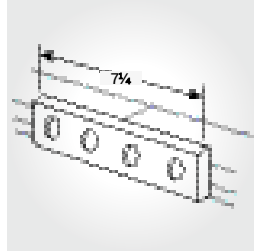

03

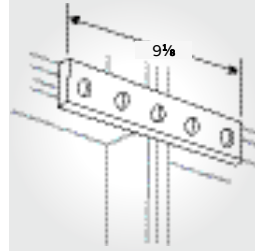

04

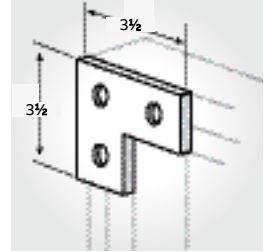

05

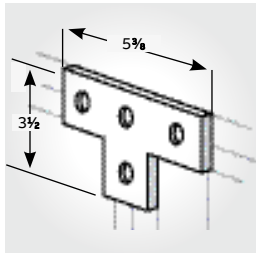

06

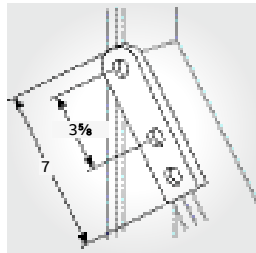

07

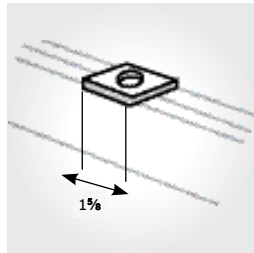

08

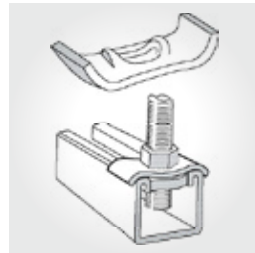

09

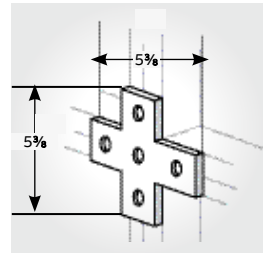

10

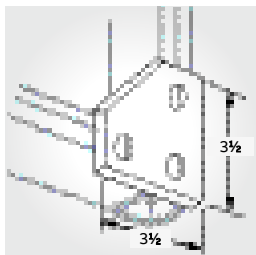

11

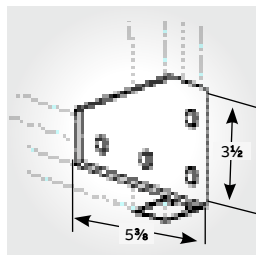

12

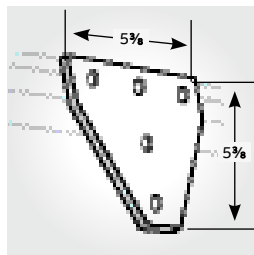

13

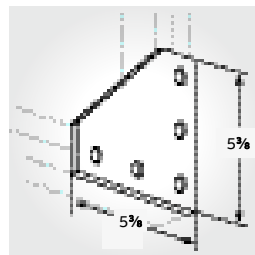

14

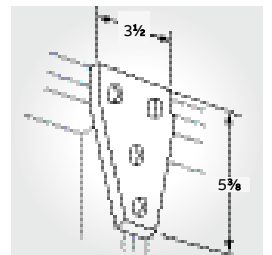

15

01 **AB206**
AB206HDGC
AB206EG
AB206
AB206SS6C
Wt./C 35 lb

02 **AB207**
AB207HDGC
AB207EG
AB207
AB207SS6C
Wt./C 52 lb

03 **X207**
X207HDG
X207EG
X207
X207SS6
Wt./C 78 lb

04 **X208**
X208HDG
X208EG
X208
X208SS6C
Wt./C 88 lb

05 **AB219**
AB219HDGC
AB219EG
AB219
AB219SS6C
Wt./C 53 lb

06 **AB220**
AB220HDGC
AB220EG
AB220
AB220SS6C
Wt./C 78 lb

07 **AB240**
AB240HDG
AB240EG
AB240
Wt./C 69 lb

08 **AB241**

Cat. no.	Bolt size (in.)	Wt./C lb
AB241-1/4*	1/4	18
AB241-5/16*	5/16	18
AB241-3/8*	3/8	18
AB241-1/2*	1/2	17
AB241-5/8*	5/8	15
AB241-3/4*	3/4	14

*Finishes
• HDGC
• EG
• GoldGalv®
• SS6C

09 **AB242**
AB242HDGC
AB242EG
AB242
Wt./C 9 lb
For use with either 3/8 in. or 1/2 in. hanger rod.

10 **AB253**
AB253HDGC
AB253EG
AB253
AB253SS6C
Wt./C 97 lb

11 **AB255**
AB255HDGC
AB255EG
AB255
Wt./C 70 lb

12 **AB257**
AB257HDGC
AB257EG
AB257
Wt./C 105 lb

13 **AB261**
AB261HDGC
AB261EG
AB261
Wt./C 148 lb

14 **AB263**
AB263HDGC
AB263EG
AB263
AB263SS6
Wt./C 150 lb

15 **AB265**
AB265HDGC
AB265EG
AB265
Wt./C 105 lb

Standard dimensions

Hole spacing	1 3/16 in. from end
Hole spacing	1 7/8 in. centers
Hole size	5/16 in. diam.
Material	1 1/8 in. width
Material	1/4 in. thick

Materials

HDG(C)	Hot-dipped galvanized
EG(C)	Electrogalvanized
(No suffix)	GoldGalv®
SS6(C)	Stainless steel 316

All dimensions shown are in in.

Fittings and brackets

90° fittings

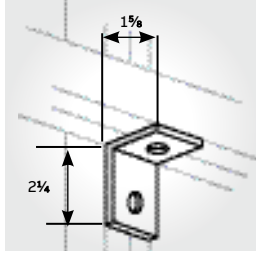

01

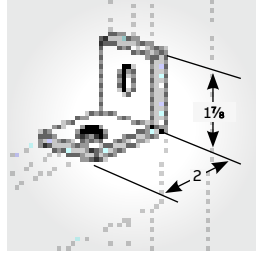

02

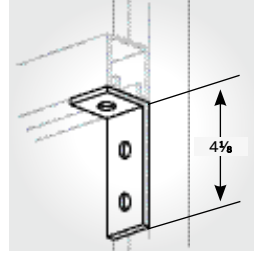

03

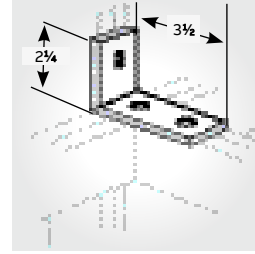

04

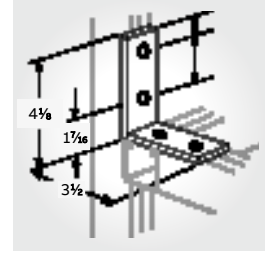

05

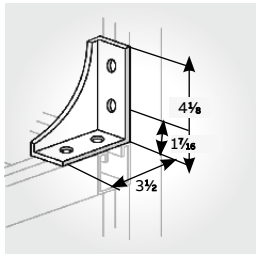

06

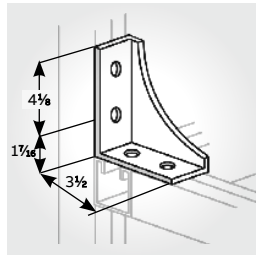

07

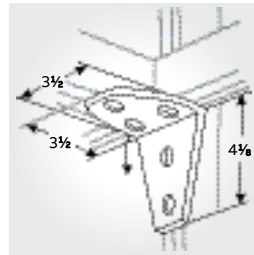

08

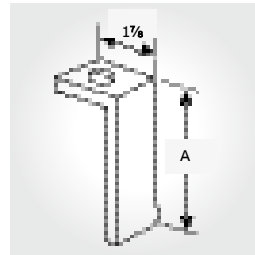

09

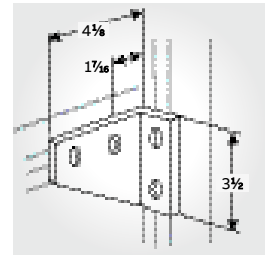

10

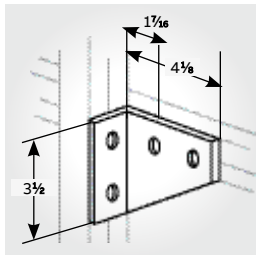

11

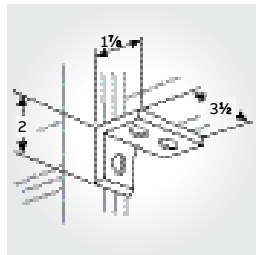

12

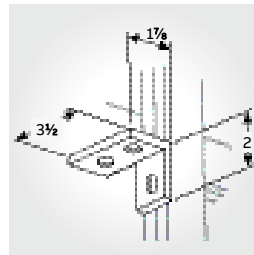

13

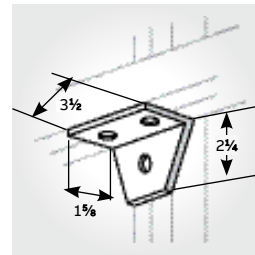

14

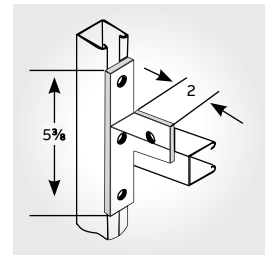

15

01 **AB201**
AB201HDGC
AB201EG
AB201
AB201SS6C
Wt./C 35 lb

02 **AB202**
AB202HDGC
AB202EG
AB202
AB202SS6C
Wt./C 35 lb

03 **AB203**
AB203HDGC
AB203EG
AB203
AB203SS6C
Wt./C 58 lb

04 **AB204**
AB204HDGC
AB204EG
AB204
AB204SS6
Wt./C 58 lb

05 **AB205**
AB205HDGC
AB205EG
AB205
AB205SS6C
Wt./C 78 lb

06 **AB213**
AB213HDGC
AB213EG
AB213
Wt./C 125 lb

07 **AB214**
AB214HDGC
AB214EG
AB214
AB214SS6
Wt./C 125 lb

08 **AB216**
AB216HDGC
AB216EG
AB216SS6C
Wt./C 135 lb

Cat. no.	A Wt./C	
	(in.)	lb
AB252-1*	3 3/8	61
AB252-2*	5 7/8	84
AB252-3*	7 7/8	107
AB252-4*	9 7/8	130

*Finishes
• HDGC
• EG
• GoldGalv®

10 **AB254R**
AB254RHDGC
AB254REG
AB254R
Wt./C 105 lb

11 **AB254L**
AB254LHDGC
AB254LEG
AB254L
Wt./C 105 lb

12 **AB260R**
AB260RHDGC
AB260REG
AB260R
Wt./C 58 lb

13 **AB260L**
AB260LHDGC
AB260LEG
AB260L
Wt./C 58 lb

14 **AB274**
AB274HDGC
AB274EG
AB274
Wt./C 70 lb

15 **AB275**
AB275HDGC
AB275EG
AB275SS6C
Wt./C 77 lb

Standard dimensions

Hole spacing	1 3/16 in. from end
Hole spacing	1 7/8 in. centers
Hole size	9/16 in. diam.
Material	1 1/8 in. width
Material	1/4 in. thick

Materials

HDG(C)	Hot-dipped galvanized
EG(C)	Electrogalvanized
(No suffix)	GoldGalv®
SS6(C)	Stainless steel 316

All dimensions shown are in in.

Fittings and brackets

90° fittings

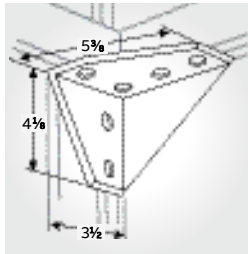

01

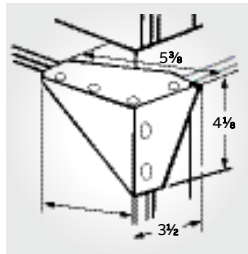

02

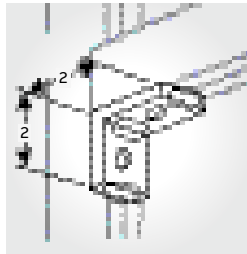

03

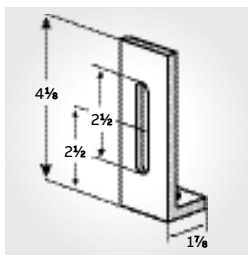

04

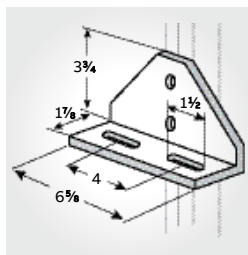

05

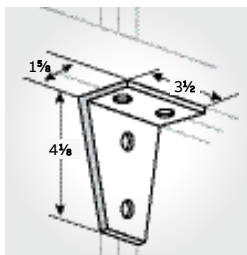

06

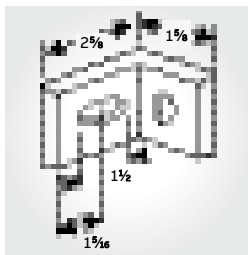

07

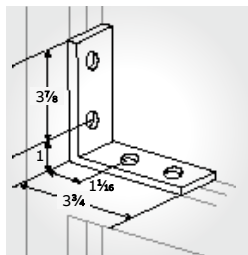

08

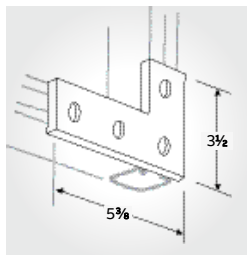

09

01 **AB284R**
AB284RHDG
AB284REG
AB284R
Wt./C 230 lb

02 **AB284L**
AB284LHDG
AB284LEG
AB284L
Wt./C 230 lb

03 **AB299**
AB299HDG
AB299EG
AB299
Wt./C 40 lb

04 **X201**
X201HDG
X201EG
X201
Wt./C 65 lb

05 **X204**
X204HDG
X204EG
X204
Wt./C 1-90 lb

06 **X289**
X289HDG
X289EG
X289
Wt./C 105 lb

07 **X299**
X299HDG
X299EG
X299
Wt./C 38 lb

08 **N205**
N205HDG
N205EG
N205
N205SS6C
Wt./C 74 lb

09 **N219**
N219HDG
N219EG
N219
N219SS6
Wt./C 71 lb

SuperMag™

Magnetic fittings for Superstrut metal framing

Powerful, nickel-plated magnets embedded in the most popular Superstrut steel fittings, including square washers, L-brackets, T-brackets and 90° angle brackets, secure the fitting to the strut during assembly. Acting as a third hand, SuperMag fittings allow the installer to work more efficiently and safely with tools and hardware.



Magnetic 90° angle fitting,

SilverGalv™

AB202M EG

2-hole, 1 7/8" H x 2" L (pkg. qty. 50)



AB205M EG

4-hole, 4 3/8" H x 3 1/2" L (pkg. qty. 25)



Magnetic flat bracket,

SilverGalv

AB219M EG

L-bracket (pkg. qty. 25)



AB220M EG

T-bracket (pkg. qty. 25)



Magnetic square washer

SilverGalv

AB241M 1/4 EG

For 1/4" bolt (pkg. qty. 100)

AB241M 3/8 EG

For 3/8" bolt (pkg. qty. 100)

AB241M 1/2 EG

For 1/2" bolt (pkg. qty. 100)

All dimensions shown are in in.

Note: The magnets are only intended for use as an installer aid, not as a permanent installation method on their own. Magnetic fittings must be bolted in place following the same standard installation procedures as non-magnetic fittings for permanent installation. Standard finish is SilverGalv (EG). Best for use with traditional or spring channel nuts.

Fittings and brackets

Angular and “Z” shape fittings

Angular fittings

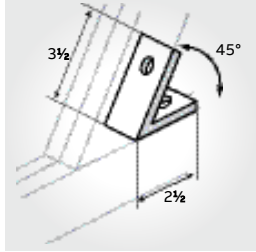

01

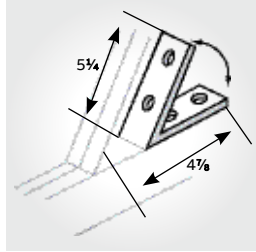

02

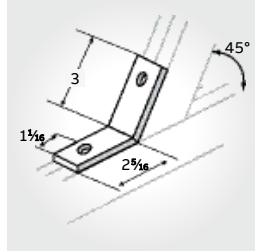

03

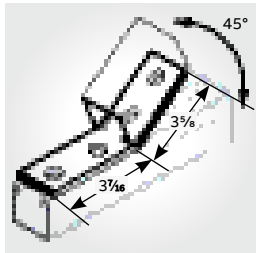

04

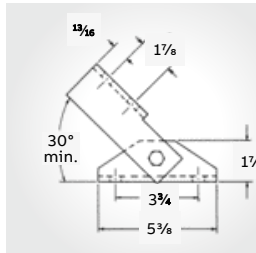

05

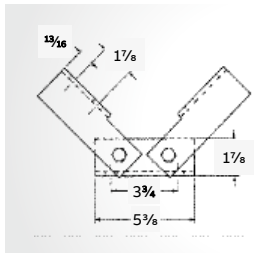

06

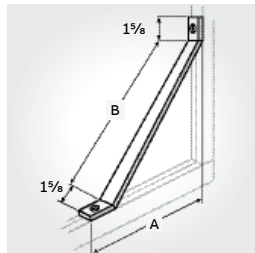
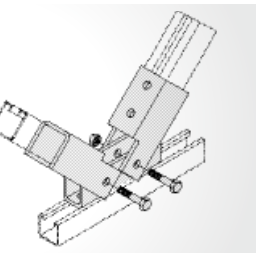

07

“Z” shape fittings

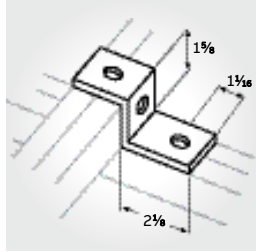

08

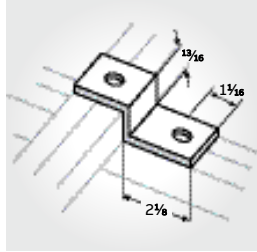

09

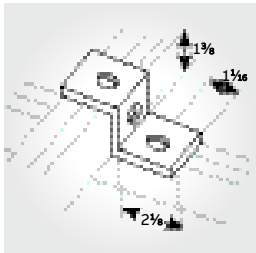

10

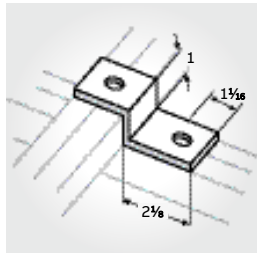

11

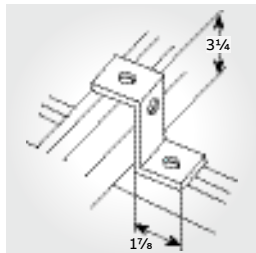

12

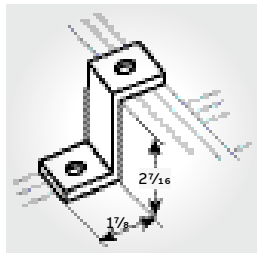

13

Angular fittings

- 01 **AB225**
AB225HDGC
AB225EG
AB225
AB225SS6
Wt./C 58 lb
Other angles available.
Contact your regional sales office.
- 02 **AB226**
AB226HDGC
AB226SS6
Wt./C 119 lb
Other angles available.
Contact your regional sales office.
- 03 **AB227**
AB227HDGC
AB227EG
AB227
AB227SS6
Wt./C 58 lb
Other angles available.
Contact your regional sales office.

- 04 **AB228**
AB228HDGC
AB228SS6C
Wt./C 69 lb
Other angles available.
Contact your regional sales office.
- 05 **AB231**
AB231EG
- 06 **AB232**
AB232EG
- 07 **AB239**
*Finishes
• HDGC
• EG
• GoldGalv®

“Z” shaped fittings

- 08 **A209**
A209HDGC
A209EG
A209
A209SS6
Wt./C 55 lb
For attaching A and AR series channel.
- 09 **B209**
B209HDG
B209EG
B209
Wt./C 43 lb
For attaching B and BR series channel.
- 10 **C209**
C209
Wt./C 49 lb
For attaching C series channel.
- 11 **D209**
Wt./C 45 lb
For attaching D series channel.
- 12 **CZ209**
For attaching H series and A back to back.
- 13 **EZ209**
EZ209HDGC
EZ209EG
EZ209
EZ209SS6
For attaching E series channel.

Cat. no.	A (in.)	B (in.)	Wt./C lb
AB239-1*	7 ¹³ / ₁₆	8½	148
AB239-2*	13¾	17	255
AB239-3*	19¾	25½	363

Standard dimensions

Hole spacing	1 ³ / ₁₆ in. from end
Hole spacing	1 ⁷ / ₁₆ in. centers
Hole size	5/16 in. diam.
Material	1 ⁵ / ₁₆ in. width
Material	¼ in. thick

Materials

HDG(C)	Hot-dipped galvanized
EG(C)	Electrogalvanized
(No suffix)	GoldGalv®
SS6(C)	Stainless steel 316

All dimensions shown are in in.

Fittings and brackets

“U” shape fittings

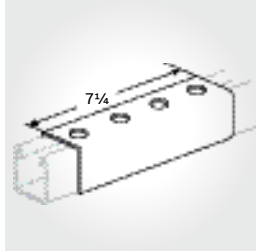

01

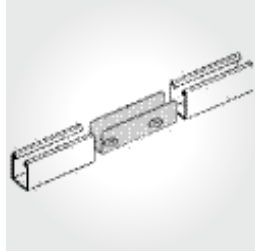

02

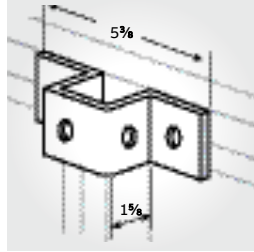

03

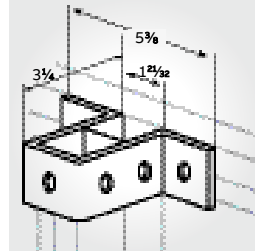

04

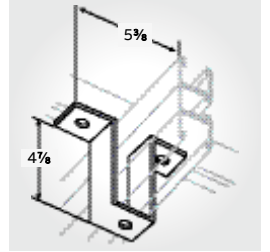

05

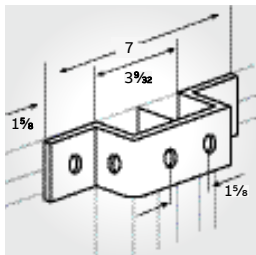

06

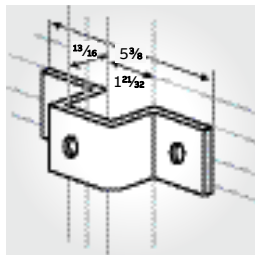

07

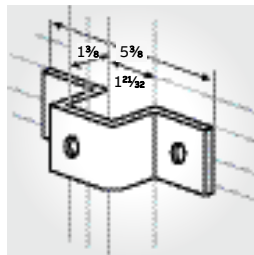

08

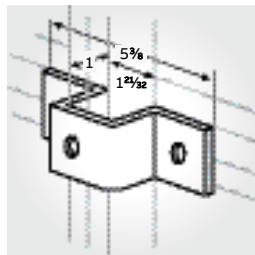

09

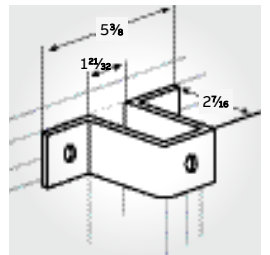

10

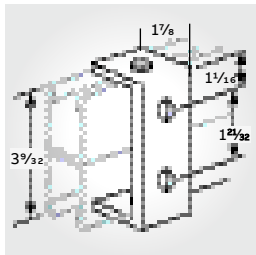

11

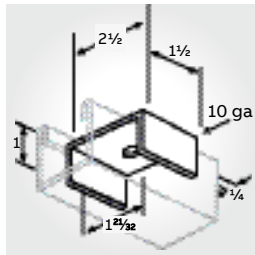

12

01 **A208**
A208HDGC
A208EG
A208
A208SS6C
Wt./C 275 lb
Does not include stud nut or bolts.
For A and AR series channel.

02 **A213 Inside joiner**
Wt./C 40 lb
For A1200 Series.
Available only in GoldGalv® finish.

03 **A210**
A210HDGC
A210EG
A210
A210SS6C
Wt./C 88 lb
For attaching A and AR series channel.

04 **A211**
A211HDGC
A211EG
A211
Wt./C 128 lb
For attaching A and AR series double channel, and H series.

05 **AN211**
AN211HDG
AN211EG
AN211
Wt./C 181 lb

06 **A212**
A212HDG
A212EG
A212
A212SS6
Wt./C 113 lb

07 **B210**
B210HDG
B210EG
B210
B210SS6
Wt./C 65 lb
For attaching B and BR series.

08 **C210**
C210HDG
C210EG
C210
Wt./C 77 lb
For attaching C series channel.

09 **D210**
D210HDG
D210EG
D210
D210SS6
Wt./C 71 lb
For attaching D series channel.

10 **E210**
E210HDGC
E210EG
E210
Wt./C 112 lb
For attaching E series channel.

11 **AB245**
AB245HDG
AB245EG
AB245
Wt./C 70 lb
For attaching A and AR series double channel.

12 **AB288**

Cat. No.	Bolt size (in.)	Wt./C lb
AB288-3/8*	3/8	37
AB288-1/2*	1/2	37
AB288-5/8*	5/8	37

*Finishes
• HDGC
• EG
• GoldGalv®

Standard dimensions

Hole spacing	1 3/16 in. from end
Hole spacing	1 7/8 in. centers
Hole size	5/16 in. diam.
Material	1 5/8 in. width
Material	1/4 in. thick

Materials

HDG(C)	Hot-dipped galvanized
EG(C)	Electrogalvanized
(No suffix)	GoldGalv®
SS6(C)	Stainless steel 316

All dimensions shown are in in.

Fittings and brackets

Wing fittings

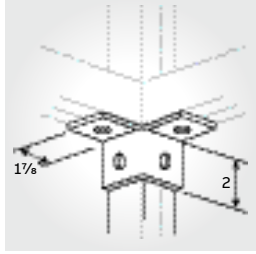

01

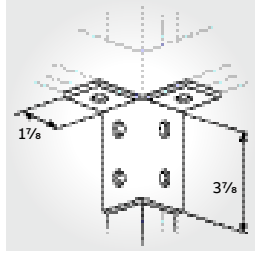

02

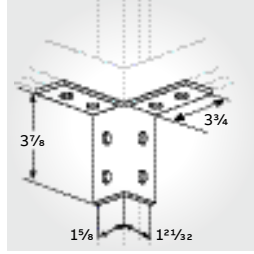

03

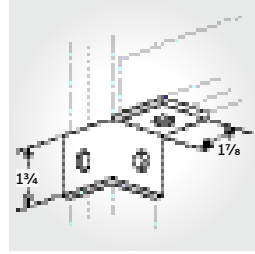

04

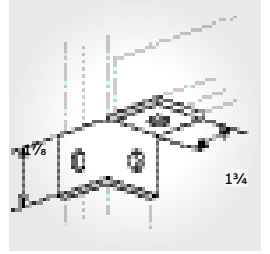

05

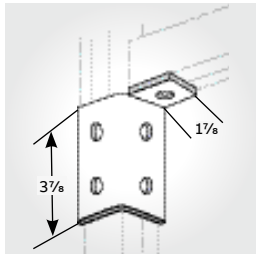

06

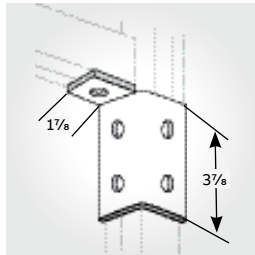

07

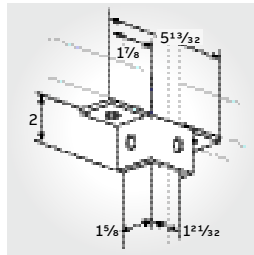

08

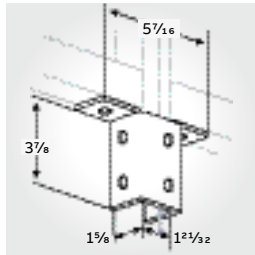

09

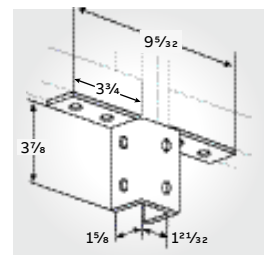

10

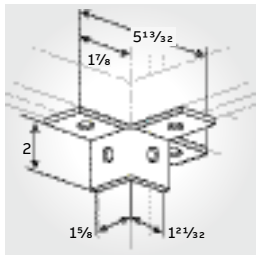

11

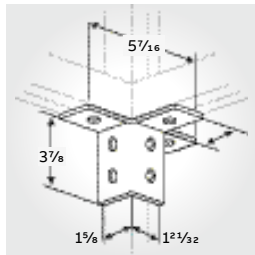

12

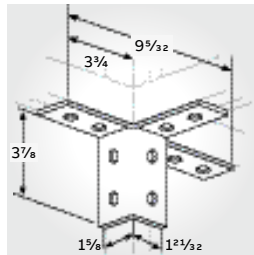

13

01 **AW204**
AW204HDG
AW204EG
AW204
Wt./C 76 lb

02 **AW214**
AW214HDG
AW214EG
AW214
Wt./C 115 lb

03 **A217**
AW217HDG
A217EG
A217
Wt./C 155 lb

04 **AW205L**
AW205LHDG
AW205LEG
AW205L
Wt./C 59 lb

05 **AW205R**
AW205REG
AW205R
Wt./C 59 lb

06 **AW215L**
AW215LHDG
AW215LEG
AW215L
Wt./C 98 lb

07 **AW215R**
AW215RHDG
AW215REG
AW215R
Wt./C 98 lb

08 **AW220**
AW220HDG
AW220EG
AW220
Wt./C 90 lb

09 **AW224**
AW224HDG
AW224EG
AW224
Wt./C 147 lb

10 **AW219**
AW219HDG
AW219EG
AW219
Wt./C 187 lb

11 **AW226**
AW226HDG
AW226
Wt./C 113 lb

12 **A218**
A218HDG
A218EG
A218
Wt./C 177 lb

13 **AW228**
AW228HDG
AW228EG
AW228
Wt./C 230 lb

Standard dimensions

Hole spacing	1 3/16 in. from end
Hole spacing	1 7/8 in. centers
Hole size	9/16 in. diam.
Material	1 1/8 in. width
Material	1/4 in. thick

Materials

HDG(C)	Hot-dipped galvanized
EG(C)	Electrogalvanized
(No suffix)	GoldGalv®
SS6(C)	Stainless steel 316

All dimensions shown are in in.

Fittings and brackets

Brackets

S202

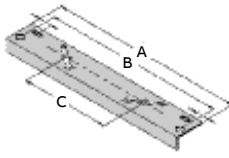
	Cat. no.	A (in.)	B (in.)	C (in.)	Wt./C lb
Diagram 	S202-6*	6	5	-	75
	S202-9*	9	8	2	100
	S202-15*	15	14	18	175
	S202-21*	21	20	14	250
	S202-27*	27	26	20	325
	S202-33*	33	32	26	400

*Finishes
• HDG

S249

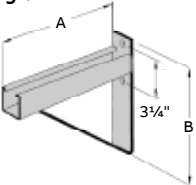
	Cat. no.	A (in.)	B (in.)	Design load/lb	Wt./C lb
Diagram 	S249-8*	8½	8	1,600	320
	S249-14*	14½	9	1,325	520
	S249-20*	20½	9	1,000	660

	Cat. no.	A (in.)	B (in.)	Design load/lb	Wt./C lb
Diagram 	S249-26*	26½	11½	850	870
	S249-32*	32½	11½	750	1,030
	S249-38*	38½	11½	600	1,230

*Finishes
• HDG
• SS6C

S251

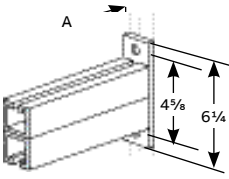
	Cat. no.	A (in.)	Design load/lb	Wt./C lb
Diagram 	S251-12*	12	1,650	514
	S251-14*	14½	1,650	514
	S251-18*	18	1,050	714
	S251-20*	20½	1,050	714
	S251-24*	24	800	914
	S251-26*	26½	800	914
	S251-30*	30	650	1,114
	S251-32*	32½	650	1,114
	S251-36*	36	500	1,314
	S251-38*	38½	500	1,314

*Finishes
• HDG
• SS6C

S203

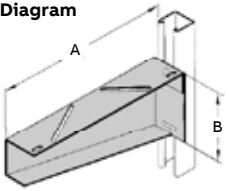
	Cat. no.	A (in.)	B (in.)	Design load/lb	Wt./C lb
Diagram 	S203-8*	8½	4½ ¹⁶	325	180
	S203-14*	14½	5¾	325	325
	S203-20*	20½	6 ¹¹ ₁₆	325	525
	S203-26*	26½	8	325	675
	S203-32*	32½	8	325	840
	S203-38*	38½	8	325	1,050

*Finishes
• HDG

S250

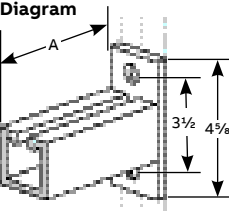
	Cat. no.	A (in.)	Design load/lb	Wt./C lb
Diagram 	S250-6*	6	1,500	150
	S250-8*	8½	1,500	150
	S250-12*	12	800	250
	S250-14*	14½	800	250
	S250-18*	18	550	350
	S250-20*	20½	550	350
	S250-24*	24	400	450
	S250-26*	26½	400	450

*Finishes
• HDG
• SS6C

May be installed inverted with no change in load ratings.

S256

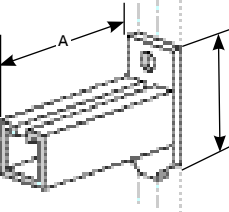
	Cat. no.	A (in.)	Design load/lb	Wt./C lb
Diagram 	S256-6*	6	1,000	151
	S256-8*	8½	1,000	151
	S256-12*	12	500	251
	S256-14*	14½	500	251
	S256-18*	18	300	351
	S256-20*	20½	300	351
	S256-24*	24	250	451
S256-26*	26½	250	451	

*Finishes
• HDG
• SS6C

When installed in inverted position reduce load rating 40%.

Standard dimensions	
Hole spacing	19/16 in. from end
Hole spacing	1 7/8 in. centers
Hole size	9/16 in. diam.
Material	1 1/8 in. width
Material	1/4 in. thick

Materials	
HDG(C)	Hot-dipped galvanized
EG(C)	Electrogalvanized
(No suffix)	GoldGalv®
SS6(C)	Stainless steel 316

Fittings and brackets

Brackets

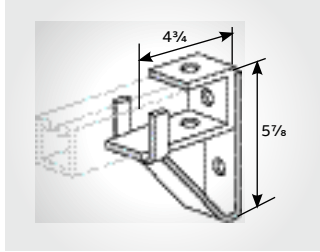

01

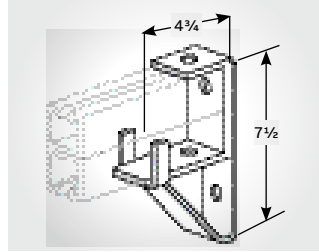

02

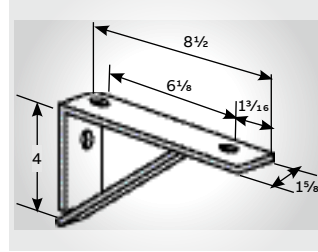

03

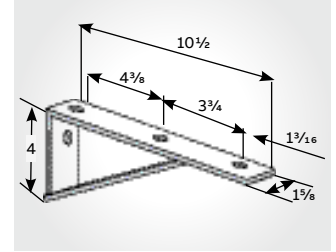

04

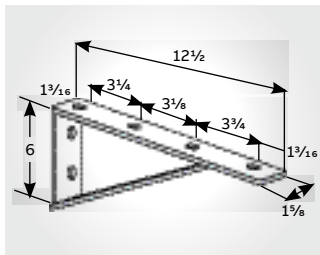

05

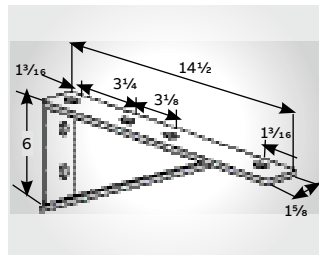

06

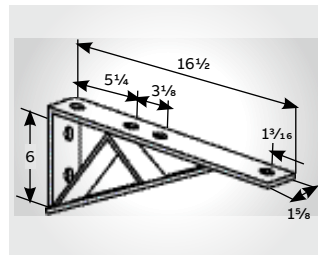

07

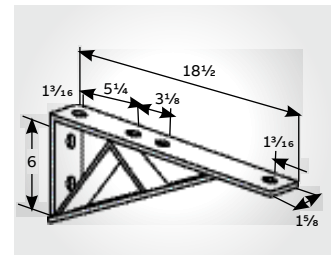

08

01 **S247**
S247HDG
S247
S247SS6
Design moment
(channel upright
as shown)
When supported by
A-1200 5,250 inch lb
A-1400 3,650 inch lb
Applies to fitting
only, not to the arm.

02 **S248**
S248HDG
S248
Design moment
(channel upright
as shown)
When supported by
A-1202 10,800 inch lb
A-1402 7,550 inch lb
Applies to fitting
only, not to the arm.

03 **S204**
S204HDG
S204
Wt./C 174 lb
**Design uniform
load/lb**
A-1200 750
A-1400 500

04 **S205**
S205HDG
S205
Wt./C 264 lb
**Design uniform
load/lb**
A-1200 750
A-1400 500

05 **S217**
S217HDG
S217
S217SS6
Wt./C 264 lb
**Design uniform
load/lb**
A-1200 750
A-1400 650

06 **S218**
S218HDG
S218
Wt./C 295 lb
**Design uniform
load/lb**
A-1200 750
A-1400 650

07 **S222**
S222HDG
S222
Wt./C 385 lb
**Design uniform
load/lb**
A-1200 1,000
A-1400 750

08 **S226**
S226HDG
S226
Wt./C 421 lb
**Design uniform
load/lb**
A-1200 1,000
A-1400 750

Standard dimensions	
Hole spacing	1 3/16 in. from end
Hole spacing	1 7/8 in. centers
Hole size	9/16 in. diam.
Material	1 5/8 in. width
Material	1/4 in. thick

Materials	
HDG(C)	Hot-dipped galvanized
EG(C)	Electrogalvanized
(No suffix)	GoldGalv®
SS6(C)	Stainless steel 316

All dimensions shown are in in.

Fittings and brackets

Post bases

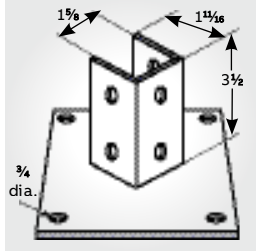

01

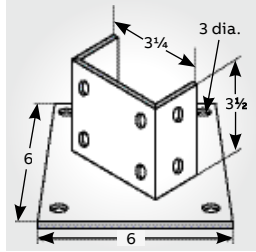

02

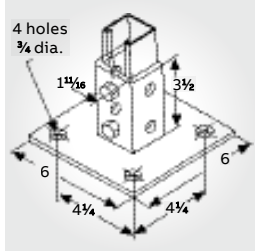

03

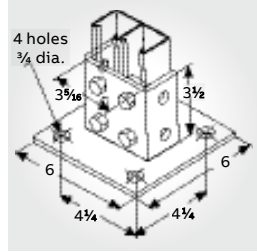

04

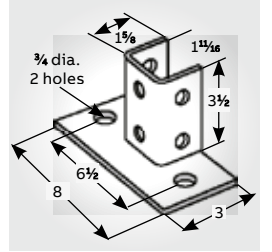

05

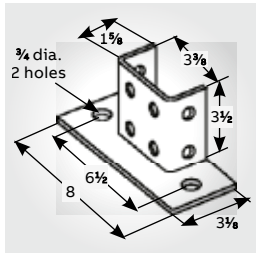

06

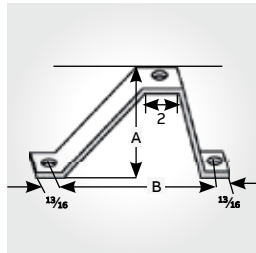

07

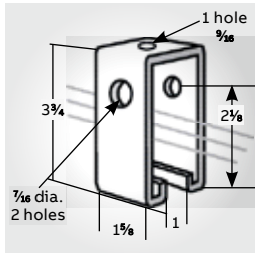

08

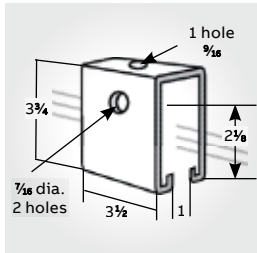

09

01 **AP232**
AP232HDGC
AP232EG
AP232
Wt./C 384 lb

02 **AP235**
AP235HDGC
AP235EG
AP235
Wt./C 400 lb

03 **AP232SQ**
AP232SQHDGC
AP232SQEG
AP232SQSS6
Wt./C 384 lb

04 **AP235SQ**
AP235SQHDGC
AP235SQEG
AP235SQ
AP235SQSS6
Wt./C 400 lb

05 **AP232FL**
AP232FLHDG
AP232FLEG
AP232FL
Wt./C 272 lb

06 **AP235FL**
AP235FLHDGC
AP235FLEG
AP235FL
Wt./C 360 lb

07 **AN270**
*Finishes
• HDG
• EG

08 **TS272 Track support**
TS272HDG
Requires 3/8 in. x 2 1/2 in. bolt and nut (not included)
Design load: 1,000 lb
Wt./C 104 lb

09 **TS273 Track support**
TS27
For use over channel splice
Requires 3/8 in. x 2 1/2 in. bolt and nut (not included)
Design load: 2,000 lb
Wt./C 228 lb

All dimensions shown are in in.

Cat. no.	A	B	Wt./C lb
AN270-1*	2 3/8	6	113
AN270-2*	4 3/8	8	151
AN270-3*	6 3/8	10	199
AN270-4*	8 3/8	12	246
AN270-5*	10 3/8	14	293

Fittings and brackets

Special application fittings and brackets

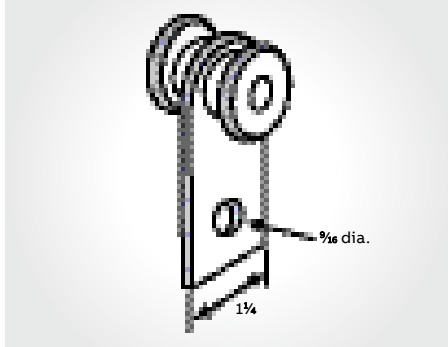

01

01 TR292
 Can be used for series A, E and H channels only.
 Standard finish is electrogalvanized.
 Frictionless needle bearings.
 Design load: 500 lb
 Safety factor of 5.
 Wt./C 59 lb

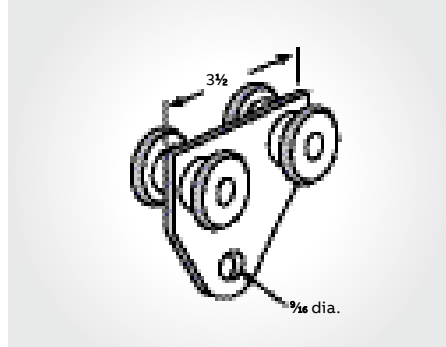

02

02 TR294
 Can be used for series A, E and H channels only.
 Standard finish is electrogalvanized.
 Frictionless needle bearings.
 Design load: 1,000 lb
 Safety factor of 5.
 Wt./C 106 lb

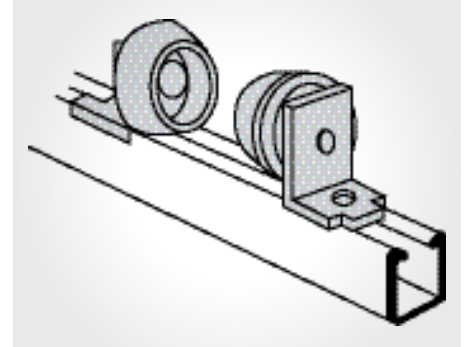

03

03 C728 Pipe roller (pair)
 Cast aluminum rollers, steel brackets. Designed for standard saddles. Order separately for each pair of rollers: two 1/2 in. x 3/16 in. hex head cap screws and two 1/2 in. channel nuts. Space to suit O.D. of pipe and wrapping.
 Design load: 2,350 lb
 Wt./C : 300 lb

Adjustable universal support

Support building services and access equipment on flat roofs and flat surfaces

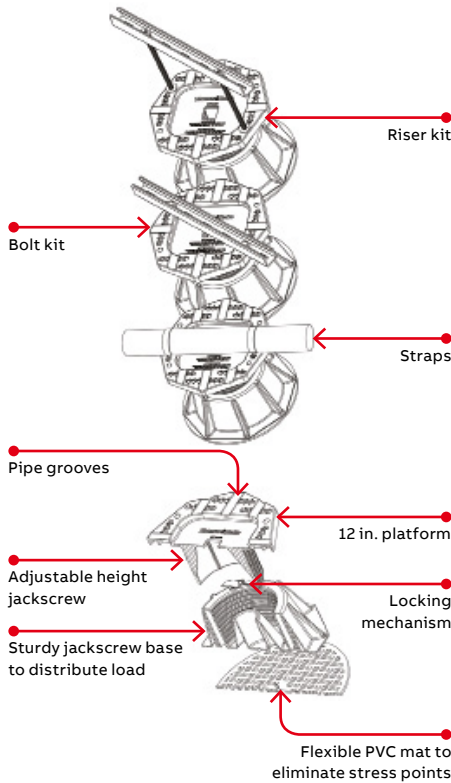

The ABB adjustable universal support (AUS) provides an easy method for supporting pipes, conduit and equipment on flat roofs, below raised floors and even on level ground applications. The AUS reduces installation time compared to other support solutions such as wooden blocks, cement blocks, straps and clips. These labor-intensive solutions also increase the danger of roof membrane penetration.

The AUS system allows for tool-free adjustment of the pedestal height from 6 to 9 inches with a twist of the wrist.

This ensures that the supported objects or pipes are uniformly supported and no high stress supports are carrying a disproportionate load in a single location.

Cat. no.	Description	Qty.
AUS14-96	Adjustable universal support (base only)	1
AUS-RISER-KIT	Riser kit	
A1200HS100PG	14 in. strut	1
H104-1/2X10EGC	12 in. threaded rod	2
E145-1/2EGC	Nut	8
E147-1/2EGC	Washer	8
E148-1/2EGC	Lock washer	4
AUS-STRUT-KIT	Bolt kit	
A1200HS100PG	14 in. strut	1
E142-1/2X200EGC	Bolt	2
E145-1/2EGC	Nut	2
E147-1/2EGC	Washer	4
E148-1/2EGC	Lock washer	2
AUS125PCSS6	4 1/2 in. stainless steel 316 strap (to restrain 1 1/4 in. pipe)	2
AUS150PCSS6	5 in. strap (to restrain 1 1/2 in. pipe)	2
AUS200PCSS6	6 in. strap (to restrain 2 in. pipe)	2