

Fittings and Brackets

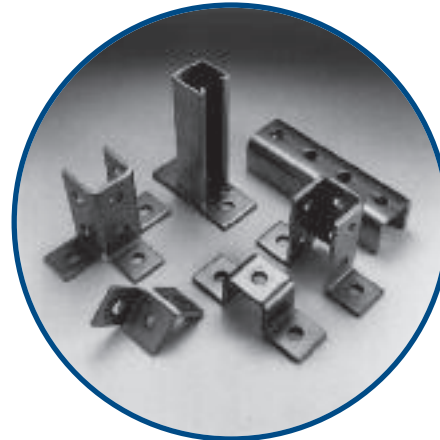
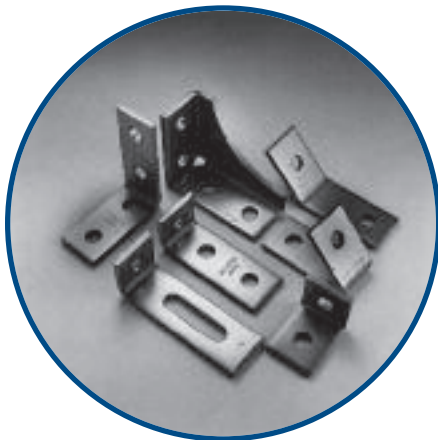

Material

Superstrut® fittings and brackets are manufactured from hot rolled carbon steel.

Dimensions

The following standard dimensions apply to all fittings except as indicated on the individual drawings.

Hole spacing	13/16 in. from end of fittings
Hole spacing	1-7/8 in. centers
Hole size	9/16 in. diameter
Material	1-5/8 in. wide
Material	1/4 in. thick

Application Instructions

Parts drawings illustrate a typical use for the fitting, and in many cases other uses for the part are appropriate.

Design Data

Load ratings vary depending fittings and brackets are used with 12, 14 or 16 gauge channel. Ratings are shown for each channel material. (See page A57 for Engineering Data and Specifications).

Nuts and Bolts Required

Unless otherwise noted, nuts and bolts for use with fittings and brackets should be ordered separately.

The standard bolt for the 9/16 in. hole is a 1/2 in. hex head cap screw 1 in. long. The 1 in. length may be used with all Series channel.

Design Load

For more information on design load, see page A57 Engineering Data and Specifications.

Finishes and Special Materials

Standard finishes are Hot Dipped Galvanized (HDGC) and GoldGalv® (no suffix). Fittings are also available in ElectroGalvanized (EG) and Stainless Steel 316 (SS6C). Contact your Regional Sales Office for availability and minimum quantities.

Aluminum channel

For Aluminum channel, we suggest fittings in HDG (C) or SS6 (C).

Fittings and Brackets

Flat Fittings

AB206

AB206HDGC
AB206EG
AB206
AB206SS6C
Wt./C 35 lb.

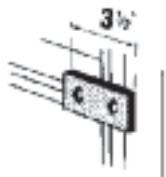

AB207

AB207HDGC
AB207EG
AB207
AB207SS6C
Wt./C 52 lb.

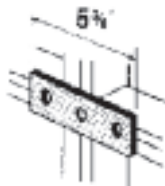

X207

X207HDG
X207EG
X207
X207SS6
Wt./C 78 lb.

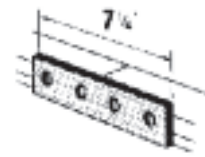

X208

X208HDG
X208EG
X208
X208SS6C
Wt./C 88 lb.

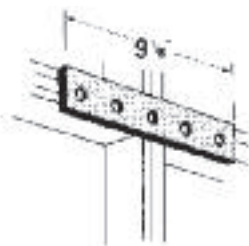

AB219

AB219HDGC
AB219EG
AB219
AB219SS6C
Wt./C 53 lb.

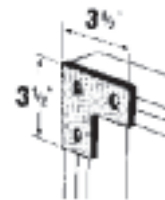

AB220

AB220HDGC
AB220EG
AB220
AB220SS6C
Wt./C 78 lb.

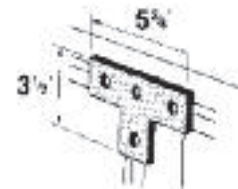

AB240

AB240HDG
AB240EG
AB240
Wt./C 69 lb.

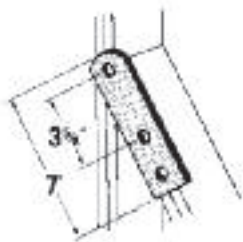

AB241

*Finishes
• HDGC
• EG
• GoldGalv®
• SS6C

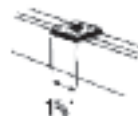

Cat. No.	Bolt Size (in.)	Wt./C lb.
AB241-1/4*	1/4	18
AB241-5/16*	5/16	18
AB241-3/8*	3/8	18
AB241-1/2*	1/2	17
AB241-5/8*	5/8	15
AB241-3/4*	3/4	14

AB242

AB242HDGC
AB242EG
AB242
Wt./C 9 lb.

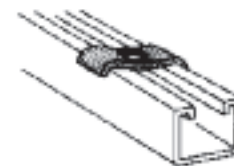

For use with either 3/8 in. or 1/2 in. hanger rod.

AB253

AB253HDGC
AB253EG
AB253
AB253SS6C
Wt./C 97 lb.

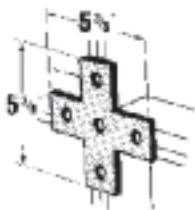

AB255

AB255HDGC
AB255EG
AB255
Wt./C 70 lb.

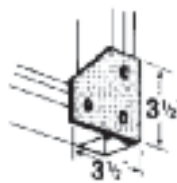

AB257

AB257HDGC
AB257EG
AB257
Wt./C 105 lb.

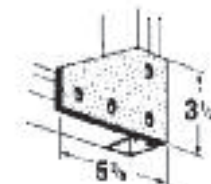

AB261

AB261HDGC
AB261EG
AB261
Wt./C 148 lb.

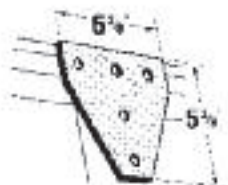

AB263

AB263HDGC
AB263EG
AB263
AB263SS6
Wt./C 150 lb.

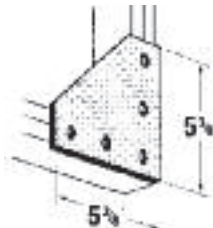

AB265

AB265HDGC
AB265EG
AB265
Wt./C 105 lb.

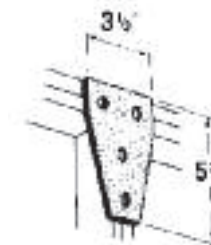

Standard Dimensions

Hole Spacing
Hole Spacing
Hole Size
Material
Material

13/16 in. From End
1-7/8 in. Centers
9/16 in. Diam.
1-5/8 in. Width
1/4 in. Thick

Materials

HDG(C)
EG(C)
(No suffix)
SS6(C)

Hot-Dipped Galvanized
ElectroGalvanized
GoldGalv®
Stainless Steel 316

Fittings and Brackets

90° Fittings

AB201

AB201HDGC

AB201EG

AB201

AB201SS6C

Wt./C 35 lb.

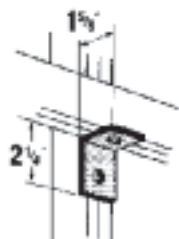

AB202

AB202HDGC

AB202EG

AB202

AB202SS6C

Wt./C 35 lb.

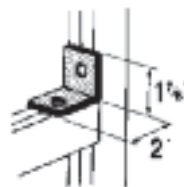

AB203

AB203HDGC

AB203EG

AB203

AB203SS6C

Wt./C 58 lb.

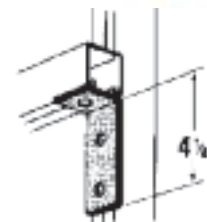

AB204

AB204HDGC

AB204EG

AB204

AB204SS6C

Wt./C 58 lb.

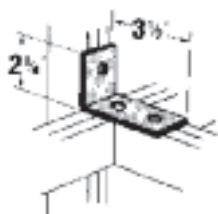

AB205

AB205HDGC

AB205EG

AB205

AB205SS6C

Wt./C 78 lb.

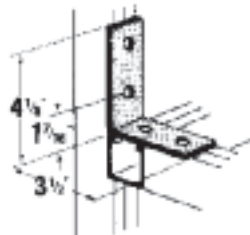

AB213

AB213HDGC

AB213EG

AB213

Wt./C 125 lb.

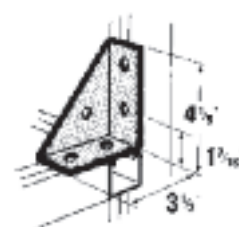

AB214

AB214HDGC

AB214EG

AB214

AB214SS6C

Wt./C 125 lb.

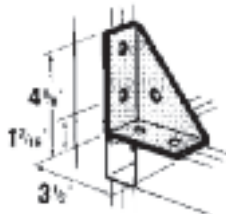

AB216

AB216HDGC

AB216EG

AB216SS6C

Wt./C 135 lb.

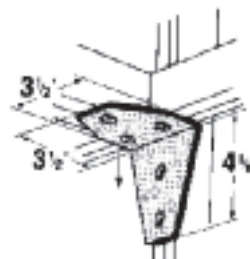

AB252



*Finishes

- HDGC
- GoldGalv®
- EG

Cat. No.	A (in.)	Wt./C lb.
AB252-1*	3-7/8	61
AB252-2*	5-7/8	84
AB252-3*	7-7/8	107
AB252-4*	9-7/8	130

AB254R

AB254RHDGC

AB254REG

AB254R

Wt./C 105 lb.

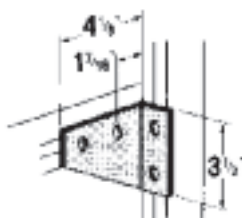

AB254L

AB254LHDGC

AB254LEG

AB254L

Wt./C 105 lb.

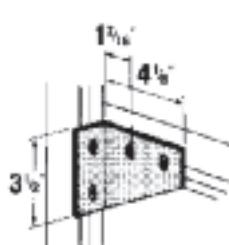

AB260R

AB260RHDGC

AB260REG

AB260R

Wt./C 58 lb.

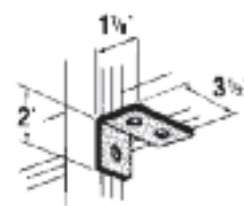

AB260L

AB260LHDGC

AB260LEG

AB260L

Wt./C 58 lb.

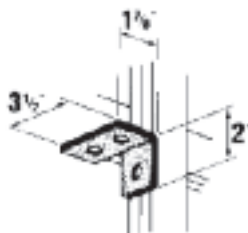

AB274

AB274HDG

AB274EG

AB274

Wt./C 70 lb.

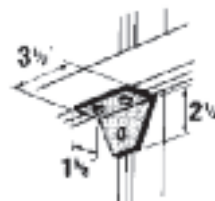

AB275

AB275HDGC

AB275EG

AB275SS6C

Wt./C 77 lb.

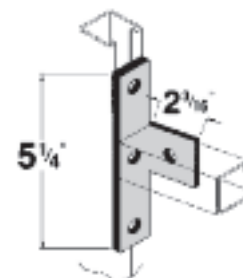

Standard Dimensions

Hole Spacing
Hole Spacing
Hole Size
Material
Material

13/16 in. From End
1-7/8 in. Centers
9/16 in. Diam.
1-5/8 in. Width
1/4 in. Thick

Materials

HDG(C)
EG(C)
(No suffix)
SS6(C)

Hot-Dipped Galvanized
ElectroGalvanized
GoldGalv®
Stainless Steel 316

Fittings and Brackets

90° Fittings

AB284R

AB284RHDG
AB284REG
AB284L
Wt./C 230 lb.

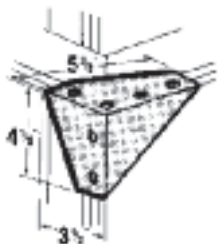

AB284L

AB284LHDG
AB284LEG
AB284L
Wt./C 230 lb.

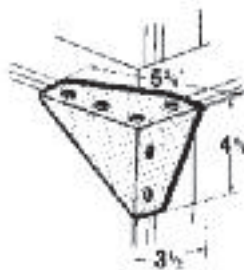

AB299

AB299HDG
AB299EG
AB299
Wt./C 40 lb.

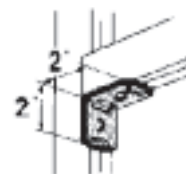

X201

X201HDG
X201EG
X201
Wt./C 65 lb.

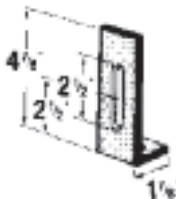

X204

X204HDG
X204EG
X204
Wt./C 90 lb.

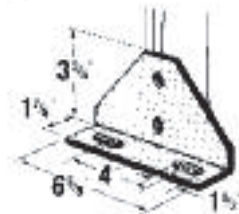

X289

X289HDGC
X289EG
X289
Wt./C 105 lb.

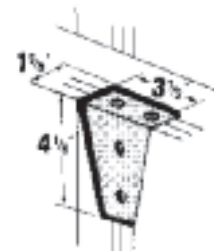

X299

X299HDGC
X299EG
X299
Wt./C 38 lb.



N205

N205HDGC
N205EG
N205
N205SS6C
Wt./C 74 lb.

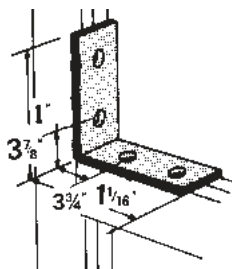

N219

N219HDG
N219EG
N219
N219SS6
Wt./C 71 lb.

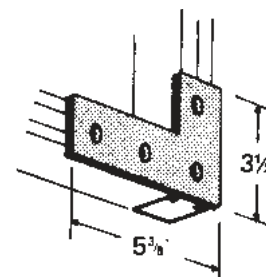

Standard Dimensions

Hole Spacing 13/16 in. From End
Hole Spacing 1-7/8 in. Centers
Hole Size 9/16 in. Diam.
Material 1-5/8 in. Width
Material 1/4 in. Thick

Materials

HDG(C)
EG(C)
(No suffix)
SS6(C)

Hot-Dipped Galvanized
ElectroGalvanized
GoldGalv®
Stainless Steel 316

Fittings and Brackets

Angular Fittings

AB225

AB225HDGC
AB225EG
AB225
AB225SS6
Wt./C 58 lb.

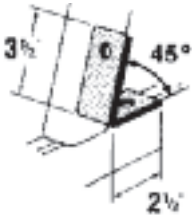

Other angles available. Contact your Regional Sales Office.

AB226

AB226HDGC
AB226SS6
Wt./C 119 lb.

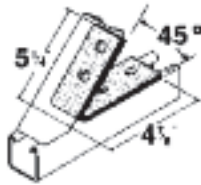

Other angles available. Contact your Regional Sales Office.

AB227

AB227HDGC
AB227EG
AB227
AB227SS6
Wt./C 58 lb.

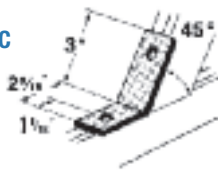

Other angles available. Contact your Regional Sales Office.

AB228

AB228HDGC
AB228SS6
Wt./C 69 lb.

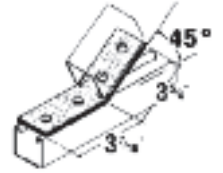

Other angles available. Contact your Regional Sales Office.

AB231

AB231EG

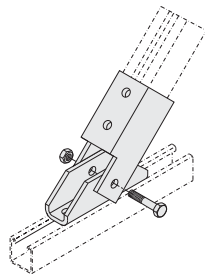
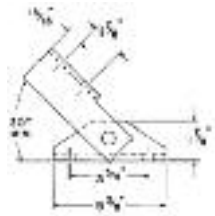

AB232

AB232EG

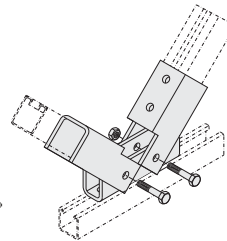
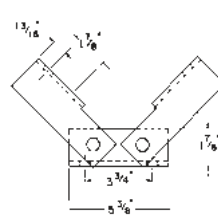

AB239

*Finishes

- HDGC
- GoldGalv®
- EG



Cat. No.	A (in.)	B (in.)	Wt./C lb.
AB239-1*	7-13/16	8-1/2	148
AB239-2*	13-3/4	17	255
AB239-3*	19-3/4	25-1/2	363

"Z" Shape Fittings

A209

A209HDGC
A209EG
A209
A209SS6
Wt./C 55 lb.

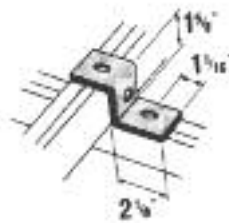

For attaching A and AR Series channel.

B209

B209HDG
B209EG
B209
Wt./C 43 lb.

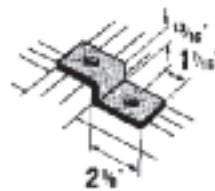

For attaching B and BR Series channel.

C209

C209
Wt./C 49 lb.

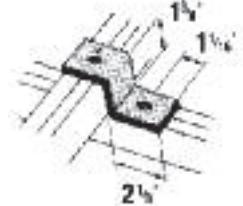

For attaching C Series channel.

D209

Wt./C 45 lb.

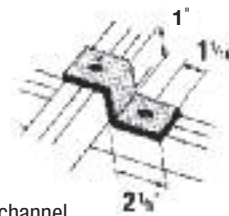

For attaching D Series channel.

CZ209

For attaching H Series and A back to back.

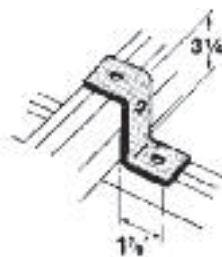

EZ209

EZ209HDGC
EZ209EG
EZ209
EZ209SS6

For attaching E Series channel.

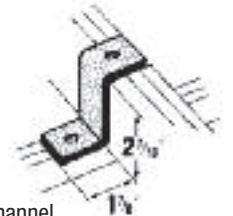

Standard Dimensions

Hole Spacing
Hole Spacing
Hole Size
Material
Material

13/16 in. From End
1-7/8 in. Centers
9/16 in. Diam.
1-5/8 in. Width
1/4 in. Thick

Materials

HDG(C)
EG(C)
(No suffix)
SS6(C)

Hot-Dipped Galvanized
ElectroGalvanized
GoldGalv®
Stainless Steel 316

Fittings and Brackets

"U" Shape Fittings

A208

A208HDGC
A208EG
A208
A208SS6C

Wt./C 275 lb.

Does not include stud nut or bolts.

For A and AR Series channel.

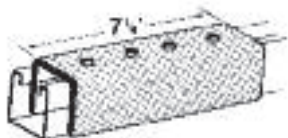

A213 Inside Joiner

Wt./C 40 lb.

For A1200 Series.

Available only in GoldGalv® finish.

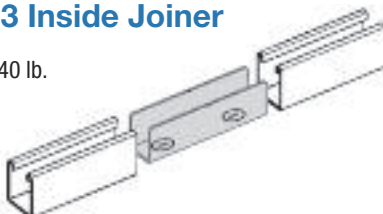

A210

A210HDGC
A210EG
A210
A210SS6C

Wt./C 88 lb.

For attaching A and AR Series channel.

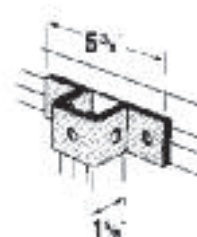

A211

A211HDGC
A211EG
A211

Wt./C 128 lb.

For attaching A and AR Series double channel, and H Series.

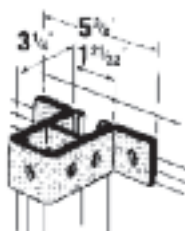

AN211

AN211HDG
AN211EG
AN211

Wt./C 181 lb.

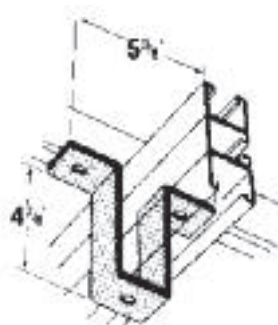

A212

A212HDG
A212EG
A212
A212SS6

Wt./C 113 lb.

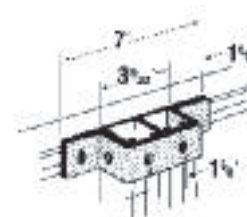

B210

B210HDG
B210EG
B210
B210SS6

Wt./C 65 lb.

For attaching B and BR Series.

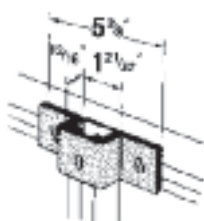

C210

C210HDG
C210EG
C210

Wt./C 77 lb.

For attaching C Series channel.

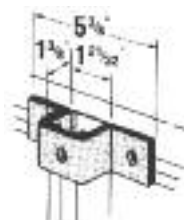

D210

D210HDG
D210EG
D210
D210SS6

Wt./C 71 lb.

For attaching D Series channel.

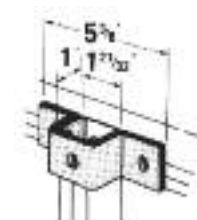

E210

E210HDGC
E210EG
E210

Wt./C 112 lb.

For attaching E Series channel.

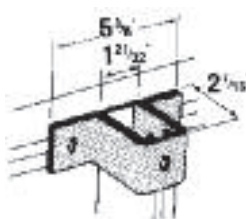

AB245

AB245HDG
AB245EG
AB245

Wt./C 70 lb.

For attaching A and AR Series double channel.

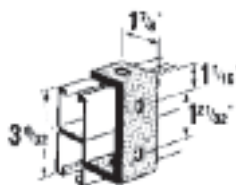

AB288

*Finishes

- HDGC
- GoldGalv®
- EG

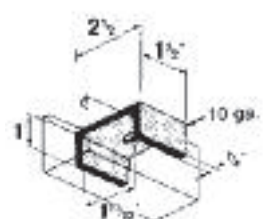

Cat. No.	Bolt Size (in.)	Wt./C lb.
AB288-3/8*	3/8	37
AB288-1/2*	1/2	
AB288-5/8*	5/8	

Standard Dimensions

Hole Spacing 13/16 in. From End
Hole Spacing 1-7/8 in. Centers
Hole Size 9/16 in. Diam.
Material 1-5/8 in. Width
Material 1/4 in. Thick

Materials

HDG(C)
EG(C)
(No suffix)
SS6(C)

Hot-Dipped Galvanized
ElectroGalvanized
GoldGalv®
Stainless Steel 316

Fittings and Brackets

Wing Fittings

AW204

AW204HDG

AW204EG

AW204

Wt./C 76 lb.

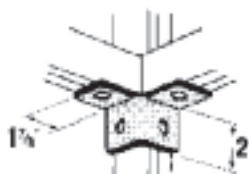

AW214

AW214HDG

AW214EG

AW214

Wt./C 115 lb.

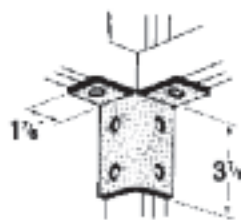

A217

AW217HDG

A217EG

A217

Wt./C 155 lb.

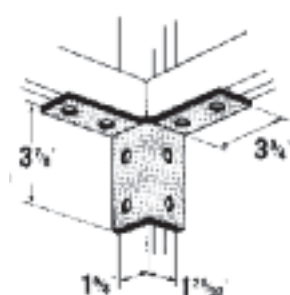

AW205L

AW205LHDG

AW205LEG

AW205L

Wt./C 59 lb.



AW205R

AW205REG

AW205R

Wt./C 59 lb.

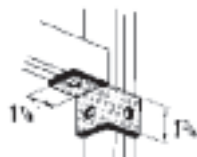

AW215L

AW215LHDG

AW215LEG

AW215L

Wt./C 98 lb.

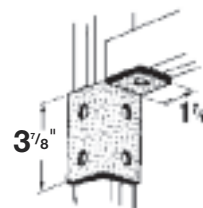

AW215R

AW215RHDG

AW215REG

AW215R

Wt./C 98 lb.

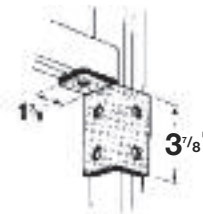

AW220

AW220HDGC

AW220EG

AW220

Wt./C 90 lb.

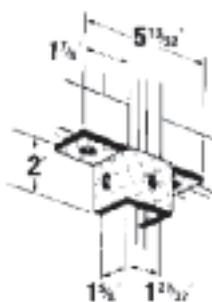

AW224

AW224HDGC

AW224EG

AW224

Wt./C 147 lb.

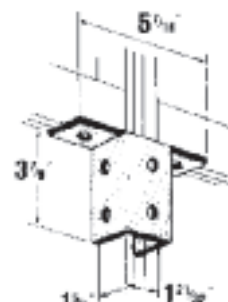

AW219

AW219HDGC

AW219EG

AW219

Wt./C 187 lb.

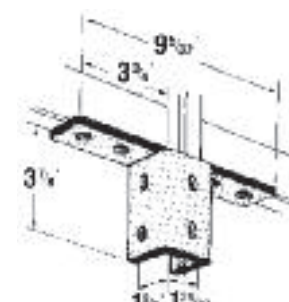

AW226

AW226HDG

AW226

Wt./C 113 lb.

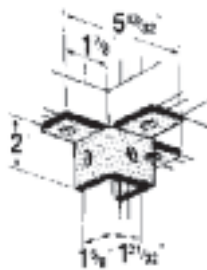

A218

A218HDG

A218EG

A218

Wt./C 177 lb.

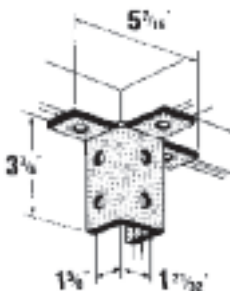

AW228

AW228HDG

AW228EG

AW228

Wt./C 230 lb.

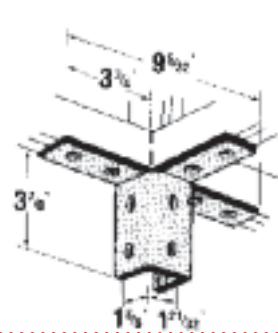

Standard Dimensions

Hole Spacing
Hole Spacing
Hole Size
Material
Material

13/16 in. From End
1-7/8 in. Centers
9/16 in. Diam.
1-5/8 in. Width
1/4 in. Thick

Materials

HDG(C)
EG(C)
(No suffix)
SS6(C)

Hot-Dipped Galvanized
ElectroGalvanized
GoldGalv®
Stainless Steel 316

Fittings and Brackets

Brackets

S202

- *Finishes
- HDG

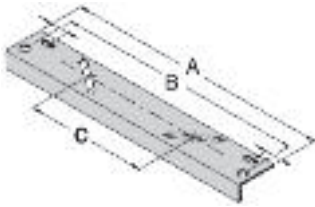

Cat. No.	A (in.)	B (in.)	C (in.)	Wt./C lb.
S202-6*	6	5	—	75
S202-9*	9	8	2	100
S202-15*	15	14	8	175
S202-21*	21	20	14	250
S202-27*	27	26	20	325
S202-33*	33	32	26	400

S203

- *Finishes
- HDG

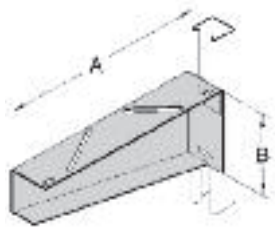

Cat. No.	A (in.)	B (in.)	Design Load/lb.	Wt./C lb.
S203-8*	8-1/2	4-1/16	1200	180
S203-14*	14-1/2	5-3/8		325
S203-20*	20-1/2	6-11/16		525
S203-26*	26-1/2	8		675
S203-32*	32-1/2	8		840
S203-38*	38-1/2	8		1050

S249

- *Finishes
- HDG
 - SS6C

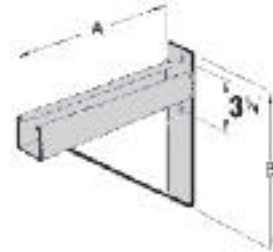

Cat. No.	A (in.)	B (in.)	Design Load/lb.	Wt./C lb.
S249-8*	8-1/2	8	1500	320
S249-14*	14-1/2	9		520
S249-20*	20-1/2	9		660
S249-26*	26-1/2	11-1/2		870
S249-32*	32-1/2	11-1/2		1030
S249-38*	38-1/2	11-1/2		1230

S250

- *Finishes
- HDG
 - SS6C

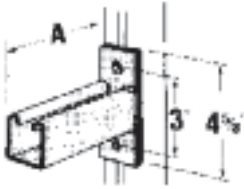

Cat. No.	A (in.)	Design Load/lb.	Wt./C lb.
S250-6*	6	1500	150
S250-8*	8-1/2	1500	150
S250-12*	12	800	250
S250-14*	14-1/2	800	250
S250-18*	18	550	350
S250-20*	20-1/2	550	350
S250-24*	24	400	450
S250-26*	26-1/2	400	450

May be installed inverted with no change in load ratings.

S251

- *Finishes
- HDG
 - SS6C

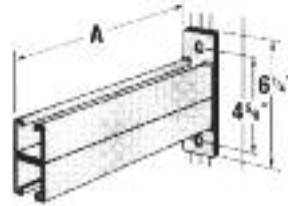

Cat. No.	A (in.)	Design Load/lb.	Wt./C lb.
S251-12*	12	1650	514
S251-14*	14-1/2	1650	514
S251-18*	18	1050	714
S251-20*	20-1/2	1050	714
S251-24*	24	800	914
S251-26*	26-1/2	800	914
S251-30*	30	650	1114
S251-32*	32-1/2	650	1114
S251-36*	36	500	1314
S251-38*	38-1/2	500	1314

S256

- *Finishes
- HDG
 - SS6C

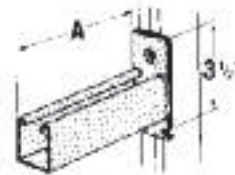

Cat. No.	A (in.)	Design Load/lb.	Wt./C lb.
S256-6*	6	1000	151
S256-8*	8-1/2	1000	151
S256-12*	12	500	251
S256-14*	14-1/2	500	251
S256-18*	18	300	351
S256-20*	20-1/2	300	351
S256-24*	24	250	451
S256-26*	26-1/2	250	451

When installed in inverted position reduce load rating 40%.

S247

- S247HDG
S247
S247SS6

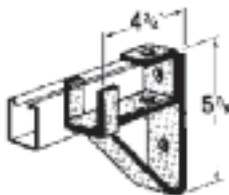

Design Moment
(channel upright as shown)
When Supported By
A-1200 5250 inch lb.
A-1400 3650 inch lb.

Applies to fitting only, not to the arm.

S248

- S248HDGC
S248

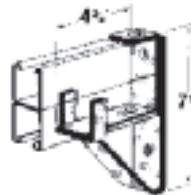

Design Moment
(channel upright as shown)
When Supported By
A-1202 10 800 inch lb.
A-1402 7550 inch lb.

Applies to fitting only, not to the arm.

Standard Dimensions

Hole Spacing
Hole Spacing
Hole Size
Material
Material

13/16 in. From End
1-7/8 in. Centers
9/16 in. Diam.
1-5/8 in. Width
1/4 in. Thick

Materials

HDG(C)
EG(C)
(No suffix)
SS6(C)

Hot-Dipped Galvanized
ElectroGalvanized
GoldGalv®
Stainless Steel 316

Fittings and Brackets

Brackets

S204

S204HDGC

S204

Wt./C 174 lb.

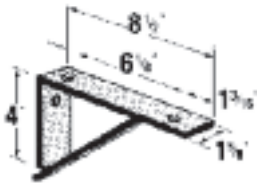

Design Uniform Load/lb.	
A-1200	750
A-1400	500

S205

S205HDGC

S205

Wt./C 264 lb.

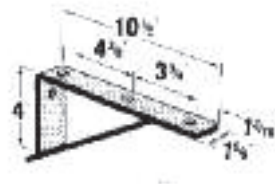

Design Uniform Load/lb.	
A-1200	750
A-1400	500

S217

S217HDG

S217

S217SS6

Wt./C 264 lb.

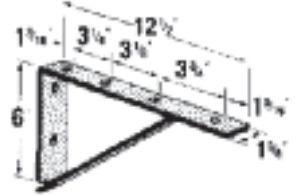

Design Uniform Load/lb.	
A-1200	750
A-1400	650

S218

S218HDG

S218

Wt./C 295 lb.

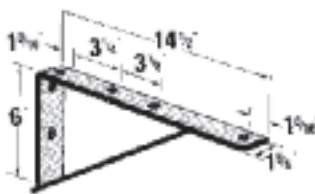

Design Uniform Load/lb.	
A-1200	750
A-1400	650

S222

S222HDG

S222

Wt./C 385 lb.

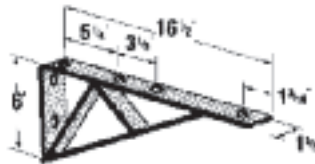

Design Uniform Load/lb.	
A-1200	1000
A-1400	750

S226

S226HDG

S226

Wt./C 421 lb.

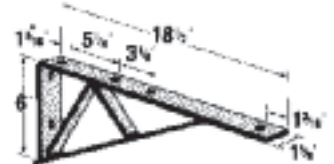

Design Uniform Load/lb.	
A-1200	1000
A-1400	750

Fittings and Brackets

Post Bases

AP232

AP232HDGC

AP232EG

AP232

Wt./C 384 lb.

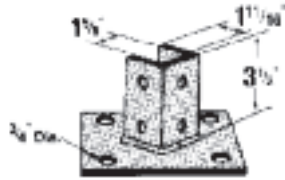

AP235

AP235HDGC

AP235EG

AP235

Wt./C 400 lb.

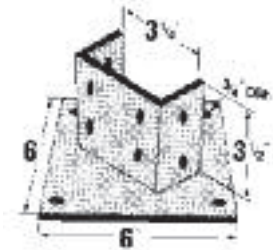

AP232SQ

AP232SQHDGC

AP232SQEG

AP232SQSS6

Wt./C 384 lb.

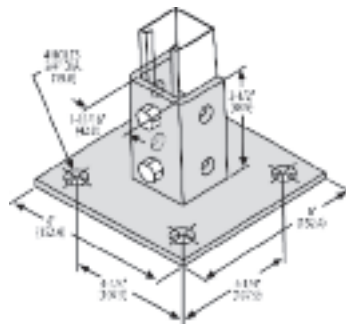

AP235SQ

AP235SQHDGC

AP235SQEG

AP235SQ

AP235SQSS6

Wt./C 400 lb.

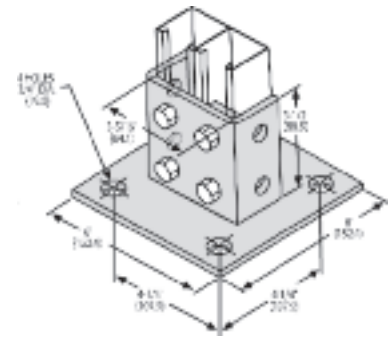

AN270

*Finishes

- HDG
- EG

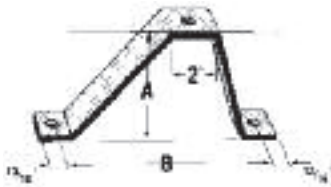

TS272 Track Support

TS272HDG

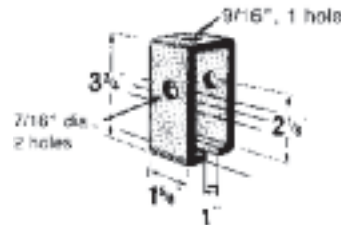

TS273 Track Support

TS273HDG

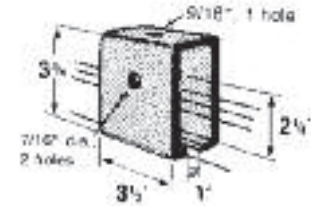

Cat. No.	A	B	Wt./C lb.
AN270-1*	2-3/8	6	113
AN270-2*	4-3/8	8	151
AN270-3*	6-3/8	10	199
AN270-4*	8-3/8	12	246
AN270-*	10-3/8	14	293

Requires 3/8 in. x 2-1/2 in. bolt and nut (not included)

Design load: 1000 lb.

Wt./C 104 lb.

For use over channel splice

Requires 3/8 in. x 2-1/2 in. bolt and nut (not included)

Design load: 2000 lb.

Wt./C 228 lb.

Fittings and Brackets

Special Application Fittings and Brackets

TR292

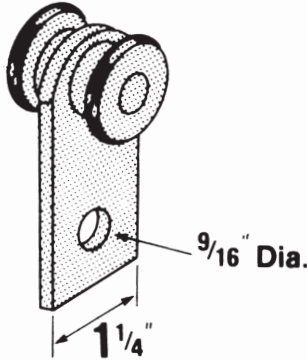

Can be used for Series A, E and H channels only.

Standard finish is Electrogalvanized.

Frictionless needle bearings.

Design load: 500 lb.

Safety factor of 5.

Wt./C 59 lb.

TR294

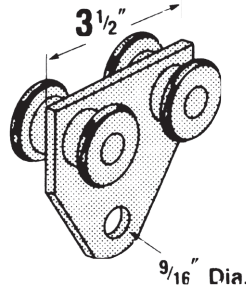

Can be used for Series A, E and H channels only.

Standard finish is Electrogalvanized.

Frictionless needle bearings.

Design load: 1000 lb.

Safety factor of 5.

Wt./C 106 lb.

C728 Pipe Roller (Pair)

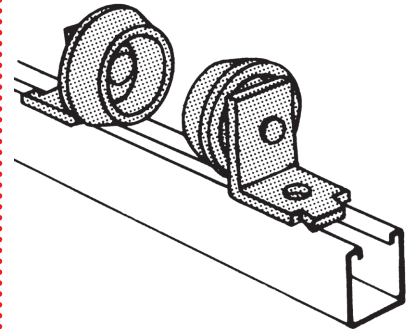

Cast aluminum rollers, steel brackets. Designed for standard saddles. Order separately for each pair of rollers: two 1/2 in. x 5/16 in. hex head cap screws and two 1/2 in. channel nuts. Space to suit O.D. of pipe and wrapping.

Design Load: 2350 lb.

Wt./C : 300 lb.

Adjustable Universal Support

Support building services and access equipment on flat roofs and flat surfaces



The T&B Adjustable Universal Support (AUS) provides an easy method for supporting pipes, conduit and equipment on flat roofs, below raised floors and even on level ground applications. The AUS reduces installation time compared to other support solutions such as wooden blocks, cement blocks, straps and clips. These labor intensive solutions also increase the danger of roof membrane penetration.

The AUS system also allows for tool free adjustment of the pedestal height from 6 to 9 inches with a twist of the wrist. This ensures that the supported objects or pipes are uniformly supported and no high stress supports are carrying a disproportionate load in a single location.

Cat. No.	Description	Qty.
AUS14-96	Adjustable Universal Support (Base only)	1
AUS-RISER-KIT	Riser Kit	
A1200HS100PG	14 in. strut	1
H104-1/2X10EGC	12 in. threaded rod	2
E145-1/2EGC	Nut	8
E147-1/2EGC	Washer	8
E148-1/2EGC	Lock washer	4
AUS-STRUT-KIT	Bolt Kit	
A1200HS100PG	14 in. strut	1
E142-1/2X200EGC	Bolt	2
E145-1/2EGC	Nut	2
E147-1/2EGC	Washer	4
E148-1/2EGC	Lock washer	2
AUS125PCSS6	4-1/2 in. stainless steel 316 strap (to restrain 1-1/4 in. pipe)	2
AUS150PCSS6	5 in. strap (to restrain 1-1/2 in. pipe)	2
AUS200PCSS6	6 in. strap (to restrain 2 in. pipe)	2

