



SIEMENS
Ingenuity for life

30A ID Series
Product
Specification
Sheet

ID Switches

3 Pole, 30 Amp, Type 1 (Indoor)

Features

- Designed for the Canadian construction market
- Suitable for use in a circuit that is rated for 200kA RMS – symmetrical and 600V maximum
- Continuous load 80% of fuse rating except for motor circuits
- CSA Certified under file #13076
- Compact size with integrated handle
- Type 1 enclosure for indoor applications
- Quick make-quick break mechanism
- Padlock-off handle feature
- Door padlock provision
- Use C.S.A certified, H.R.C. fuses. Form I (Class J, R or H) and Form II fuses if the accepted adaptor kits are provided
- Fuse puller included
- Manufactured in Canada for quick delivery and easy access to replacement parts

General information*

Part number	Max. Voltage	Description	Unit weight – lbs (kg)
ID321	240V AC	3 Pole, 3 Wire, Fusible	12.61 (5.72)
ID361	600V AC	3 Pole, 3 Wire, Fusible	12.61 (5.72)
ID361NF	600V AC	3 Pole, 3 Wire, Non-Fusible	12.18 (5.52)

* Not suitable for direct current systems

Maximum horsepower ratings

	1-PH	3-PH
240V AC Max HP†	3	7.5
480V AC Max HP†	—	15
600V AC Max HP†	10	20

† At maximum HP rating, time delay type fuses may be required for starting purpose

Accessories

RFAK21	Type R fuse kit 240V (Order one per pole)
RFAK61	Type R fuse kit 600V (Order one per pole)
MSSAK116	Auxiliary contact kit, 1 NO + 1 NC (30–100A)
MSSAK216	Auxiliary contact kit, 2 NO + 2 NC (30–100A)
FP2	Fuse puller kit (Order one per 3-pole switch)
N60	Neutral kit (Order one per 3-pole switch)
CCSS1	Replacement cover catch kit (20 pieces per kit)
LSK1	Replacement line shield kit (three pieces per kit)

Lug size data

Amp rating	Lugs/Pole	Wire range; Copper or Aluminium	
		Line and load	Neutral
30	1	#14 -2 AWG	#14 -4 AWG

Dimension drawings – units: inches [mm]

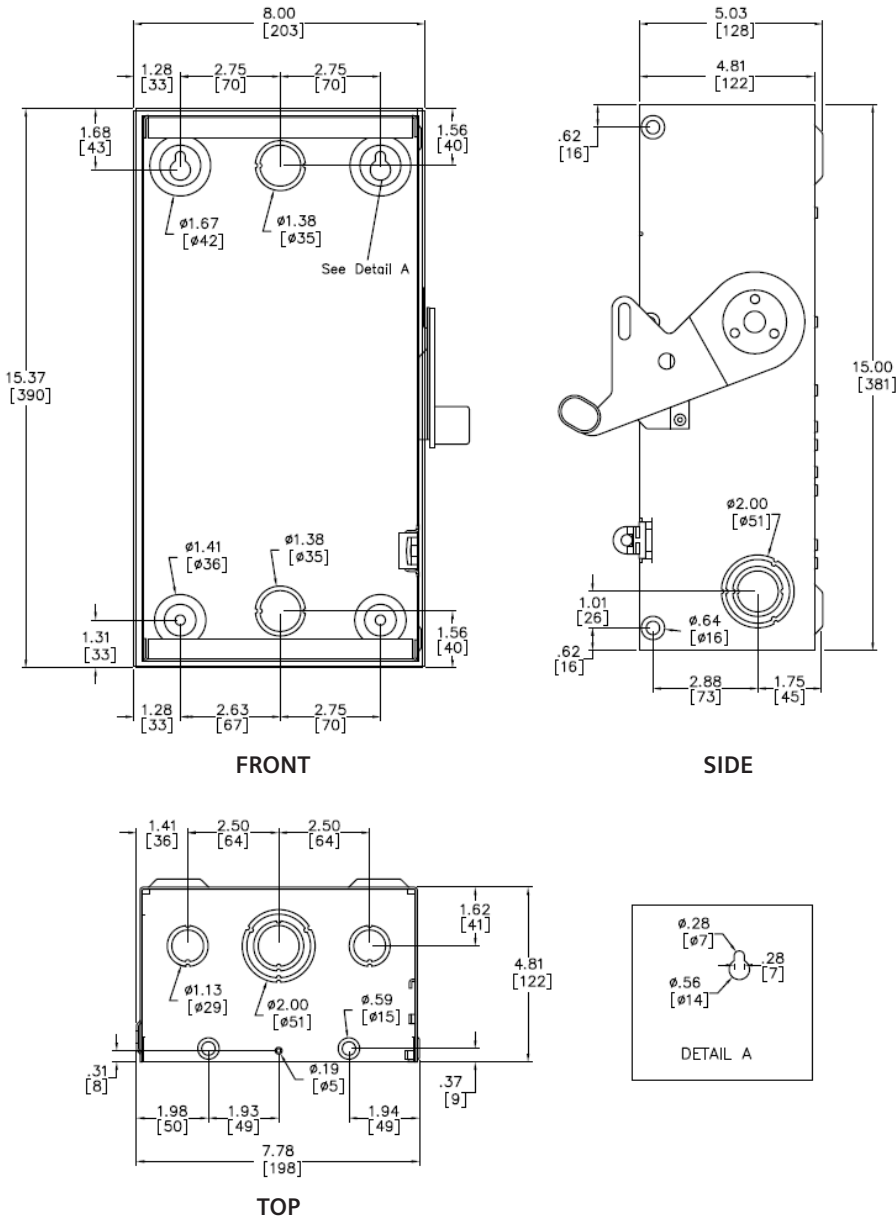

Knock-out diagram

30 Amp Enclosure, Type ID

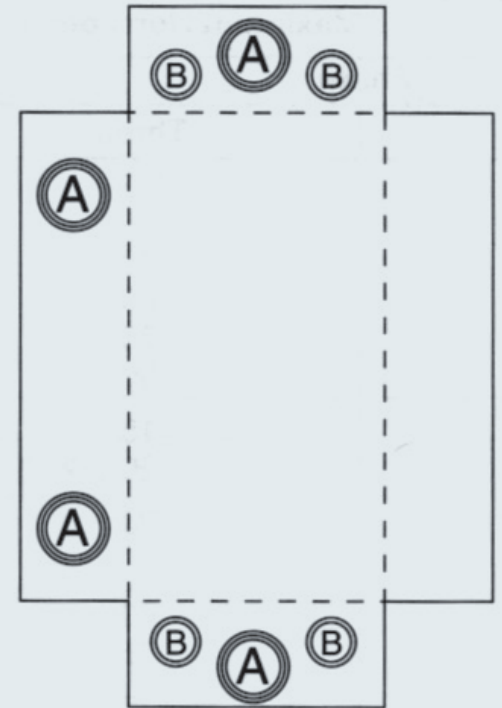

K.O.'s trade size

A = 3/4", 1", 1 1/4", 1 1/2"

B = 1/2", 3/4"

Wiring diagrams

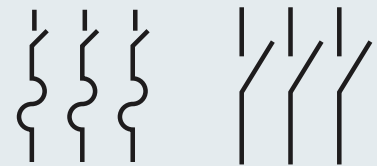

ID321 / ID361

ID361NF

Siemens Canada Limited
 Energy Management Division
 Low Voltage & Products
 1577 North Service Road East
 Oakville, ON L6H 0H6

Customer Interaction Centre
 (888) 303-3353
 cic.ca@siemens.com

Subject to change without prior notice.
 Printed in Canada.
 © 2018 Siemens Canada Limited
 Order No: EM-LP-1513

The information provided in this flyer contains merely general descriptions or characteristics of performance which in case of actual use do not always apply as described or which may change as a result of further development of the products. An obligation to provide the respective characteristics shall only exist if expressly agreed in the terms of contract.

All product designations may be trademarks or product names of Siemens AG or supplier companies whose use by third parties for their own purposes could violate the rights of the owners.



SIEMENS
Ingenuity for life

60A ID Series
Product
Specification
Sheet

ID Switches

3 Pole, 60 Amp, Type 1 (Indoor)

Features

- Designed for the Canadian construction market
- Suitable for use in a circuit that is rated for 200kA RMS – symmetrical and 600V maximum
- Continuous load 80% of fuse rating except for motor circuits
- CSA Certified under file #13076
- Compact size with integrated handle
- Type 1 enclosure for indoor applications
- Quick make-quick break mechanism
- Padlock-off handle feature
- Door padlock provision
- Use C.S.A certified, H.R.C. fuses. Form I (Class J, R or H) and Form II fuses if the accepted adaptor kits are provided
- Fuse puller included
- Manufactured in Canada for quick delivery and easy access to replacement parts

General information*

Part number	Max. voltage	Description	Unit weight – lbs (kg)
ID322	240V AC	3 Pole, 3 Wire, Fusible	12.61 (5.72)
ID362	600V AC	3 Pole, 3 Wire, Fusible	12.61 (5.72)
ID362NF	600V AC	3 Pole, 3 Wire, Non-Fusible	12.18 (5.52)

* Not suitable for direct current systems

Maximum horsepower ratings

	1-PH	3-PH
240V AC Max HP†	10	15
480V AC Max HP†	—	30
600V AC Max HP†	25	50

† At maximum HP rating, time delay type fuses may be required for starting purpose

Accessories

RFAK22	Type R fuse kit 240V (Order one per pole)
RFAK62	Type R fuse kit 600V (Order one per pole)
MSSAK116	Auxiliary contact kit, 1 NO + 1 NC (30–100A)
MSSAK216	Auxiliary contact kit, 2 NO + 2 NC (30–100A)
FP2	Fuse puller kit (Order one per 3-pole switch)
N60	Neutral kit (Order one per 3-pole switch)
CCSS1	Replacement cover catch kit (20 pieces per kit)
LSK1	Replacement line shield kit (three pieces per kit)

Lug Size Data

Amp rating	Lugs/Pole	Wire range; Copper or Aluminium	
		Line and load	Neutral
60	1	#14 -2 AWG	#14 -4 AWG

Dimension drawings – units: inches [mm]

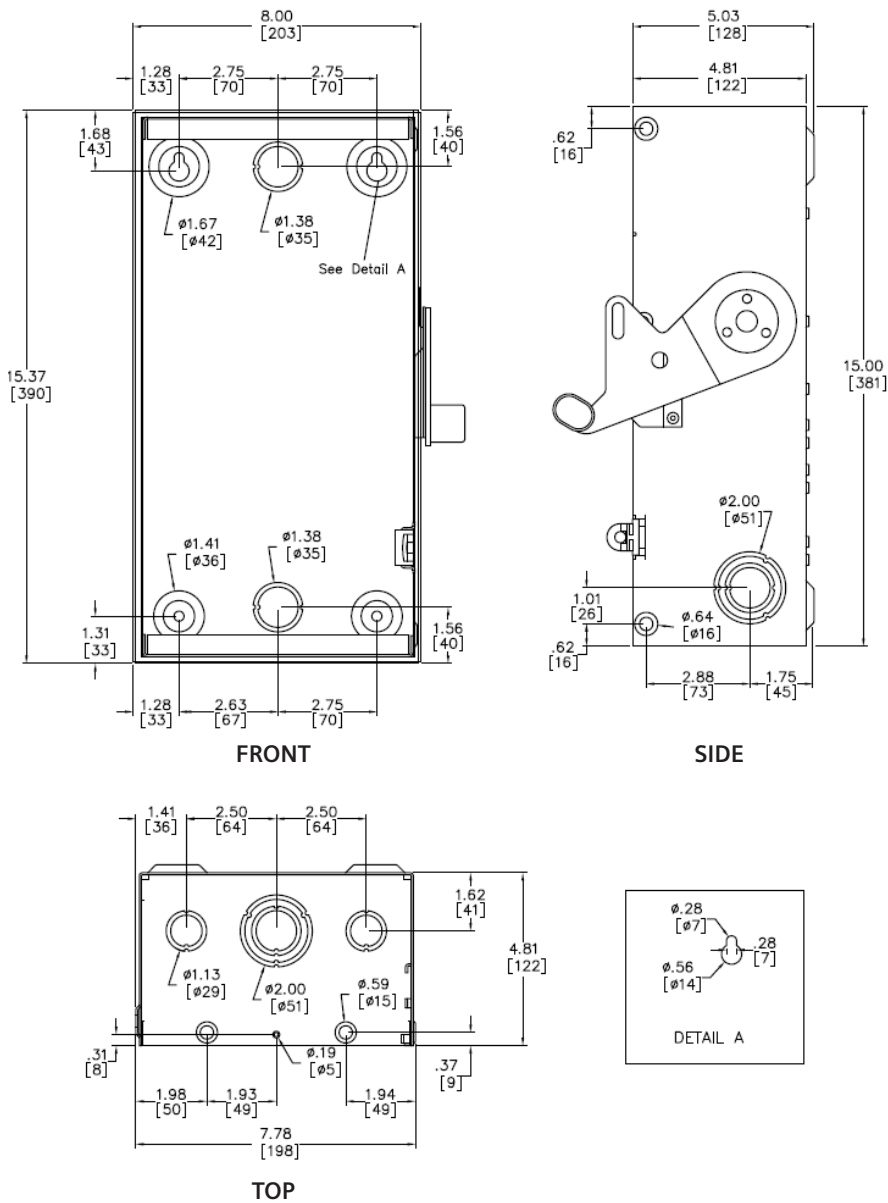

Knock-out diagram

30–60 Amp Enclosure, Type ID

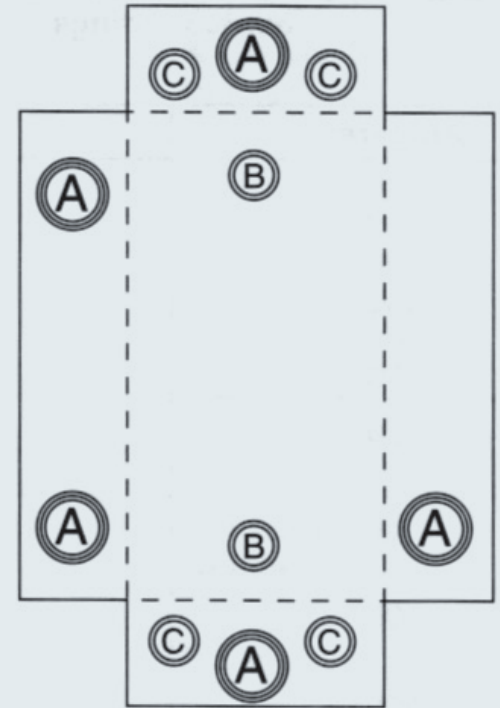

K.O.'s trade size

A = 3/4", 1", 1 1/4", 1 1/2"

B = 3/4", 1"

C = 1/2", 3/4"

Wiring diagrams

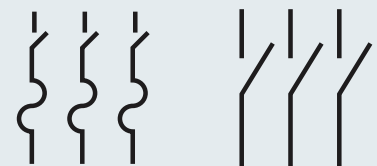

ID322 / ID362

ID362NF

Siemens Canada Limited
Energy Management Division
Low Voltage & Products
1577 North Service Road East
Oakville, ON L6H 0H6

Customer Interaction Centre
(888) 303-3353
cic.ca@siemens.com

Subject to change without prior notice.
Printed in Canada.
© 2018 Siemens Canada Limited
Order No: EM-LP-1515

The information provided in this flyer contains merely general descriptions or characteristics of performance which in case of actual use do not always apply as described or which may change as a result of further development of the products. An obligation to provide the respective characteristics shall only exist if expressly agreed in the terms of contract.

All product designations may be trademarks or product names of Siemens AG or supplier companies whose use by third parties for their own purposes could violate the rights of the owners.

ID Switches

3 Pole, 100 Amp, Type 1 (Indoor)

Features

- Designed for the Canadian construction market
- Suitable for use in a circuit that is rated for 200kA RMS – symmetrical and 600V maximum
- Continuous load 80% of fuse rating except for motor circuits
- CSA Certified under file #13076
- Compact size with integrated handle
- Type 1 enclosure for indoor applications
- Quick make-quick break mechanism
- Padlock-off handle feature
- Door padlock provision
- Fuse puller included
- Use C.S.A certified, H.R.C. fuses. Form I (Class J, R or H) and Form II fuses if the accepted adaptor kits are provided
- Manufactured in Canada for quick delivery and easy access to replacement parts

General information*

Part number	Max. voltage	Description	Unit weight – lbs (kg)
ID323	240V AC	3 Pole, 3 Wire, Fusible	17.22 (7.81)
ID363	600V AC	3 Pole, 3 Wire, Fusible	17.22 (7.81)
ID363NF	600V AC	3 Pole, 3 Wire, Non-Fusible	16.58 (7.52)

* Not suitable for direct current systems

Maximum horsepower ratings

	1-PH	3-PH
240V AC Max HP†	15	30
480V AC Max HP†	—	60
600V AC Max HP†	40	75

† At maximum HP rating, time delay type fuses may be required for starting purpose

Accessories

RFAK3	Type R fuse kit (Order one per pole)
TFAK23	Type T fuse kit 240V (Order one per pole)
MSSAK116	Auxiliary contact kit, 1 NO + 1 NC (30–100A)
MSSAK216	Auxiliary contact kit, 2 NO + 2 NC (30–100A)
FP3	Fuse puller (Order one per 3-pole switch)
N100	Neutral kit (Order one per 3-pole switch)
CCSS1	Replacement cover catch kit (20 pieces per kit)
LSK 4	Replacement line shield kit (three pieces per kit)

Lug size data

Amp rating	Lugs/Pole	Wire range; Copper or Aluminium	
		Line and load	Neutral
100	1	Line: #6 - 250 MCM Load: #14 - 1/0 AWG	#14 - 2/0 AWG

Dimension drawings – units: inches [mm]

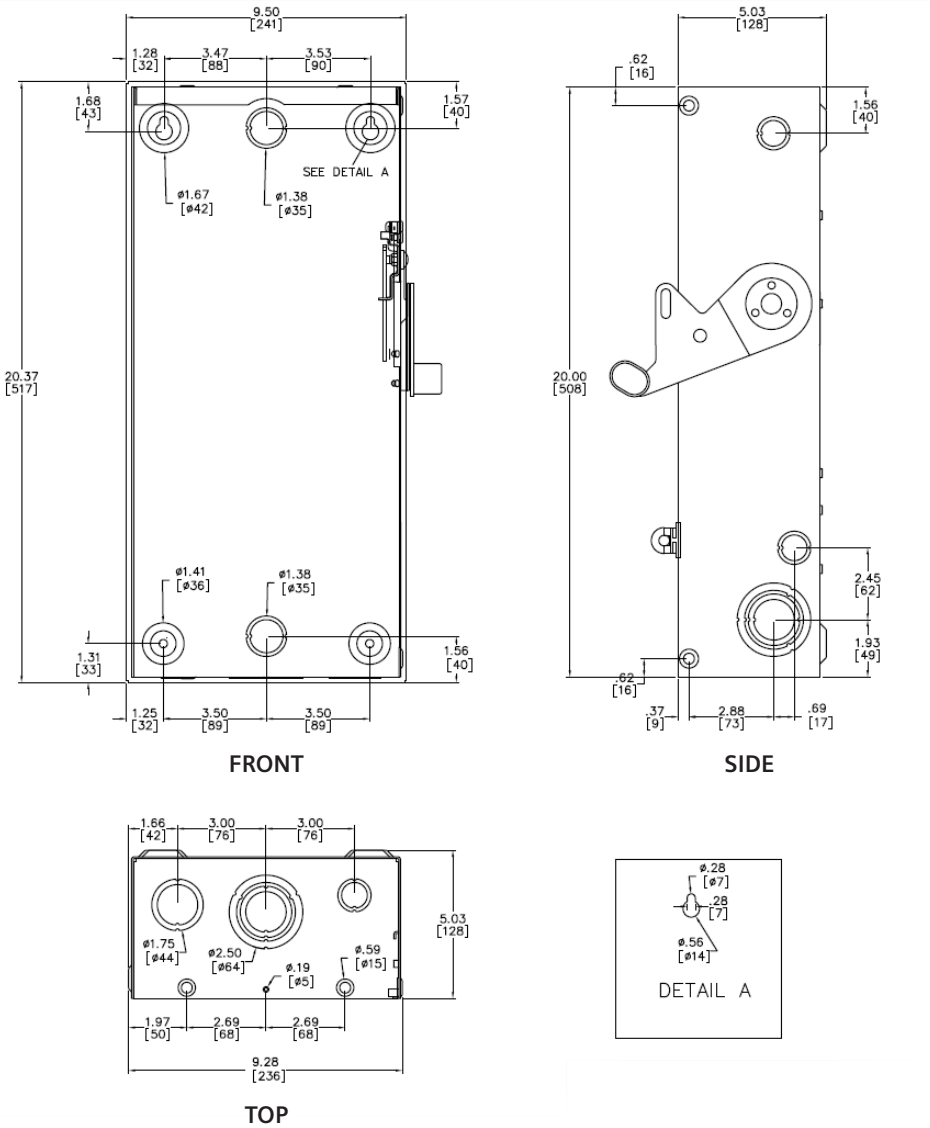

Knock-out diagram

100 Amp Enclosure, Type ID

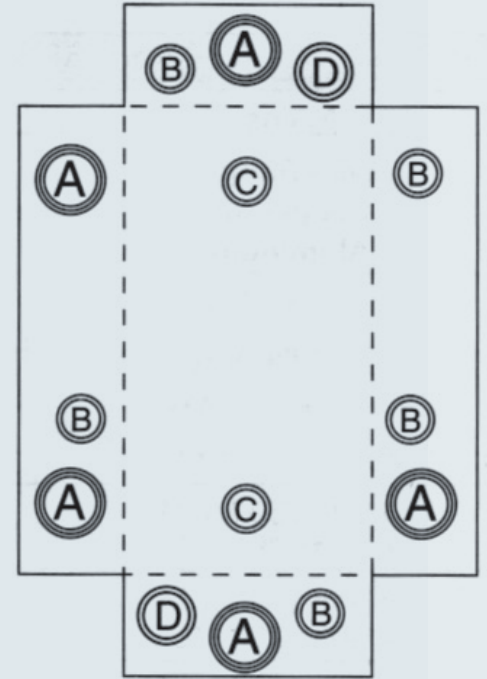

K.O.'s trade size

- A = 1", 1 1/4", 1 1/2", 2"
- B = 1/2", 3/4"
- C = 3/4", 1"
- D = 1", 1 1/4"

Wiring diagrams

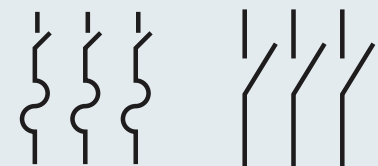

ID323 / ID363

ID363NF

Siemens Canada Limited
 Energy Management Division
 Low Voltage & Products
 1577 North Service Road East
 Oakville, ON L6H 0H6

Customer Interaction Centre
 (888) 303-3353
 cic.ca@siemens.com

Subject to change without prior notice.
 Printed in Canada.
 © 2018 Siemens Canada Limited
 Order No: EM-LP-1517

The information provided in this flyer contains merely general descriptions or characteristics of performance which in case of actual use do not always apply as described or which may change as a result of further development of the products. An obligation to provide the respective characteristics shall only exist if expressly agreed in the terms of contract.

All product designations may be trademarks or product names of Siemens AG or supplier companies whose use by third parties for their own purposes could violate the rights of the owners.

ID Switches

3 Pole, 200 Amp, Type 1 (Indoor)

Features

- Designed for the Canadian construction market
- Suitable for use in a circuit that is rated for 200kA RMS – symmetrical and 600V maximum
- Continuous load 80% of fuse rating except for motor circuits
- CSA Certified under file #13076
- Compact size with integrated handle
- Type 1 enclosure for indoor applications
- Quick make-quick break mechanism
- Padlock-off handle feature
- Fuse puller included
- Door padlock provision
- Use C.S.A certified, H.R.C. fuses. Form I (Class J, R or H) and Form II fuses if the accepted adaptor kits are provided
- Manufactured in Canada for quick delivery and easy access to replacement parts

General information*

Part number	Max. voltage	Description	Unit weight – lbs (kg)
ID324	240V AC	3 Pole, 3 Wire, Fusible	31.52 (14.3)
ID364	600V AC	3 Pole, 3 Wire, Fusible	31.52 (14.3)
ID364NF	600V AC	3 Pole, 3 Wire, Non-Fusible	29.64 (13.44)

* Not suitable for direct current systems

Maximum horsepower ratings

	1-PH	3-PH
240V AC Max HP†	15	60
480V AC Max HP†	—	125
600V AC Max HP†	50	150

† At maximum HP rating, time delay type fuses may be required for starting purpose

Accessories

RFAK4	Type R fuse kit (Order one per pole)
TFAK24	Type T fuse kit 240V (Order one per pole)
TFAK64	Type T fuse kit 600V (Order one per pole)
MSSAK126	Auxiliary contact kit, 1 NO + 1 NC (30–100A)
MSSAK226	Auxiliary contact kit, 2 NO + 2 NC (30–100A)
FP4	Fuse puller (Order one per 3-pole switch)
N200	Neutral kit (Order one per 3-pole switch)
CCSS1	Replacement cover catch kit (20 pieces per kit)
LSK4	Replacement line shield kit (three pieces per kit)

Lug size data

Amp rating	Lugs/Pole	Wire range; Copper or Aluminium	
		Line and load	Neutral
200	1	#6 - 250 MCM	#6 - 300 MCM

Dimension drawings – units: inches [mm]

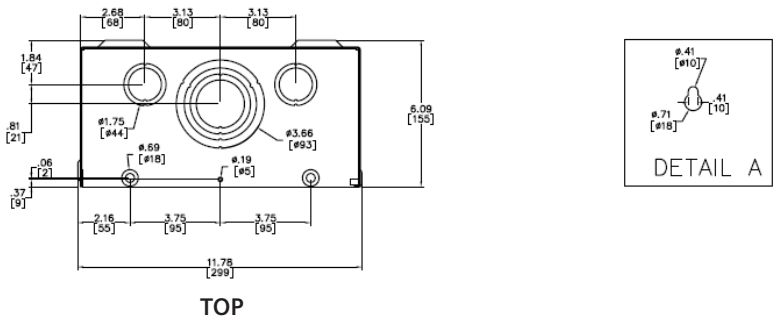
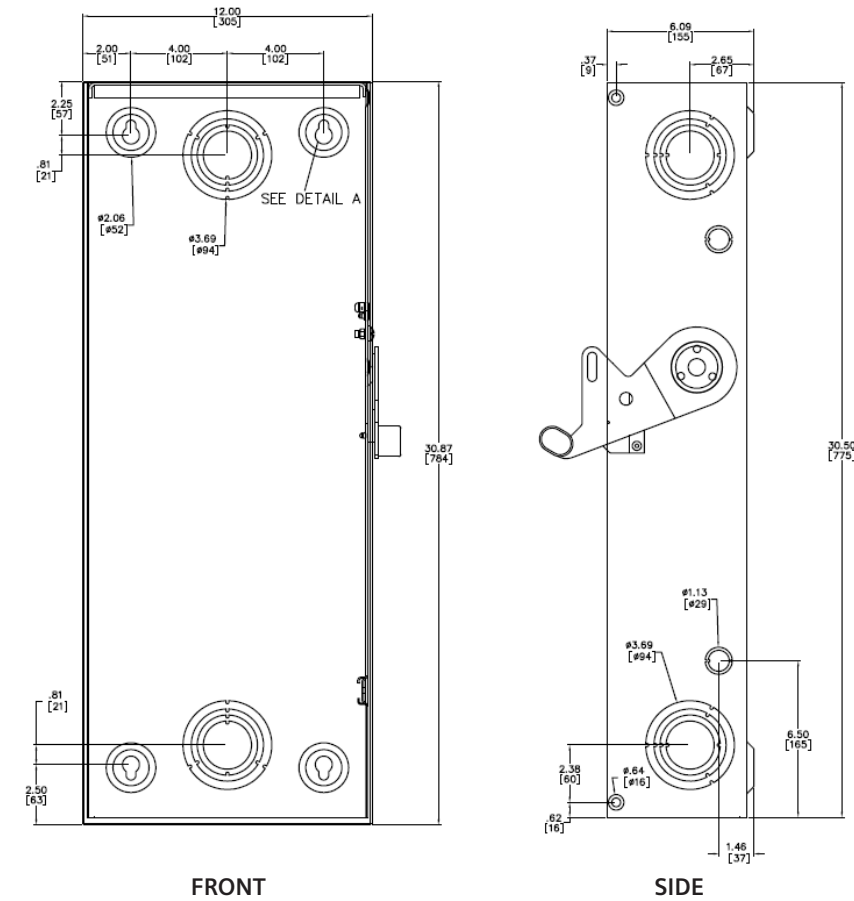

Knock-out diagram

200 Amp Enclosure, Type ID

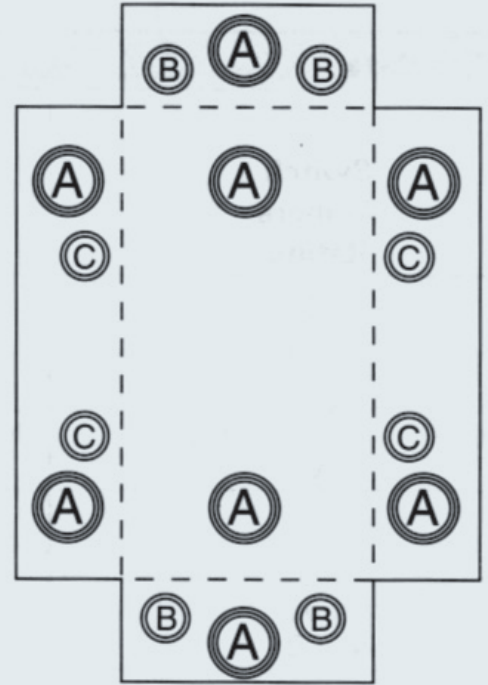

K.O.'s trade size

- A = 1½", 2", 2½", 3"
- B = 1", 1¼"
- C = ½", ¾"

Wiring diagrams

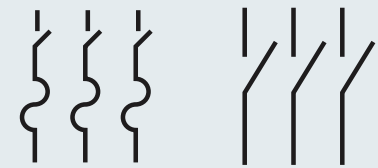

ID324 / ID364

ID364NF

Siemens Canada Limited
 Energy Management Division
 Low Voltage & Products
 1577 North Service Road East
 Oakville, ON L6H 0H6

Customer Interaction Centre
 (888) 303-3353
 cic.ca@siemens.com

Subject to change without prior notice.
 Printed in Canada.
 © 2018 Siemens Canada Limited
 Order No: EM-LP-1519

The information provided in this flyer contains merely general descriptions or characteristics of performance which in case of actual use do not always apply as described or which may change as a result of further development of the products. An obligation to provide the respective characteristics shall only exist if expressly agreed in the terms of contract.

All product designations may be trademarks or product names of Siemens AG or supplier companies whose use by third parties for their own purposes could violate the rights of the owners.



SIEMENS
Ingenuity for life

400A ID Series
Product
Specification
Sheet

ID Switches

3 Pole, 400 Amp, Type 1 (Indoor)

Features

- Designed for the Canadian construction market
- Suitable for use in circuits rated for 100kA RMS – symmetrical and 600V maximum
- Continuous load 80% of fuse rating except for motor circuits
- CSA Certified under file #13076
- Compact size with integrated handle
- Type 1 enclosure for indoor applications
- Quick make-quick break mechanism
- Padlock-off handle feature
- Door padlock provision
- Knock out removed for increased installation flexibility
- Use C.S.A certified, H.R.C. fuses. Form I (Class J, R or H) and Form II fuses if the accepted adaptor kits are provided
- Manufactured in Canada for quick delivery and easy access to replacement parts

General information*

Part number	Max. voltage	Description	Unit weight – lbs (kg)
ID225	240V AC	2 Pole, 3 Wire, Fusible with neutral	76 (34.47)
ID425	240V AC	3 Pole, 4 Wire, Fusible with neutral	89 (40.36)
ID365	600V AC	3 Pole, 3 Wire, Fusible	88 (39.62)
ID365NF	600V AC	3 Pole, 3 Wire, Non-Fusible	87 (39.46)

* Not suitable for direct current systems

Maximum horsepower ratings

	1-PH	3-PH
240V AC Max HP†	—	125
480V AC Max HP†	—	250
600V AC Max HP†	—	250

† At maximum HP rating, time delay type fuses may be required for starting purpose

Accessories

RFAK6	Type R fuse kit (Order one per pole)
N400ID	Neutral kit (Order one per 3-pole switch)
TFAK52	Type T fuse kit 240V (Order one per pole)
TFAK55	Type T fuse kit 600V (Order one per pole)
CLOBK5	Replacement load base kit
CLIBK5	Replacement line base kit

Lug size data

Amp rating	Lugs/Pole	Wire range; Copper or Aluminium	
		Line and load	Neutral
400	1	(1)1/0 to 750 MCM or (2)1/0 to 250 MCM	

Dimension drawings – units: inches [mm]

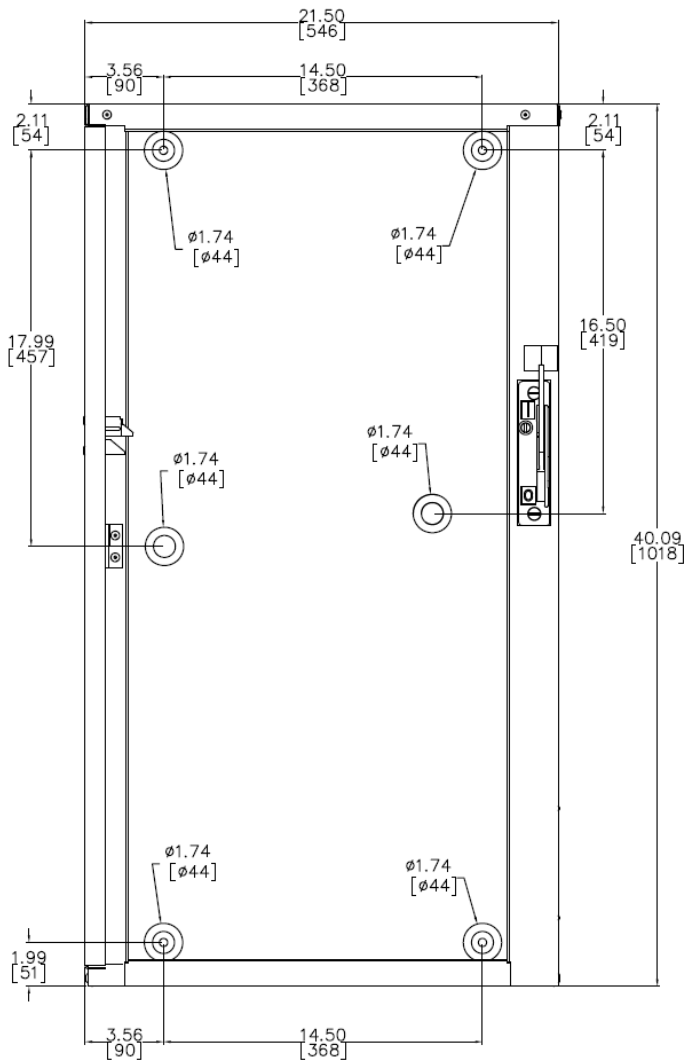

FRONT

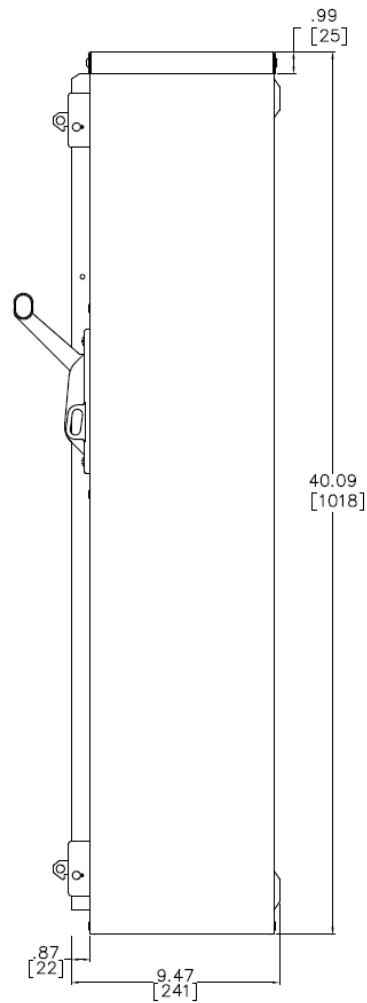

SIDE

Wiring diagrams

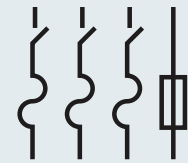

ID425

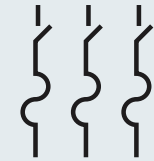

ID365

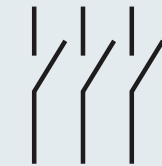

ID365NF

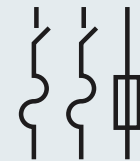

ID225

Siemens Canada Limited
Energy Management Division
Low Voltage & Products
1577 North Service Road East
Oakville, ON L6H 0H6

Customer Interaction Centre
(888) 303-3353
cic.ca@siemens.com

Subject to change without prior notice.
Printed in Canada.
© 2018 Siemens Canada Limited
Order No: EM-LP-1521

The information provided in this flyer contains merely general descriptions or characteristics of performance which in case of actual use do not always apply as described or which may change as a result of further development of the products. An obligation to provide the respective characteristics shall only exist if expressly agreed in the terms of contract.

All product designations may be trademarks or product names of Siemens AG or supplier companies whose use by third parties for their own purposes could violate the rights of the owners.

ID Switches

3 Pole, 600 Amp, Type 1 (Indoor)

Features

- Designed for the Canadian construction market
- Suitable for use in circuits rated for 100kA RMS – symmetrical and 600V maximum
- Continuous load 80% of fuse rating except for motor circuits
- CSA Certified under file #13076
- Compact size with integrated handle
- Type 1 enclosure for indoor applications
- Quick make-quick break mechanism
- Padlock-off handle feature
- Door padlock provision
- Knock out removed for increased installation flexibility
- Use C.S.A. certified fuses H.R.C. Form I (Class J, R, T or H) and Form II Class C fuses if the accepted adaptor kits are provided
- Manufactured in Canada for quick delivery and easy access to replacement parts

General information*

Part number	Max. voltage	Description	Unit weight – lbs (kg)
ID226	240V AC	2 Pole, 3 Wire, Fusible with neutral	102 (46.27)
ID426	240V AC	3 Pole, 4 Wire, Fusible with neutral	102 (46.27)
ID366	600V AC	3 Pole, 3 Wire, Fusible	101 (45.81)
ID366NF	600V AC	3 Pole, 3 Wire, Non-Fusible	97 (44)

* Not suitable for direct current systems

Maximum horsepower ratings

	1-PH	3-PH
240V AC Max HP†	—	200
480V AC Max HP†	—	400
600V AC Max HP†	—	500

† At maximum HP rating, time delay type fuses may be required for starting purpose

Accessories

RFAK6N	Type R fuse kit (Order one per pole)
N600ID	Neutral kit (Order one per 3-pole switch)
TFAK62	Type T fuse kit 240V (Order one per pole)
TFAK65	Type T fuse kit 600V (Order one per pole)
CLOBK6	Replacement load base kit
CLIBK6	Replacement line base kit

Lug size data

Amp rating	Lugs/Pole	Wire range; Copper or Aluminium	
		Line and load	Neutral
600	2	(1)1/0 to 750 MCM or (2)1/0 to 250 MCM	

Dimension drawings – units: inches [mm]

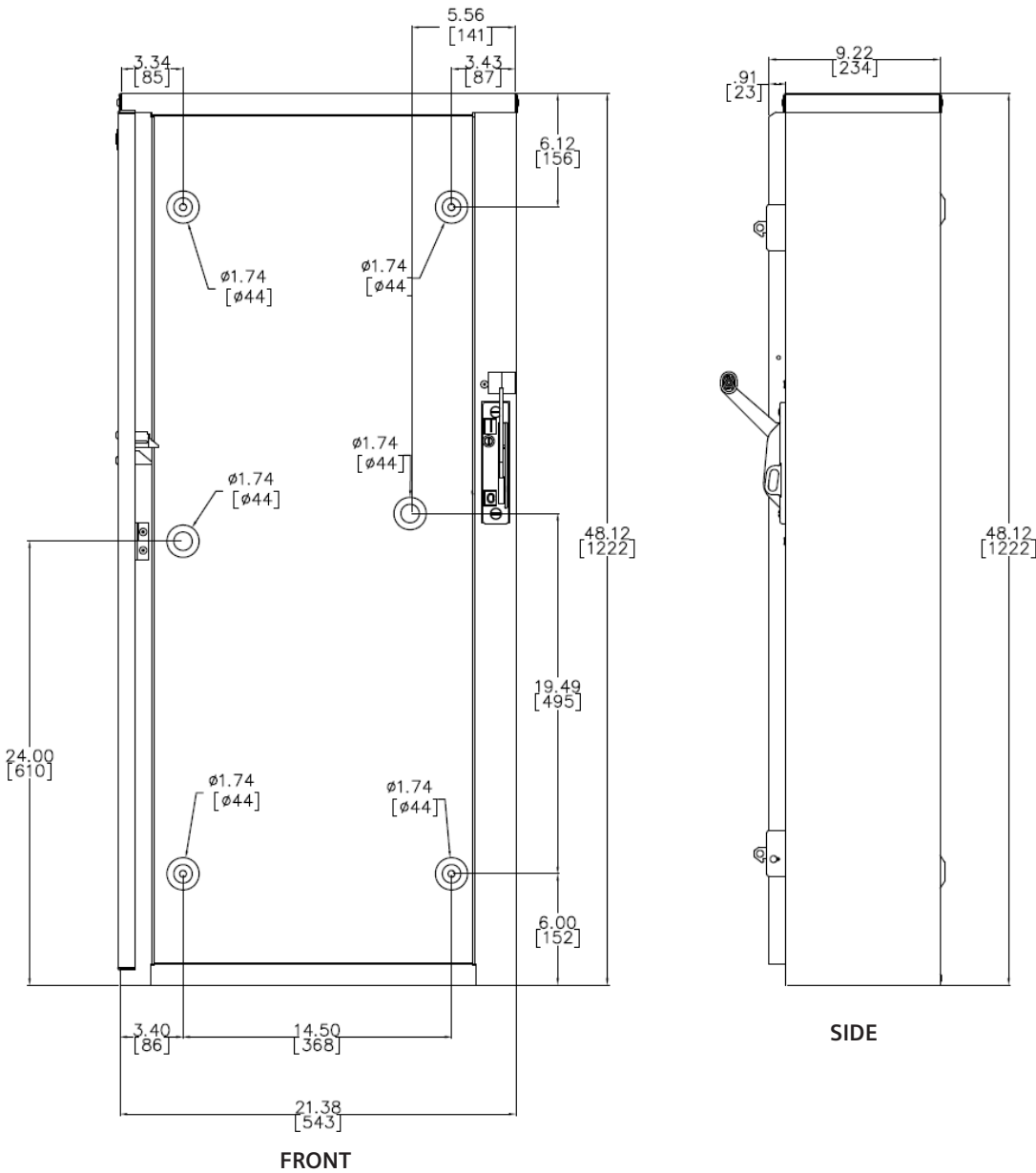

Wiring diagrams

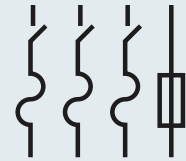

ID426

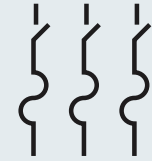

ID366

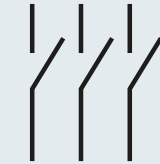

ID366NF

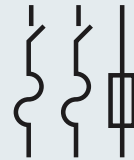

ID226

Siemens Canada Limited
 Energy Management Division
 Low Voltage & Products
 1577 North Service Road East
 Oakville, ON L6H 0H6

Customer Interaction Centre
 (888) 303-3353
 cic.ca@siemens.com

Subject to change without prior notice.
 Printed in Canada.
 © 2018 Siemens Canada Limited
 Order No: EM-LP-1523

The information provided in this flyer contains merely general descriptions or characteristics of performance which in case of actual use do not always apply as described or which may change as a result of further development of the products. An obligation to provide the respective characteristics shall only exist if expressly agreed in the terms of contract.

All product designations may be trademarks or product names of Siemens AG or supplier companies whose use by third parties for their own purposes could violate the rights of the owners.