

# ON-Q

## STRUCTURED WIRING & CONNECTIVITY GUIDE

Structured Wiring, Connectivity &  
Home Theater Solutions



designed to be better.™

 **legrand**®

# SUPERIOR INFRASTRUCTURE SOLUTIONS



As the industry leader in structured wiring, Legrand provides the proven, practical solutions preferred by installers and major home builders across the country. Our comprehensive On-Q product offering — which includes wall plates, jacks, HDMI cables, straps, tools, modules, enclosures & home theater solutions — simplifies installations and reduces time on site. We specialize in meeting the right specifications for any project — residential or light commercial — with solutions that exceed your needs. From single-family homes to apartments, townhomes to condominiums, Legrand has the professional answer for any project.



# TABLE OF CONTENTS

ENCLOSURES .....	4	HOME THEATER SOLUTIONS.....	18
PLASTIC ENCLOSURES .....	4	HOME THEATER WALL PLATES & STRAPS .....	18
METAL ENCLOSURES .....	5	CABLE ACCESS WALL PLATES .....	18
ACCESSORIES.....	6	HOME THEATER CONNECTIONS.....	19
PLASTIC MDUS.....	7	IN-WALL TV POWER KITS .....	20
VIDEO & VOICE DISTRIBUTION .....	8	HOME THEATER ACCESSORIES.....	20
VOICE & VIDEO MODULES .....	8	AV CABLING .....	21
HOME NETWORKING .....	9	HDMI CABLES.....	21
NETWORK MODULES .....	9	AUDIO/VIDEO CABLES .....	23
POWER MANAGEMENT .....	10	PATCH CABLES .....	24
POWER SUPPLIES.....	10	CABLE TIES & PATCH PANELS .....	25
POWER MODULES.....	10	CABLE TIES.....	25
DATA CONNECTIVITY.....	11	PATCH PANELS .....	25
LOW VOLTAGE BRACKETS .....	11	INSTALLATION TOOLS & CONNECTORS.....	26
KEystone WALL PLATES .....	14	TOOLS.....	26
WALL PLATES .....	15	CONNECTORS.....	26
STRAPS.....	16	RESOURCES & SUPPORT .....	27
SURFACE MOUNT BOXES.....	16		
PRE-MOLDED WALL PLATES & STRAPS .....	17		
PRE-CONFIGURED PLATES & STRAPS .....	17		

# ENCLOSURES

## PLASTIC ENCLOSURES

- Enclosure trim ring comes free, essential for concealing drywall cutouts for a professional look
- Universal mounting grid maximizes compatibility with third party products without additional brackets
- Extra venting along vertical plane of door allows for superior heat dissipation
- Reversible door snaps easily into trim ring without tools, swings a full 180 degrees
- Lockable with included screws or Optional Keyed Lock (364487-01)
- UL listed and USA-Made

DESCRIPTION	20" Enclosure	30" Enclosure	42" Enclosure
			

Enclosure Dimensions	22.2 L x 17.5 W x 5.5 D	32.2 L x 17.5 W x 5.5 D	44.2 L x 17.5 W x 5.5 D
Plastic Enclosure with Hinged Door & Trim Ring	ENP2050-NA	ENP3050-NA	ENP4250-NA
Plastic Hinged Door & Trim Ring Only	ENP2060-NA	ENP3060-NA	ENP4260-NA
Plastic Enclosure Only	ENP2080-NA	ENP3080-NA	ENP4280-NA
Plastic Hinged Door & Trim Ring Only (Pack of 5)	ENP20605-NA	ENP30605-NA	ENP42605-NA
Plastic Enclosure Only (Pack of 5)	ENP20805-NA	ENP30805-NA	ENP42805-NA
Trim Ring, For Replacement Only	ENP2001-NA	ENP3001-NA	ENP4201-NA

## ACCESSORIES

364487-01	Replacement Lock Assembly & 2 Key Kit
AC1034	2" Rubber Grommet Pack for Plastic Enclosure (Pack of 5)
AC1035-20	Cable Management Clips (20)
AC1040	Plastic Universal Mounting Plate
AC1041	Fiber Management Spools (pair)





Accessories compatible with plastic enclosures only



# ENCLOSURES

## METAL ENCLOSURES

- Flush and surface installation options
- Flanged covers hide drywall openings
- UL listed for fire and security alarm equipment
- Made in the USA
- Cable guard insert protects cables and equipment from dust, paint and debris between rough-in and trim out
- Includes 3 powder-coated openings for cable pass-through

DESCRIPTION	12" Enclosure	14" Enclosure	20" Enclosure	28" Enclosure	42" Enclosure
					

Enclosure Dimensions	12.13" H x 14.25" W x 3.6" D	14" H x 14.25" W x 3.6" D	20" H x 14.25" W x 3.6" D	28" H x 14.25" W x 3.6" D	42" H x 14.25" W x 3.6" D
Enclosure with Screw-On Cover	EN1200	EN1400	EN2000	EN2800	EN4200
Enclosure with Hinged Cover	N/A	EN1450	EN2050	EN2850	EN4250
Enclosure, Only	N/A	EN1480	EN2080	EN2880	EN4280
Screw On Cover, Only	EN1220	EN1420	EN2020	EN2820	EN4220
Hinged Cover, Only	N/A	EN1460	EN2060	EN2860	EN4260
Enclosure Only, with Stackable Knockouts*	N/A	EN1485	EN2085	EN2885	EN4285
Enclosure Depth Extender**	N/A	N/A	N/A	364450-03	364450-04
Enclosure Extender Wire Manager	N/A	N/A	N/A	364482-01	364482-01
Brushed Aluminum Frame, Clear Insert (Cover Only)	N/A	N/A	N/A	364593-11	364594-11
Brushed Aluminum Frame, Smoke Insert (Cover Only)	N/A	N/A	N/A	364593-14	364594-14

\* This enclosure has five knockout locations and allows vertical alignment of two enclosures for cable pass-through.

\*\* Extenders add 2.5" of enclosure depth.

# ENCLOSURES

## ACCESSORIES



364254-01



364259-01



364465-01



364466-01



364478-01



364714-08



364715-01



F7510



F9001



364896-01



364904-01



AC1011



AC1020



364264-01



364265-01



AC1040



AC1041



AC1042



363729-01



364490-01



AC1017



F2242



F2249

## PLASTIC & METAL ENCLOSURE ACCESSORIES

PART NO.	DESCRIPTION
364254-01	Cable Modem Mounting Plate
364259-01	Caddx Mounting Plate
364465-01	DSC 1555 Mounting Plate, Half Width
364466-01	DSC 832/1555 Mounting Plate, Full Width
364478-01	Replacement Lock Assembly & 2 Key Kit
364516-01	Caddx NetworX Series Mounting Plate - not shown
364714-08	Ademco Half Width Controller Mounting Plate
364715-01	Ademco Universal Controller Mounting Plate
364819-01	Two Bay Bracket
F7510	Three Bay Bracket
F9001	Six Bay Bracket
364896-01	Universal Mounting Plate, Half Width
364904-01	Universal Mounting Plate, Full Width
AC1011	Universal Circuit Board Mounting Bracket
AC1020	Third-Party Enclosure Mounting Bracket
364264-01	Battery Holder, Half-Width
364265-01	Battery Holder, Full-Width
AC1040	Plastic Universal Mounting Plate
AC1041	Fiber Management Spools (pair)
AC1042	MDU Mounting Bracket

## METAL-ONLY ACCESSORIES

PART NO.	DESCRIPTION
363729-01	Plungers & Grommets (10 Pack)
364490-01	Replacement Key & Cover Hardware Kit
AC1017	2 Conduit Mounting Plate
AC1019	Latch Lock Kit, Hinged Cover - not shown
F2242	2.5" Grommet Ring
F2249	2.5" Knockout Plug

# ENCLOSURES

## PLASTIC MDU

- Knockouts include screw driver holes for easy removal
- Includes four self-tapping screws for mounting and optional hardware to lock the cover
- Multiple compatible video, voice, and data distribution modules available
- Flush and surface-mount installation options

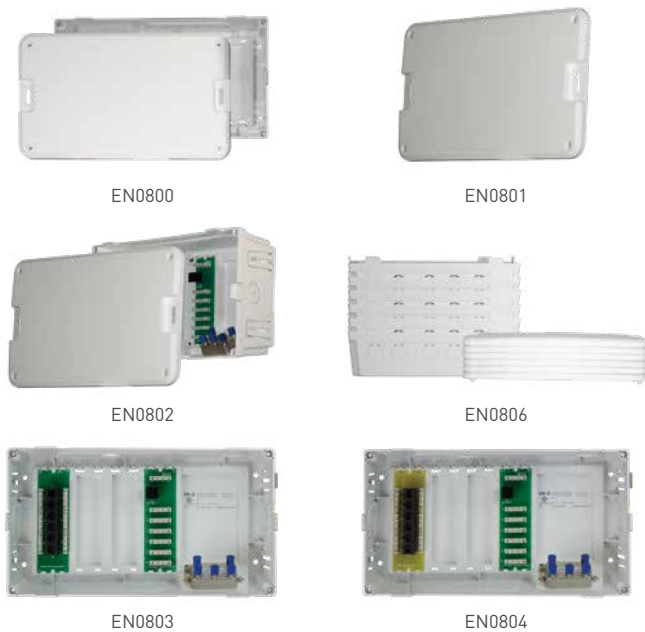

## MDU ENCLOSURE

PART NO.	DESCRIPTION
EN0800	8-Inch MDU Enclosure with Cover
EN0801	8-Inch MDU Enclosure Cover
EN0802	8-Inch MDU Enclosure Kit (6 phone, 4 video)
	INCLUDES: (1) ENCLOSURE AND COVER, (1) 6-WAY PHONE MODULE TM0106, (1) 4-WAY COAX SPLITTER VM0204
EN0803	8-Inch MDU Enclosure Kit (6 phone, 4 video)
	INCLUDES: (1) ENCLOSURE AND COVER, (1) 6-WAY PHONE MODULE TM0106, (1) 6-PORT CAT 5E DATA BOARD AC0506, (1) 4-WAY COAX SPLITTER VM0204
EN0804	8-Inch MDU Enclosure Kit (6 phone, 4 video)
	INCLUDES: (1) ENCLOSURE AND COVER, (1) 6-WAY PHONE MODULE TM0106, (1) 6-PORT CAT 6 DATA BOARD AC06 06, (1) 4-WAY COAX SPLITTER VM0204
EN0806	8-Inch MDU Enclosure Bulk Pack (6)

## MDU ENCLOSURE MODULES

PART NO.	DESCRIPTION
AC1042	MDU Mounting Bracket
AC0506	6-Port Cat 5e Data Board (For use with EN0800)
AC0606	6-Port Cat 6 Data Board (For use with EN0800)
TM0106	6-Way Telephone Board (For use with EN0800)
TM0404	Combo 4-Way Phone / 4 Port Cat 5e Data Board (For use with EN0800)
VM0104	4-Way Vertical 1 GHz Splitter (For use with EN0800)
VM0106	6-Way Vertical 1 GHz Splitter (For use with EN0800)
VM0108	8-Way Vertical 1 GHz Splitter (For use with EN0800)
VM0204	4-Way Vertical 2 GHz Splitter (For use with EN0800)
VM0206	6-Way Vertical 2 GHz Splitter (For use with EN0800)
VM0208	8-Way Vertical 2 GHz Splitter (For use with EN0800)



# VIDEO & VOICE DISTRIBUTION

## VOICE & VIDEO MODULES

### COMBO MODULES

DESCRIPTION	Basic 6x4 Combo (110 Punchdown)	10x8 Combo with RJ31X (RJ45)	10x8 Combo with RJ31X (110 Punchdown)	10x8 Combo with RJ31X MoCA Optimized	Trio Combo Module with Cat5e Data	Trio Combo Module with Cat6e Data
						
PART NO.	364400-04	CO1045	CO1110	CO2110-V1	CO1156	CO1166
Telecom Outlets	6	10	10	10	6	6
Video Outlets	4	8	8	8	8	8
Telecom Connections	110 Punchdown	RJ45	110 Punchdown	110 Punchdown	110 Punchdown	110 Punchdown
RJ31X Line Seizure	N	Y	Y	Y	Y	Y
Bandwidth	1 GHz	1 GHz	1 GHz	1.675 GHz	2 GHz	2 GHz
Dimensions	5 1/8" x 6 1/2"	5 1/8" x 6 1/2"	5 1/8" x 6 1/2"	5 1/8" x 6 1/2"	6 3/4" x 6 1/2"	6 3/4" x 6 1/2"

### VOICE MODULES

PART NO.	DESCRIPTION
TM1110	10-Way IDC Telephone Module with RJ31X
TM1045	10-Way RJ45 Telephone Module with RJ31X
1267062-01-V1	6-Way Basic Telecom Module with RJ31X



TM1110



TM1045



1267062-01-V1

### VIDEO MODULES

PART NO.	DESCRIPTION
VM1000	1x4 Enhanced Passive Video Splitter/Combiner
VM1002	1x8 Enhanced Passive Video Splitter/Combiner



VM1000



VM1002

### VIDEO SPLITTERS

PART NO.	DESCRIPTION
VM2201-V1	Single-Port RF Digital Cable Amplifier
VM2202-V1	Two-Way Digital Cable Splitter with Coax Network Support
VM2203-V1	Three-Way Digital Cable Splitter with Coax Network Support
VM2204-V1	Four-Way Digital Cable Splitter with Coax Network Support



VM2201-V1



VM2202-V1



VM2203-V1



VM2204-V1



VM2200-V1

### VIDEO ACCESSORIES

PART NO.	DESCRIPTION
VM2200-V1	Coax Network Signal Blocker



## HOME NETWORKING

## NETWORK MODULES



AC1000



AC1001



AC1012



AC1013



AC1014



AC1015



AC1058



AC1068

PART NO.	DESCRIPTION
AC1000	6-Port Cat 5e Network Interface Module
AC1001	6-Port Network Interface Module (Unpopulated)
AC1012	6-Port Cat 5e Network Interface Module
AC1013	6-Port Cat 6 Network Interface Module
AC1014	12-Port Cat 5e Network Interface Module
AC1015	12-Port Cat 6 Network Interface Module
AC1058	8-Port Cat 5e Network Interface Module
AC1068	8-Port Cat 6 Network Interface Module

# POWER MANAGEMENT

## POWER SUPPLIES



PW7760



PW7725



PW1030



PW1060



PW1458



PW1120



364569-02-V1



F7526



PW1006

## POWER MODULES



PW1013



PW1020



AC1031

## POWER SUPPLIES

PART NO.	DESCRIPTION
PW7760	12VDC, 18W Power Supply
PW7725	12VDC, 30W Power Supply
PW1030	24VDC, 30W Power Supply
PW1060	24VDC, 60W Power Supply
PW1458	48VDC, 60W Power Supply

## KITS

PART NO.	DESCRIPTION
PW1120	24VDC, 120W Power Supply Kit
	INCLUDES: (2) 24VDC, 60W POWER SUPPLIES (PW1060), (1) MOUNTING BRACKET (PW1006), (1) CUSTOM POWER STRIP, AND VELCRO STRAPS

## ACCESSORIES

PART NO.	DESCRIPTION
364569-02-V1	Surge Protected Duplex Power Kit
	INCLUDES: (1) SURGE PROTECTED DUPLEX OUTLET, (1) METAL JUNCTION BOX, AND (1) FACEPLATE KIT NOTE: TAMPER RESISTANT
F7526	Duplex Power Kit
	INCLUDES: (1) DUPLEX OUTLET, (1) METAL JUNCTION BOX AND (1) FACEPLATE KIT NOTE: TAMPER RESISTANT
PW1006	Twin Power Supply Bracket

PART NO.	DESCRIPTION
PW1013	Intuity Bridge Power Module
PW1020	Digital Audio Power Distribution Module
AC1031	Enclosure Power Strip Module, Half Width



# DATA CONNECTIVITY

## LOW VOLTAGE BRACKETS

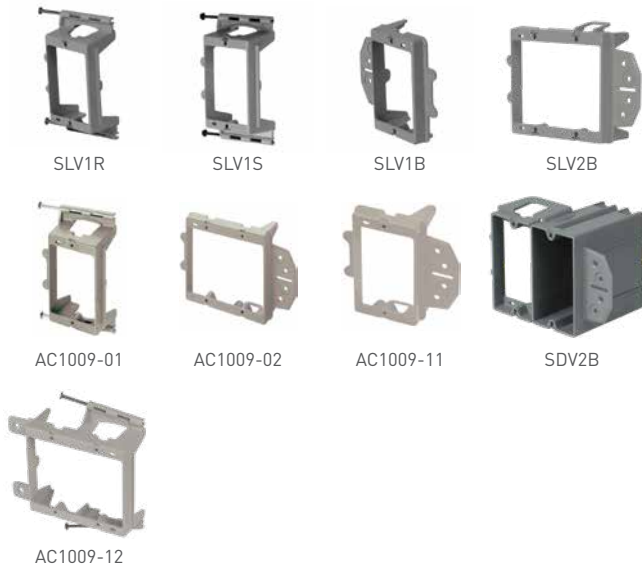

The Quick/Click® LV Brackets save time by securely mounting devices with a single tap.



## NEW CONSTRUCTION

PART NO.	DESCRIPTION
SLV1R	1-Gang, LV Bracket w/Nail, with Quick/Click®
SLV1S	1-Gang, LV Bracket w/Screw, with Quick/Click®
PLV1S	1-Gang, LV Bracket w/Screw, New Const.
SLV1B	1-Gang, LV Bracket Face Mount, with Quick/Click®
SLV2B	2-Gang, LV Bracket Face Mount, with Quick/Click®
AC1009-01	1-Gang, LV Bracket w/Nail, New Const.
AC1009-02	2-Gang, LV Bracket, Face Mount, New Const.
AC1009-11	1-Gang, LV Bracket, Face Mount, New Const.
AC1009-12	2-Gang, LV Bracket w/Nail, New Const.
SDV2B	2-Gang, LV Bracket, Face Mount, with Quick/Click®
PDV2B	2-Gang, LV Bracket, Face Mount
P100ND	1-Gang Slide Mount LV Bracket

## RETROFIT

PART NO.	DESCRIPTION
SLV1W	1-Gang, Metal Wing, with Quick/Click®
AC1010-01	1-Gang, LV Bracket, Retrofit
SLV2W	2-Gang, Metal Wing, with Quick/Click®
AC1010-02	2-Gang, LV Bracket, Retrofit
SLV3W	3-Gang, Metal Wing, with Quick/Click®
AC1010-03	3-Gang, LV Bracket, Retrofit
P100WD	1-Gang LV Bracket Extender

## DIVIDERS AND EXTENDERS

PART NO.	DESCRIPTION
LVDIV-1	LV Box Divider (12 Pack)
EXT1	1-Gang, 1/4" Box Extender (10 Pack)
EXT2	2-Gang, 1/4" Box Extender (10 Pack)

CRAFTED WITH DURABLE HEAVY-DUTY PLASTIC, ON-Q LV BRACKETS FEATURE AN OPEN BACK AND AN INTEGRATED CABLE MANAGEMENT SYSTEM FOR CLEAN CONNECTIONS AND EASY INSTALLATION.

# DATA CONNECTIVITY

## KEYSTONE INSERTS



AC3400



AC3401



WP346A-WH



WP3473-WH



WP3475-WH



WP3476-WH



WP3425-WH



WP3450-WH



WP3451-WH



WP3458-WH



WP3460-WH



WP3550-WH



WP3560-WH



WP3479-WH



WP3480-WH



WP3481-WH



WP3482-WH

## QUICK CONNECT INSERTS

PART NO.	DESCRIPTION
AC3400	Punch & Go Tool IMPROVES TERMINATION SPEEDS, REDUCES COMPROMISED CONNECTIONS AND INCREASES PRODUCTIVITY OF ANY QUICK CONNECT DATA INSERT.
AC3401	Punch & Go Tool Replacement Blade
WP346a-XX	Cat 6a Quick Connect RJ45 Keystone Insert
WP3473-XX	RJ25 6-Position, 6-Conductor Telephone Keystone Insert
10 COUNT BULK PACKS IN WH AND LA (WP3473-XX-10)	

COLORS: BK, BR, GY, IV, LA, WH

WP3475-XX	Cat 5e Quick Connect RJ45 Keystone Connector
10 COUNT BULK PACKS IN WH AND LA (WP3475-XX-10)	
50 COUNT BULK PACKS IN WH, LA AND BE (WP3475-XX-50)	
100 COUNT BULK PACKS IN WH (WP3475-WH-100)	
*100 PACK INCLUDES AC3400 PUNCH & GO TOOL	

COLORS: BE, BK, BR, GY, GN, IV, LA, OR, RE, WH, YE

WP3476-XX	Cat 6 Quick Connect RJ45 Keystone Connector
10 COUNT BULK PACKS IN WH, LA (WP3476-XX-10)	
50 COUNT BULK PACKS IN WH, LA AND BE (WP3476-XX-50)	
100 COUNT BULK PACKS IN WH (WP3476-WH-100)	

COLORS: BE, BK, BR, GY, IV, LA, OR, RE, WH

NOTE: THESE INSERTS ARE COMPATIBLE WITH THE AC3400 PUNCH & GO TOOL WHICH ALLOW FOR ALL WIRES TO BE TERMINATED AT ONCE.

## OTHER INSERTS

PART NO.	DESCRIPTION
WP3425-XX	RJ25 6P6C Keystone Connector
COLORS: BK, BR, IV, LA, WH	
WP3450-XX	Cat 5e RJ45 Keystone Connector
COLORS: BE, BK, BR, GY, IV, LA, OR, RE, WH	
WP3451-XX	Cat 5e RJ45 Keystone Coupler
COLORS: BK, WH	
WP3458-XX	Cat 5e Keyed RJ45 Keystone Connector
COLORS: BK, BR, IV, LA, WH	
WP3460-XX	Cat 6 RJ45 Keystone Connector
WP3550-XX	Snap & Go Cat 5e Keystone Connector
WP3560-XX	Snap & Go Cat 6 Keystone Connector
COLORS: BE, BK, BR, GY, IV, LA, OR, RE, WH	

## COAX VIDEO INSERTS

PART NO.	DESCRIPTION
WP3479-XX	Non-Recessed Coax Keystone F-Connector (1 GHz)
10 COUNT BULK PACKS IN WH OR LA (WP3479-XX-10)	
50 COUNT BULK PACK IN WH OR LA (WP3479-XX-50)	
WP3480-XX	Recessed Gold F-Connector (3 GHz)
WP3481-XX	Recessed Nickel F-Connector (3 GHz)
10 COUNT BULK PACKS IN WH OR LA (WP3481-XX-10)	
50 COUNT BULK PACK IN WH (WP3481-WH-50)	
WP3482-XX	Recessed Self-Terminating Keystone F-Connector (1 GHz)

COLORS: BK, BR, IV, LA, WH

COLOR KEY:

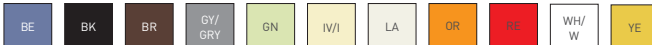

NOTE: Suffixes should be added to the end of all applicable part numbers.



# DATA CONNECTIVITY

## KEYSTONE INSERTS



WP3461-WH



WP3462-WH



WP3463-WH



WP3464-WH



WP3465-WH



WP3466-WH



WP1234-WH



WP3455-WH



WP1215-WH



WP3457-WH



WP3456-WH



KSRCAYW



KSRCARW



KSRCABW



KSRCABEW



KSRCAGNW



WP1220-WH



WP1221-WH



WP1210-WH



WP1211-WH



KSSCW



KSSCTW

## AUDIO/VIDEO INSERTS

PART NO.	DESCRIPTION
WP3461-XX	White Keystone RCA-to-F Connector
WP3462-XX	Red Keystone RCA-to-F Connector
WP3463-XX	Green Keystone RCA-to-F Connector
WP3464-XX	Blue Keystone RCA-to-F Connector
WP3465-XX	Yellow Keystone RCA-to-F Connector
WP3466-XX	Purple Keystone RCA-to-F Connector

COLORS: BK, BR, IV, LA, WH

WP1234-XX	HDMI Keystone Coupler
10 COUNT BULK PACK IN WH (WH1234-WH-10)	
WP3455-XX	Blank Keystone Insert
WP1215-XX	3.5MM Stereo Coupler
WP3457-XX	Audio Keystone Binding Post (Pair)
WP3456-XX	Speaker Keystone Binding Post

COLORS: BK, BR, IV, LA, WH

KSRCAYW	Keystone RCA-to-RCA (Yellow Insulator)
---------	--

COLORS: IV, LA, WH

KSRCARW	Keystone RCA-to-RCA (Red Insulator)
---------	-------------------------------------

COLORS: IV, LA, WH

KSRCABW	Keystone RCA-to-RCA (Black Insulator)
---------	---------------------------------------

COLORS: IV, LA, WH

KSRCABEW	Keystone RCA-to-RCA (Blue Insulator)
----------	--------------------------------------

COLORS: WH

KSRCAGNW	Keystone RCA-to-RCA (Green Insulator)
----------	---------------------------------------

COLORS: WH

## USB & FIBER INSERTS

PART NO.	DESCRIPTION
WP1220-XX	USB 2.0 A/A Coupler

COLORS: BK, BR, IV, LA, WH

WP1221-XX	USB 2.0 A/B Adapter
-----------	---------------------

COLORS: BK, BR, IV, LA, WH

WP1210-XX	MTRJ Coupler MM
-----------	-----------------

COLORS: IV, LA, WH

WP1211-XX	LC Coupler MM
-----------	---------------

COLORS: IV, LA, WH

KSSCXX	SC Coupler MM
--------	---------------

COLORS: IV, LA, WH

KSSTXX	ST Coupler MM
--------	---------------

COLORS: IV, LA, WH

### COLOR KEY:

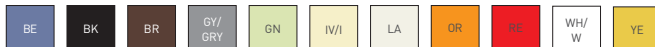

NOTE: Suffixes should be added to the end of all applicable part numbers.

# DATA CONNECTIVITY

## KEYSTONE WALL PLATES



WP3401-WH WP3402-WH WP3403-WH WP3404-WH



WP3406-WH WP3212-WH



WP3401-SS WP3402-SS WP3403-SS WP3406-SS



WP3300-WH WP3301-WH WP3302-WH WP3303-WH



WP3304-WH WP3306-WH



KTPDL1W KTPDL2W KTPDL3W KTPDL4W KTPDL6W

COLOR KEY:

BK	SS	GY/GRY	WH/W	LA	IV/I	NI
----	----	--------	------	----	------	----

NOTE: Suffixes should be added to the end of all applicable part numbers.

## WALL PLATES

PART NO.	DESCRIPTION
WP3401-XX	1-Gang, 1-Port Wall Plate 10 COUNT BULK PACK IN WH OR LA (WP3401-XX-10) 25 COUNT BULK PACK IN WH OR LA (WP3401-XX-25)
WP3402-XX	1-Gang, 2-Port Wall Plate 10 COUNT BULK PACK IN WH OR LA (WP3402-XX-10) 25 COUNT BULK PACK IN WH OR LA (WP3402-XX-25)
WP3403-XX	1-Gang, 3-Port Wall Plate 10 COUNT BULK PACK IN WH (WP3403-WH-10)
WP3404-XX	1-Gang, 4-Port Wall Plate
WP3406-XX	10 COUNT BULK PACK IN WH (WP3406-WH-10)

COLORS: BK, BR, IV, LA, WH, GY

WP3212-XX	2-Gang, 12-Port Wall Plate
-----------	----------------------------

COLORS: IV, LA, WH  
DIMENSIONS: 1-GANG: 2.9375" X 4.6875" 2-GANG: 8.375" X 4.6875"

## STAINLESS STEEL WALL PLATES

PART NO.	DESCRIPTION
WP3401-SS	1-Gang, 1-Port Wall Plate, Stainless Steel
WP3402-SS	1-Gang, 2-Port Wall Plate, Stainless Steel
WP3403-SS	1-Gang, 3-Port Wall Plate, Stainless Steel
WP3404-SS	1-Gang, 4-Port Wall Plate, Stainless Steel
WP3406-SS	1-Gang, 6-Port Wall Plate Stainless Steel

DIMENSIONS: 1-GANG: 2.9375" X 4.6875"

## OVERSIZED WALL PLATES

PART NO.	DESCRIPTION
WP3300-XX	1-Gang, Blank Oversized Wall Plate
WP3301-XX	1-Gang, 1-Port Oversized Wall Plate 10 COUNT BULK PACK IN WH (WP3301-WH-10)
WP3302-XX	1-Gang, 2-Port Oversized Wall Plate 10 COUNT BULK PACK IN WH (WP3302-WH-10)
WP3303-XX	1-Gang, 3-Port Oversized Wall Plate
WP3304-XX	1-Gang, 4-Port Oversized Wall Plate
WP3306-XX	1-Gang, 6-Port Oversized Wall Plate

COLORS: WH, LA  
DIMENSIONS: 1-GANG: 3.3125" X 5.0625"

## LABELED WALL PLATES

PART NO.	DESCRIPTION
KTPDL1XX	1-Gang, 1-Port Keystone Labeled Wall Plate
KTPDL2XX	1-Gang, 2-Port Keystone Labeled Wall Plate
KTPDL3XX	1-Gang, 3-Port Keystone Labeled Wall Plate
KTPDL4XX	1-Gang, 4-Port Keystone Labeled Wall Plate
KTPDL6XX	1-Gang, 6-Port Keystone Labeled Wall Plate

COLORS: I, LA, W  
DIMENSIONS: 1-GANG: 2.9375" X 4.6875"

# DATA CONNECTIVITY

## WALL PLATES



TP13W



TP23W



TP26W



TP262W



TP263W



TP264W

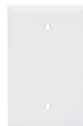

TPJ13W



TPJ26W



TPJ262W



TPJ263W



TPJ264W



RWP26XX



RWP262XX



RWP263XX



RWP264XX

## STANDARD DECORATOR WALL PLATES

PART NO.	DESCRIPTION
TP13XXX	1-Gang Blank Wall Plate
TP23XXX	2-Gang Blank Wall Plate
TP26XXX	1-Gang Decorator Wall Plate
TP262XXX	2-Gang Decorator Wall Plate
TP263XXX	3-Gang Decorator Wall Plate
TP264XXX	4-Gang Decorator Wall Plate

COLORS:	BK, I, LA, W, GRY (FOR BROWN, LEAVE BLANK)
DIMENSIONS:	1-GANG: 2.9375" x 4.6875"      2-GANG: 4.75" x 4.6875"
	3-GANG: 6.563" x 4.6875"      4-GANG: 8.375" x 4.6875"

## JUMBO DECORATOR WALL PLATES

PART NO.	DESCRIPTION
TPJ13XXX	Jumbo 1-Gang Blank Wall Plate
TPJ26XXX	Jumbo 1-Gang Wall Plate
TPJ262XXX	Jumbo 2-Gang Wall Plate
TPJ263XXX	Jumbo 3-Gang Wall Plate
TPJ264XXX	Jumbo 4-Gang Wall Plate

COLORS:	BK, I, LA, W, GRY (FOR BROWN, LEAVE BLANK)
DIMENSIONS:	1-GANG: 3.3125" x 5.0625"      2-GANG: 5.125" x 5.0625"
	3-GANG: 6.9375" x 5.0625"      4-GANG: 8.75" x 5.0625"

## RADIANT WALL PLATES

PART NO.	DESCRIPTION
RWP26XX	Screwless Wall Plate, 1-Gang
RWP262XX	Screwless Wall Plate, 2-Gang
RWP263XX	Screwless Wall Plate, 3-Gang
RWP264XX	Screwless Wall Plate, 4-Gang

COLORS:	W, LA, I, GRY, BK, NICC6, DBCC6 (FOR BROWN, LEAVE BLANK)
---------	--

### COLOR KEY:



NOTE: Suffixes should be added to the end of all applicable part numbers. OMIT COLOR CODE TO ORDER BROWN DEVICE.



# DATA CONNECTIVITY

## STRAPS



WP3410-WH



WP3411-WH



WP3412-WH



WP3413-WH



WP3414-WH



WP3416-WH

PART NO.	DESCRIPTION
WP3410-XX	Blank Decorator Outlet Strap
WP3411-XX	1-Port Decorator Outlet Strap
	10 COUNT BULK PACK IN WH (WP3411-WH-10)
WP3412-XX	2-Port Decorator Outlet Strap
	10 COUNT BULK PACK IN WH (WP3412-WH-10)
WP3413-XX	3-Port Decorator Outlet Strap
	10 COUNT BULK PACK IN WH (WP3413-WH-10)
WP3414-XX	4-Port Decorator Outlet Strap
WP3416-XX	6-Port Decorator Outlet Strap

COLORS: BK, BR, IV, LA, WH, GY

## SURFACE MOUNT BOXES



WP3409-WH



WP3501-WH



WP3502-WH



WP3504-WH



WP3506-WH

PART NO.	DESCRIPTION
WP3409-XX	Single Gang Surface Mount Box
WP3501-XX	Surface Mount Box 1-Port
WP3502-XX	Surface Mount Box 2-Port
WP3504-XX	Surface Mount Box 4-Port
WP3506-XX	Surface Mount Box 6-Port

COLORS: IV, LA, WH

# DATA CONNECTIVITY

## PRE-MOLDED WALL PLATES & STRAPS



PART NO.	DESCRIPTION
TPTE1XX	2-Line Telephone Jack Wall Plate (4 Conductor Configuration)
COLORS:	BK, I, LA, W, GRY
TPTE2XX	Dual 2-Line Telephone Jack Wall Plate (4 Conductor Configuration)
COLORS:	BK, I, LA, W
WMTE14X	Modular Wall Mount Telephone Jack for Hanging Phones
COLORS:	W, LA, I
SMTE14I	Surface Mount Modular 2-Line Telephone Jack (4 Conductor Configuration)
COLORS:	I
TPCATVXX	1 GHz Coaxial Connector & Wall Plate
COLORS:	I, LA, W, BK
TPCATV2XX	Dual 1 GHz Coaxial Connector Wall Plate
COLORS:	I, LA, W, BK
TPTELTVXX	1 GHz Coaxial Connector & 2-Line Phone Jack Wall Plate
COLORS:	I, LA, W, BK
26TELTVCC10	1 GHz Coaxial Connector & 2-Line Phone Jack with 1-Piece Molded Decorator Plate
COLORS:	BK, I, LA, W
WP2002-WH	1-Gang 6P6C RJ25 Terminating Wall Phone Plate
COLORS:	WH
WP3467-XX	Keystone Wall Phone Plate
COLORS:	WH, SS (Stainless Steel)
26TE14XX	Decorator 2-Line Telephone Jack (4 Conductor Configuration)
COLORS:	I, LA, W
26TE16XX	Decorator 3-Line Telephone Jack (6 Conductor Configuration)
COLORS:	I, W
26CATVXX	Decorator 1GHz Coaxial Connector
COLORS:	I, LA, W

## PRE-CONFIGURED PLATES & STRAPS



PART NO.	DESCRIPTION
WP3210-XX	1-Port Strap, 1RJ45
WP3211-XX	2-Port Strap Phone/TV
WP3220-XX	2-Port Strap Phone/Data
WP3422-XX	4-Port Strap Phone/Data, TV/AUX
COLORS:	BK, LA, WH

### COLOR KEY:



**NOTE:** Suffixes should be added to the end of all applicable part numbers. OMIT COLOR CODE TO ORDER BROWN DEVICE.

# HOME THEATER SOLUTIONS

## HOME THEATER WALL PLATES & STRAPS



F9004-WH



F9005-WH



F9006-WH



F9008-WH-V1



WP9009-XX-V1



WP1011-WH

PART NO.	DESCRIPTION
F9004-XX	5.1 Home Theater Strap
COLORS:	BK, BR, IV, LA, WH
F9005-XX	2-Speaker Connection Strap
COLORS:	BK, BR, IV, LA, WH
F9006-XX	Single Speaker Connection Strap
COLORS:	BK, BR, IV, LA, WH
F9008-XX-V1	5.1 Home Theater Strap with Wall Plate
COLORS:	LA, WH
WP9009-XX-V1	7.1 Home Theater Strap with Wall Plate
COLORS:	DM, LA, WH
WP1011-WH	Pre-Configured HDMI 2 Port Strap
COLORS:	BK, LA, WH

## CABLE ACCESS WALL PLATES



WP1014-WH



WP1014-XX-V1



WP9001-WH



WP9002-WH

PART NO.	DESCRIPTION
WP1014-XX	Cable Access Strap
	5 COUNT BULK PACK IN WP1014-WH-5 (5 PACK)
WP1014-XX-V1	Cable Access Strap with Wall Plate
COLORS:	BK, LA, WH
WP9001-XX	Single Gang Bullnose Wall Plate
COLORS:	BK, LA, WH
WP9002-XX	Double Gang Bullnose Wall Plate
COLORS:	BK, LA, WH

COLOR KEY:



NOTE: Suffixes should be added to the end of all applicable part numbers. OMIT COLOR CODE TO ORDER BROWN DEVICE.



# HOME THEATER SOLUTIONS

## HOME THEATER CONNECTIONS



HT2102-WH-V1



HT2103-WH-V1



HT2000-WH-V1



HT2001-WH-V1



HT2004-WH-V1

PART NO.	DESCRIPTION
HT2102-WH-V1	Flat Panel TV Connection Kit
	INCLUDES: (1) HDMI 2-PORT STRAP, (1) CABLE ACCESS STRAP (2) WALL PLATES, (1) 9FT HIGH SPEED HDMI CABLE
HT2103-WH-V1	Home Theater Connection Kit
	INCLUDES: (1) RECESSED BRACKET WITH CABLE ACCESS STRAP, (1) 1-GANG WALL BOX, (1) TAMPER RESISTANT DECORATOR RECEPTACLE, (1) WALL PLATE
HT2000-WH-V1	HDMI In-Wall Connection Kit
	INCLUDES: (2) CABLE ACCESS STRAPS (2) WALL PLATES, (1) 9FT HIGH SPEED HDMI WITH ETHERNET CABLE
HT2001-WH-V1	HDMI Premium In-Wall Connection Kit
	INCLUDES: (1) HDMI 2-PORT STRAP, (1) CABLE ACCESS STRAP (2) WALL PLATES, (1) 9FT HIGH SPEED HDMI CABLE
HT2004-WH-V1	Dual Cable Access Kit
	INCLUDES (2) CABLE ACCESS BRUSH STRAPS AND (2) CORRESPONDING WALL PLATES

# HOME THEATER SOLUTIONS

## IN-WALL TV POWER KITS



CPT306W-V1



HT22U2-WH-R6



HT22U2-BK-R6



HT22U2-WH-R6C



In-Wall TV Power Kit

PART NO.	DESCRIPTION
CPT306W-V1	TV In-Wall Power Kit, White
	INCLUDES: (1) POWER OUTPUT MODULE, (1) 6FT PREWIRED CORD, (1) POWER INPUT MODULE, (1) DRYWALL BRACKET, (1) POWER CORD & CUTOUT TEMPLATE
HT22U2-WH-R6	Pro TV In-Wall Power & Cable Management Kit, White
	INCLUDES: (1) UNASSEMBLED POWER OUTPUT MODULE, (1) 6FT PREWIRED CORD, (1) UNASSEMBLED POWER INPUT MODULE, (1) DRYWALL BRACKET, (1) POWER CORD & CUTOUT TEMPLATE
HT22U2-BK-R6	Pro TV In-Wall Power & Cable Management Kit, Black
	(1) UNASSEMBLED POWER OUTPUT MODULE, (1) 6FT PREWIRED CORD, (1) UNASSEMBLED POWER INPUT MODULE, (1) DRYWALL BRACKET, (1) POWER CORD & CUTOUT TEMPLATE
HT22U2-WH-R6C	Pro TV In-Wall Power & Cable Management Kit with (2)10Ft HDMI
	(1) UNASSEMBLED POWER OUTPUT MODULE, (1) 6FT PREWIRED CORD, (1) UNASSEMBLED POWER INPUT MODULE, (1) DRYWALL BRACKET, (1) POWER CORD & CUTOUT TEMPLATE, (2) 10FT HDMI CABLES

## HOME THEATER ACCESSORIES



AC2102

PART NO.	DESCRIPTION
AC2102	TV Box, New Construction Bracket
	NOTE: USE WITH HT2102-WH-V1 AND HT2103-WH-V1

# AV CABLING

## HDMI CABLES



The Premium HDMI Cable Certification Program ensures each tested cable can support the full 18Gbps bandwidth which is needed for feature-rich 4K/UltraHD content.

Cables that are tested and certified will carry this tamper-proof, anti-counterfeit label to confirm they have met the standards of the Premium HDMI Program.



## 18GBPS PREMIUM HIGH SPEED HDMI CABLE WITH ETHERNET

PART NO.	DESCRIPTION
AC2MP1-BK	1 Meter Premium High Speed HDMI Cable with Ethernet
AC2MP2-BK	2 Meter Premium High Speed HDMI Cable with Ethernet
AC2MP3-BK	3 Meter Premium High Speed HDMI Cable with Ethernet
AC2MP4-BK	4 Meter Premium High Speed HDMI Cable with Ethernet
AC2AP5-BK	5 Meter Premium High Speed HDMI Cable with Ethernet
AC2AP7-BK	7 Meter Premium High Speed HDMI Cable with Ethernet

NOTES: HDMI CERTIFIED TO ENSURE FULL 18GBPS BANDWIDTH NECESSARY FOR 4K ULTRAHD

## 18GBPS PREMIUM HIGH SPEED HDMI SLIM LINE CABLE WITH ETHERNET

PART NO.	DESCRIPTION
AC3MP1-WH	1 Meter Premium High Speed HDMI Slim Line Cable with Ethernet, White
AC3MP1-BK	1 Meter Premium High Speed HDMI Slim Line Cable with Ethernet, Black - not shown
AC3MP2-WH	2 Meter Premium High Speed HDMI Slim Line Cable with Ethernet, White
AC3MP2-BK	2 Meter Premium High Speed HDMI Slim Line Cable with Ethernet, Black - not shown

NOTES: HDMI CERTIFIED TO ENSURE FULL 18GBPS BANDWIDTH NECESSARY FOR 4K ULTRAHD



## 18GBPS AOC FIBER HDMI CABLES

PART NO.	DESCRIPTION
AC2F10-BK	10 Meter Fiber HDMI cable
AC2F20-BK	20 Meter Fiber HDMI cable
AC2F50-BK	50 Meter Fiber HDMI cable
AC2F75-BK	75 Meter Fiber HDMI cable

## 18GBPS ACTIVE COPPER HDMI CABLES

PART NO.	DESCRIPTION
ACAA10-BK	10 Meter Active Copper HDMI cable
ACAA15-BK	15 Meter Fiber HDMI cable

# AV CABLING

## HDMI CABLES



AC1030



AC2100



AC2101



AC2103-V1

## 10GBPS HIGH SPEED HDMI WITH ETHERNET SLIM LINE CABLE

PART NO.	DESCRIPTION
AC3M01-WH-V1	1 Meter High Speed HDMI with Ethernet Slim Line Cable
AC3M02-WH-V1	2 Meter High Speed HDMI with Ethernet Slim Line Cable
AC3M04-WH-V1	4 Meter High Speed HDMI with Ethernet Slim Line Cable

## 10GBPS HIGH SPEED HDMI CABLES WITH ETHERNET

PART NO.	DESCRIPTION
AC2M00-BK	0.7 Meter HDMI cable w/Ethernet
AC2M01-BK	1 Meter HDMI cable w/Ethernet
AC2M02-BK	2 Meter HDMI cable w/Ethernet
AC2M03-BK	3 Meter HDMI cable w/Ethernet
AC2M04-BK	4 Meter HDMI cable w/Ethernet
AC2M05-BK	5 Meter HDMI cable w/Ethernet
AC2M07-BK	7.5 Meter HDMI cable w/Ethernet
AC2M10-BK	10 Meter HDMI cable w/Ethernet
AC2M15-BK	15 Meter HDMI cable w/Ethernet
AC2M20-BK	20 Meter HDMI cable w/Ethernet

## ACCESSORIES

PART NO.	DESCRIPTION
AC1030	HDBaseT HDMI Extender  THE AC1030 KIT EXTENDS HDMI AND ETHERNET SIGNALS UP TO 328 FEET USING CAT 5E OR CAT 6 WIRING. IT SUPPORTS 3D VIDEO AND 1080P RESOLUTION, WHILE DUAL IR TARGETS ALLOW THE SOURCE DEVICE TO RECOGNIZE REMOTE COMMANDS AT A SECONDARY LOCATION.  KIT INCLUDES: TRANSMITTER AND RECEIVER UNITS, IR TARGETS AND TWO POWER SUPPLIES.
AC2100	HDMI Repeater  COUPLES UP TO (2) 20 FT. HDMI CABLES.
AC2101	HDMI Hinged Coupler  CONNECT 2 CABLES TO MAKE 90-DEGREE BENDS.
AC2103-V1	Hinged HDMI Male-to-Female Adapter



# AV CABLING

## AUDIO/VIDEO CABLES



AC2006-BK



AC2103-BK



AC2203-BK



AC2303-BK



AC2403-BK



AC2406-BK



AC2501-BK



AC2506-BK



AC2606-BK



AC2701-BK



AC2702-BK



AC2704-BK



AC2706-BK



CM1015



CM1016



CM1017



CM1018

## COMPOSITE

PART NO.	DESCRIPTION
AC2006-BK	6 Feet Composite Vid L/R Audio Cable
AC2012-BK	12 Feet Composite Vid L/R Audio Cable

## UNIVERSAL

PART NO.	DESCRIPTION
AC2103-BK	3 Feet Universal 1 Subwoofer Cable
AC2106-BK	6 Feet Universal 1 Subwoofer Cable
AC2112-BK	12 Feet Universal 1 Subwoofer Cable
AC2125-BK	25 Feet Universal 1 Subwoofer Cable
AC2203-BK	3 Feet Universal 2 L/R Audio Cable
AC2206-BK	6 Feet Universal 2 L/R Audio Cable
AC2303-BK	3 Feet Universal 3 Component Video Cable
AC2306-BK	6 Feet Universal 3 Component Video Cable
AC2312-BK	12 Feet Universal 3 Component Video Cable
AC2325-BK	25 Feet Universal 3 Component Video Cable

## TOSLINK

PART NO.	DESCRIPTION
AC2403-BK	3 Feet Toslink w/Mini Audio Cable
AC2406-BK	6 Feet Toslink w/Mini Audio Cable
AC2412-BK	12 Feet Toslink w/Mini Audio Cable
AC2425-BK	25 Feet Toslink w/Mini Audio Cable

## 3.5 MM

PART NO.	DESCRIPTION
AC2501-BK	6 Inches Stereo 3.5 mm Y M/2F Adapter
AC2506-BK	6 Feet Stereo 3.5 mm M/F Audio Cable
AC2512-BK	12 Feet Stereo 3.5 mm M/F Audio Cable
AC2606-BK	6 Feet Stereo 3.5 mm M/M Audio Cable
AC2612-BK	12 Feet Stereo 3.5 mm M/M Audio Cable
AC2625-BK	25 Feet Stereo 3.5 mm M/M Audio Cable

## RCA

PART NO.	DESCRIPTION
AC2701-BK	6 Inches RCA Y M/2F Adapter
AC2702-BK	6 Inches RCA Y F/2M Adapter
AC2704-BK	RCA Coupler Pair
AC2706-BK	6 Feet 3.5 mm to L/R RCA Audio Cable
AC2712-BK	12 Feet 3.5 mm to L/R RCA Audio Cable
AC2725-BK	25 Feet 3.5 mm to L/R RCA Audio Cable
CM1015	RCA to RCA Y Splitter Cable - Yellow (1 ft)
CM1016	RCA to RCA Y Splitter Cable - White (1 ft)
CM1017	RCA to RCA Patch Cable (1 ft)
CM1018	Audio Mini Patch Cable (1 ft)

# AV CABLING

## PATCH CABLES



AC6A07-GY-V1



### CAT 6A PATCH CABLES

PART NO.	DESCRIPTION
AC6A01-GY-V1	1 Foot Cat 6a Patch Cable
AC6A02-GY-V1	2 Foot Cat 6a Patch Cable
AC6A03-GY-V1	3 Foot Cat 6a Patch Cable
AC6A07-GY-V1	7 Foot Cat 6a Patch Cable
AC6A14-GY-V1	14 Foot Cat 6a Patch Cable
AC6A25-GY-V1	25 Foot Cat 6a Patch Cable
AC6A50-GY-V1	50 Foot Cat 6a Patch Cable

- 500MHZ PATCH CABLE FULLY SUPPORTS 10 GIGABIT ETHERNET SPEEDS
- UL VERIFIED TO SUPPORT THE CAT 6a PERFORMANCE PATCH CABLE SPECIFICATION
- SNAGLESS OVERMOLD PREVENTS INSERTION TAB FROM CATCHING ON OTHER CABLES
- 26 AWG STRANDED PATCH CABLE



AC3607-BE-V1



### CAT 6 PATCH CABLES

PART NO.	DESCRIPTION
AC3601-BE-V1	1 Foot Cat 6 Patch Cable
AC3602-BE-V1	2 Foot Cat 6 Patch Cable
AC3603-BE-V1	3 Foot Cat 6 Patch Cable
AC3607-BE-V1	7 Foot Cat 6 Patch Cable
AC3614-BE-V1	14 Foot Cat 6 Patch Cable
AC3625-BE-V1	25 Foot Cat 6 Patch Cable
AC3650-BE-V1	50 Foot Cat 6 Patch Cable

- 250MHZ PATCH CABLE FULLY SUPPORTS 10 GIGABIT ETHERNET SPEEDS
- UL VERIFIED TO SUPPORT THE CAT 6 PERFORMANCE PATCH CABLE SPECIFICATION
- SNAGLESS OVERMOLD PREVENTS INSERTION TAB FROM CATCHING ON OTHER CABLES
- 24 AWG STRANDED PATCH CABLE



AC3507-WH-V1



### CAT 5E PATCH CABLES

PART NO.	DESCRIPTION
363201-26-V1	1 Foot Cat 5e Patch Cable
363201-25-V1	2 Foot Cat 5e Patch Cable
AC3503-WH-V1	3 Foot Cat 5e Patch Cable
AC3507-WH-V1	7 Foot Cat 5e Patch Cable
AC3514-WH-V1	14 Foot Cat 5e Patch Cable
AC3525-WH-V1	25 Foot Cat 5e Patch Cable
AC3550-WH-V1	50 Foot Cat 5e Patch Cable

- 100MHZ PATCH CABLE SUPPORTS 10 GIGABIT ETHERNET SPEEDS
- UL VERIFIED TO SUPPORT THE CAT 5e PERFORMANCE PATCH CABLE SPECIFICATION
- SNAGLESS OVERMOLD PREVENTS INSERTION TAB FROM CATCHING ON OTHER CABLES
- 24 AWG STRANDED PATCH CABLE



# CABLE TIES & PATCH PANELS

## CABLE TIES

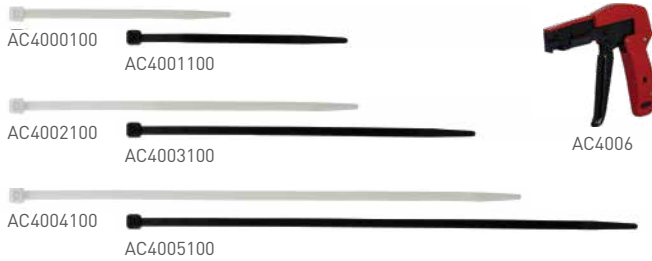

PART NO.	DESCRIPTION
AC4000100	4.75 Inch, Natural, Cable Ties (100 Pack)
AC4001100	4.75 Inch, Black, Cable Ties (100 Pack)
AC4002100	7.5 Inch, Natural, Cable Ties (100 Pack)
AC4003100	7.5 Inch, Black, Cable Ties (100 Pack)
AC4004100	11 Inch, Natural, Cable Ties (100 Pack)
AC4005100	11 Inch, Black, Cable Ties (100 Pack)
AC4006	Cable Tie Tool

NOTE: FOR CONSISTANT AND CLEAN INSTALLATIONS USE WITH CABLE TIE TOOL, AC4006

## PATCH PANELS

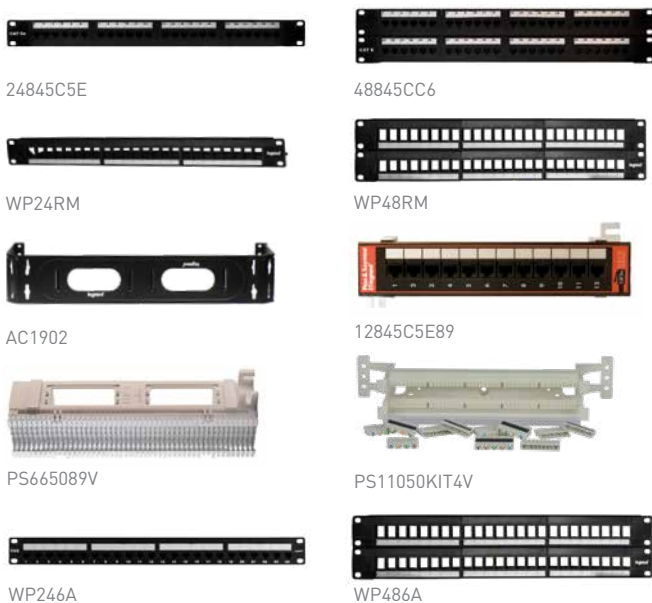

PART NO.	DESCRIPTION
24845C5E	Category 5e 24-Port T568A/B Universal Wiring
48845C5E	Category 5e 48-Port T568A/B Universal Wiring
24845C6	Category 6 24-Port T568A/B Universal Wiring
48845C6	Category 6 48-Port T568A/B Universal Wiring
	<ul style="list-style-type: none"> <li>• 24 PORT PATCH PANEL USES 1 RACK MOUNT SPACE</li> <li>• 48 PORT PATCH PANEL USES 2 RACK MOUNT SPACES</li> <li>• 110 PUNCHDOWN REAR TERMINATION</li> </ul>
WP24RM	24 Port Keystone Blank
WP48RM	48 Port Keystone Blank
AC1902	2 U Wall Mount Rack with Extenders
12845C5E89	12-Port T568A/B Universal Wiring
PS665089V	50-Pair 66 Block, Unwired & Mounting Bracket
PS11050KIT4V	50-Pair 110 Kit with Legs
	INCLUDES: 110 PUNCH DOWN BLOCK WITH STAND-OFF LEGS, 10 C5 CLIPS, AND LABEL BAR.
WP246A	Cat 6A 24 Port Rack Mount Patch Panel
WP486A	Cat 6A 48 Port Rack Mount Patch Panel

# INSTALLATION TOOLS & CONNECTORS

## TOOLS



362721-02



363292-01



364555-01



AC1018



AC3007

PART NO.	DESCRIPTION
362721-02	RG-6 Coax Stripper
363292-01	Cat 5e Strip and Fit Tool
364555-01	EZ RJ-45 Modular Plug Hand Tool
AC1018	Radial Taper Compression Tool (use with 364246-01 Coax F Plug)
AC3007	Adjustable Compression Tool

## CONNECTORS



364405-01



AC3000100



AC345050



AC346025



WP3483-01



AC3001-10



AC3002-10



AC3003-10



AC3004-10



AC3005-10



AC3006-10



AC3008-10

PART NO.	DESCRIPTION
364405-01	High Performance RJ45 Modular Plugs (25 Pack)
AC3000100	360 Conical Coax F Plug (100 Pack)
AC345050	EZ-RJ45 Modular Cat 5e Plug (50 Pack)
AC346025	EZ-RJ45 Modular Cat 6 Plug (25 Pack)
WP3483-01	Banana Plugs (pair)
AC3001-10	Compression RG6U/Quad F Plug, 10 Pack
AC3002-10	Compression RG6U/Quad 3 GHz F Jack, 10 Pack
AC3003-10	Compression RG6U/Quad Shield BNC Plug, 10 Pack
AC3004-10	Compression RG6U/Quad Shield RCA Plug, 10 Pack
	50 PACK ALSO AVAILABLE, AC3004-50
AC3005-10	Compression RG6U/Quad Shield Right Angle RCA Plug
AC3006-10	Nickle F-81 1 GHz Coupler, 10 Pack
	50 PACK ALSO AVAILABLE, AC3006-50
AC3008-10	Compression RG6U/Quad F Plug 10 Pack
	50 PACK ALSO AVAILABLE, AC3008-50

# RESOURCES & SUPPORT

## TECH SUPPORT

Need help on the job? Legrand's expert team of support specialists are available Monday through Friday, from 8:30 am to 6:30 pm Eastern Time, to answer your product or installation questions. The staff can be reached during these standard hours by any of the below options:

**Phone:** 800.223.4162, Option #3, then Option #2 or 1-717-546-5412

**Email:** [technical.support-hs@legrand.us](mailto:technical.support-hs@legrand.us)

**Live Chat:** available through the [www.legrand.us](http://www.legrand.us) website

## CUSTOMER SERVICE

Friendly and knowledgeable, our team can handle a wide variety of needs and requests – from order processing to system registration – and is available Monday through Friday, from 9 am to 6 pm Eastern Time.

**Phone:** 844.334.8044

**Email (general inquiries):** [customer.support.lv@legrand.us](mailto:customer.support.lv@legrand.us)

**Email (orders):** [orders.lv@legrand.us](mailto:orders.lv@legrand.us)

## TRAINING & SALES COLLATERAL

Knowledge is power, and Legrand offers a wealth of product, industry, and installation knowledge through our in-person and online courses.

Visit the Legrand University at <http://go.bluevolt.com/Legrand> for convenient online courses you can complete at your own pace, recordings of past webinars to catch anything you may have missed, and a complete schedule of upcoming FREE webinars and in-person training events.

Access key On-Q sales collateral & downloads on our Legrand | AV Sales app! Available to download on the iOS App Store or view the platform on the web version at <https://vantage.v4.storyslab.com/login>.

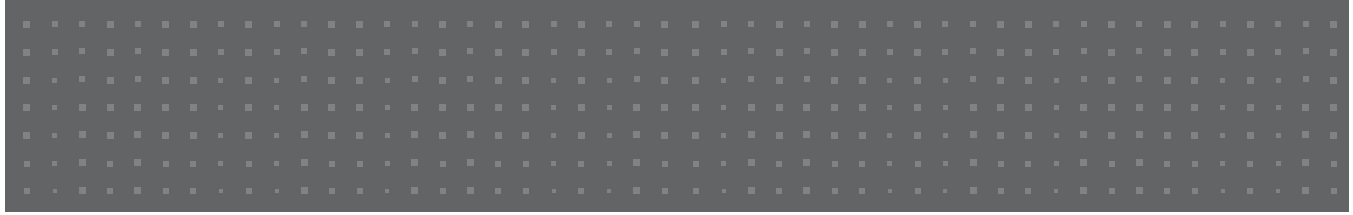

designed to be better™



301 Fulling Mill Road, Suite G  
Middletown, PA 17057  
(800) 321-2343  
[www.legrand.us/onq](http://www.legrand.us/onq)

9024 Keele Street,  
Vaughan, Ontario L4K 2N2  
(800) 723-5175  
[www.legrand.ca](http://www.legrand.ca)