

# FLOOR BOX SYSTEMS

## Quick Selection Guide

Wiremold® Floor Boxes are TopGuard protected to meet and exceed the UL scrub water exclusion requirement.



### Floor Boxes for Wood Floor (continued)

RESIDENTIAL BOXES									
<b>862 Series</b>	Round	Single	1 Gang	PVC	N/A	3/4" Trade Size	Brass, Brushed Aluminum	Tile, Carpet	Included with Kit or 895, 896 Series
<b>WMFB Series, WMFB1</b>	Square	Single	1 Gang	PVC	N/A	1/2" & 3/4" Trade Size	Brass, Brushed Nickel	Tile, Carpet	Included with Kit
<b>WMFB Series, WMFB2</b>	Square	Dual	2 Gangs	PVC	N/A	1/2" & 3/4" Trade Size	Brass, Brushed Nickel	Tile, Carpet	Included with Kit
<b>863 Series</b>	Round	Dual	2 Gangs	PVC	N/A	1/2" Trade Size Romex strain relief pass-through opening for communications	Brass, Brushed Aluminum	Carpet	Included with Kit

### Raised Floor Boxes

ACCESS FLOOR DEPTH: 2 1/2"									
Box Model	Box Type	Service Capability	Box Capacity	Box Construction	Depth Behind Device Plates	KO Sizes	Cover Construction	Cover Type	Cover & Flange Part Nos.
<b>AF Series SAF 2 1/2</b>	Square	Triple	3 Gangs	Steel	1 3/4" [44mm]	1/2" & 3/4" Trade Size	Polycarbonate	Tile, Carpet	Included with Box
CONCRETE FLOOR DEPTH: 4"									
<b>AF Series SAF 2 1/2</b>	Square	Triple	3 Gangs	Steel	1 3/4" [44mm]	1/2" & 3/4" Trade Size	Polycarbonate	Tile, Carpet	Included with Box
<b>AC Series AC8840</b>	Square	Single	2 Gangs	Steel	1 1/2" [38mm]	1/2" & 3/4" Trade Size	Die-Cast Zinc	Carpet	Included with Box
<b>AC Series AC8104</b>	Square	Dual	4 Gangs	Steel	1 5/8" [41mm]	1/2" & 3/4" Trade Size	Die-Cast Zinc	Carpet	Included with Box
ACCESS FLOOR DEPTH: 5"									
<b>AF Series SAF 2 1/2</b>	Square	Triple	3 Gangs	Steel	1 3/4" [44mm]	1/2" & 3/4" Trade Size	Polycarbonate	Tile, Carpet	Included with Box
<b>AF Series AF1</b>	Square	Triple	4 Gangs	Die-Cast Aluminum	2 3/4" [70mm]	1/2" & 3/4" Trade Size	Polycarbonate	Tile, Carpet	Included with Box
<b>AF Series AF3</b>	Square	Triple	8 Gangs	Die-Cast Aluminum	2 3/4" [70mm]	1/2" & 3/4" Trade Size	Polycarbonate	Tile, Carpet	Included with Box
<b>AC Series AC8840</b>	Square	Single	2 Gangs	Steel	1 1/2" [38mm]	1/2" & 3/4" Trade Size	Die-Cast Zinc	Carpet	Included with Box
<b>AC Series AC8850</b>	Square	Single	4 Gangs	Steel	2" [51mm]	1/2" & 3/4" Trade Size	Die-Cast Zinc	Carpet	Included with Box
<b>AC Series AC8104</b>	Square	Dual	4 Gangs	Steel	1 5/8" [41mm]	1/2" & 3/4" Trade Size	Die-Cast Zinc	Carpet	Included with Box
<b>AC Series AC8105</b>	Square	Triple	6 Gangs	Steel	2" [51mm]	1/2" & 3/4" Trade Size	Die-Cast Zinc	Carpet	Included with Box
<b>AC Series AC10105</b>	Square	Triple	8 Gangs	Steel	2" [51mm]	1/2" & 3/4" Trade Size	Die-Cast Zinc	Carpet	Included with Box

**NOTE: Most Wiremold floor boxes and accessories are listed by Underwriters Laboratories Inc., and comply with Federal Specifications W-C-583b in one of the following types and classes: Type I-Fully adjustable, Type II-Semi-adjustable, Type III-Non-adjustable, Class 1-Watertight, Class 2-Concrete-tight.**

## 862 SERIES™ FLOOR BOXES



862 Series™ Residential Floor Boxes provide an excellent solution for low density power or communication requirements for both concrete or wood floor applications.

## CODE REFERENCE

cULus Listed  
**Nonmetallic Outlet Boxes:**  
 File E110748 Guide QCMZ.  
 Meets Article 314.27(C) of NEC.

## 862 Series Floor Box Kits Ordering Information

## Knockouts:

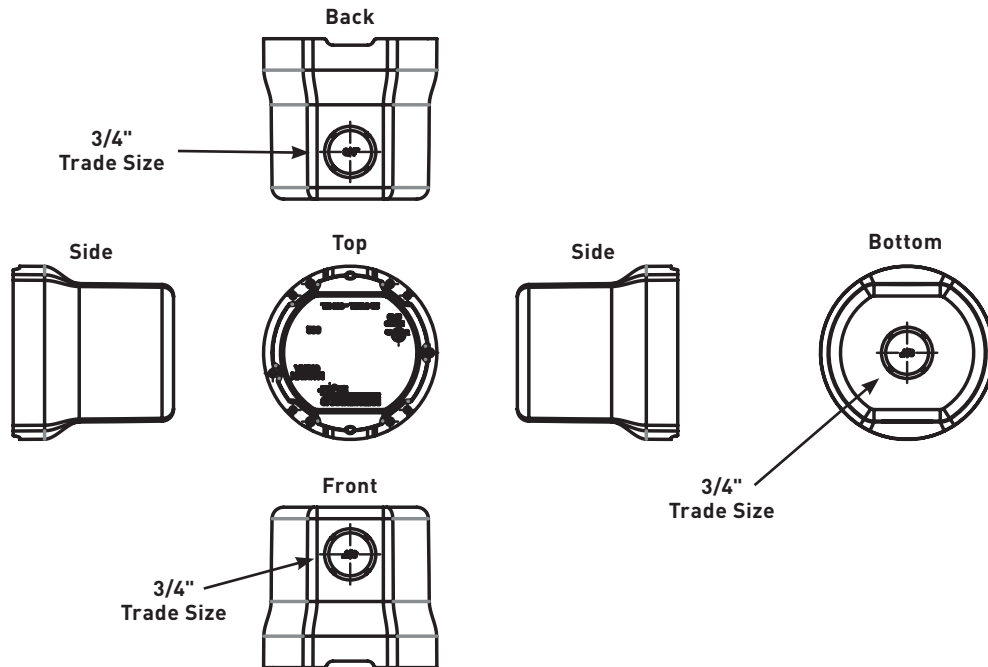

## COLOR OPTIONS



862 Series™ Floor Box Kits are available in these colors as indicated in the part number descriptions.

**Custom color options are also available. Consult the factory for more information.**

# 862 SERIES™ FLOOR BOXES

## 862 Series Floor Box Kits Ordering Information (continued)

### 862 PVC Floor Box

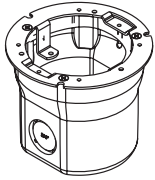

Box only, for wood or concrete floors. When using in concrete floor, order 862KIT with 862 Floor Box.

### 862KIT Concrete Floor Kit

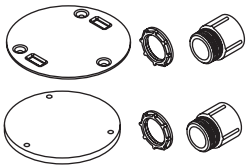

When using any of the 862 Series Floor Boxes in a concrete floor, the 862KIT will provide a mud cap for the concrete pour, two 3/4" trade size conduit hubs, and a scrub water gasket. Not needed for wood floor installations.

### 862DB PVC Floor Box Assembly For Wood or Concrete Floors

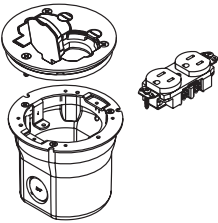

Includes 862 Series Floor Box, one 15A, 125V tamper-resistant brown duplex receptacle, and one 895T brass duplex receptacle cover for tile. Order 862KIT when using in concrete floor.

### 862C PVC Floor Box Assembly For Wood or Concrete Floors

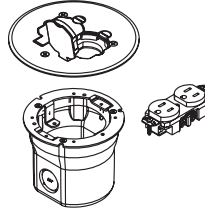

Includes 862 Series Floor Box, one 15A, 125V tamper-resistant brown duplex receptacle, and one 895 brass duplex receptacle cover for carpet. Order 862KIT when using in concrete floor.

### 862GFI PVC Floor Box Assembly For wood or Concrete floors

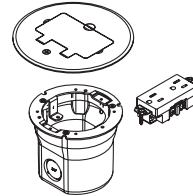

Includes 862 Series Floor Box, one Decorator style 15A, 125V tamper-resistant brown receptacle, and one 895GFI brass cover for carpet. Order 862KIT when using in concrete floor.

### 862TGFI PVC Floor Box Assembly For Wood or Concrete Floors

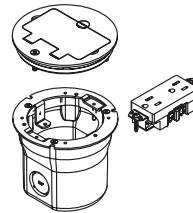

Includes 862 Series Floor Box, one Decorator style 15A, 125V tamper-resistant brown receptacle, and one 895TGFI brass cover for tile. Order 862KIT when using in concrete floor.