

rotary switches

reliable switching to 100A



M

Rotary Switches



Moeller series rotary switches are an economic choice for the simple logic functions and manual switching required in many industrial applications. From simple ON-OFF disconnects, to reversing wye-delta motor control, Moeller series rotary switches offer an array of standard and custom switches to precisely match your functional requirements.

Switching to your application

Moeller series rotary switches contain two switch lines, each with two frame sizes, that can handle loads to 100A or 75HP @ 575V. As with other world class Moeller series products, you can expect the highest level of reliability from these devices.

The "T" rotary switch line is highly versatile, allowing for many configuration options such as step load switching, control switching and specialty selectors.

The "P" motor disconnect line has a robust amp and horsepower capacity, with optional built-in auxiliary contacts in our standard selection.

Red handles and yellow faceplate options are available, allowing for approved emergency-stop switches in all product lines and frame sizes.

Versatile switching, versatile mounting

All switches are available in multiple mounting types including traditional flush and base mounting. Many switches are also available with center hole mounting as well as pre-mounted in an NEMA 3R (IP65) enclosure. Multiple mounting options provide application flexibility so you can build the switch to fit your machine instead of the other way around.

> Single phase and three phase switches

> Up to 100A / 75HP (@ 575V)

> Custom switches available with quick turnaround

> Keyed and non-keyed switches

Flush Mounting

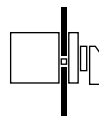

Suitable for panel or machine mounting

Base Mounting

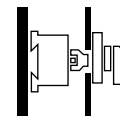

Designed for through-the-door mounting of enclosed systems

Center Hole Mounting

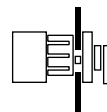

Switch is mounted in panel or machine with standard 22.5 mm hole (same as pilot devices)

Enclosed

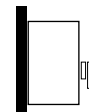

Switch is self-enclosed in insulated plastic enclosure. Rated to NEMA 1, 12 & 3R and IP65.





Offering the right stuff

Various handle types, shrouds, shaft extensions, neutral terminals and keyed operator accessories are available to round out the line, making it easy to use the right stuff for your application.



Approved for export or domestic use

Along with UL / CSA approvals, rotary switches are also approved for export with IEC and VDE. In addition, all enclosed rotary switches can be ordered with ATEX approvals (for explosive atmospheres). See page M40 for ATEX information.







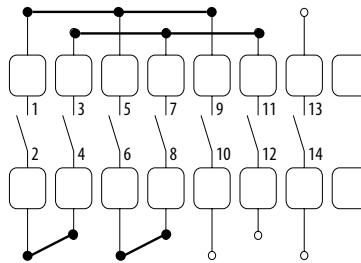

Designed by the right person – YOU!

The nature of rotary switches allows for many different configurable combinations. We maintain a custom rotary switch facility in North America where contact design and behavior can be configured to your exact specifications within a week. Custom faceplates are engraved on location with a quick turnaround. Even master key systems are available. Sales representatives are always ready to assist in designing the switch you need... fast!





Custom rotary switch options include engraved faceplates, master key systems, and contact behavior configurations (illustrated left).

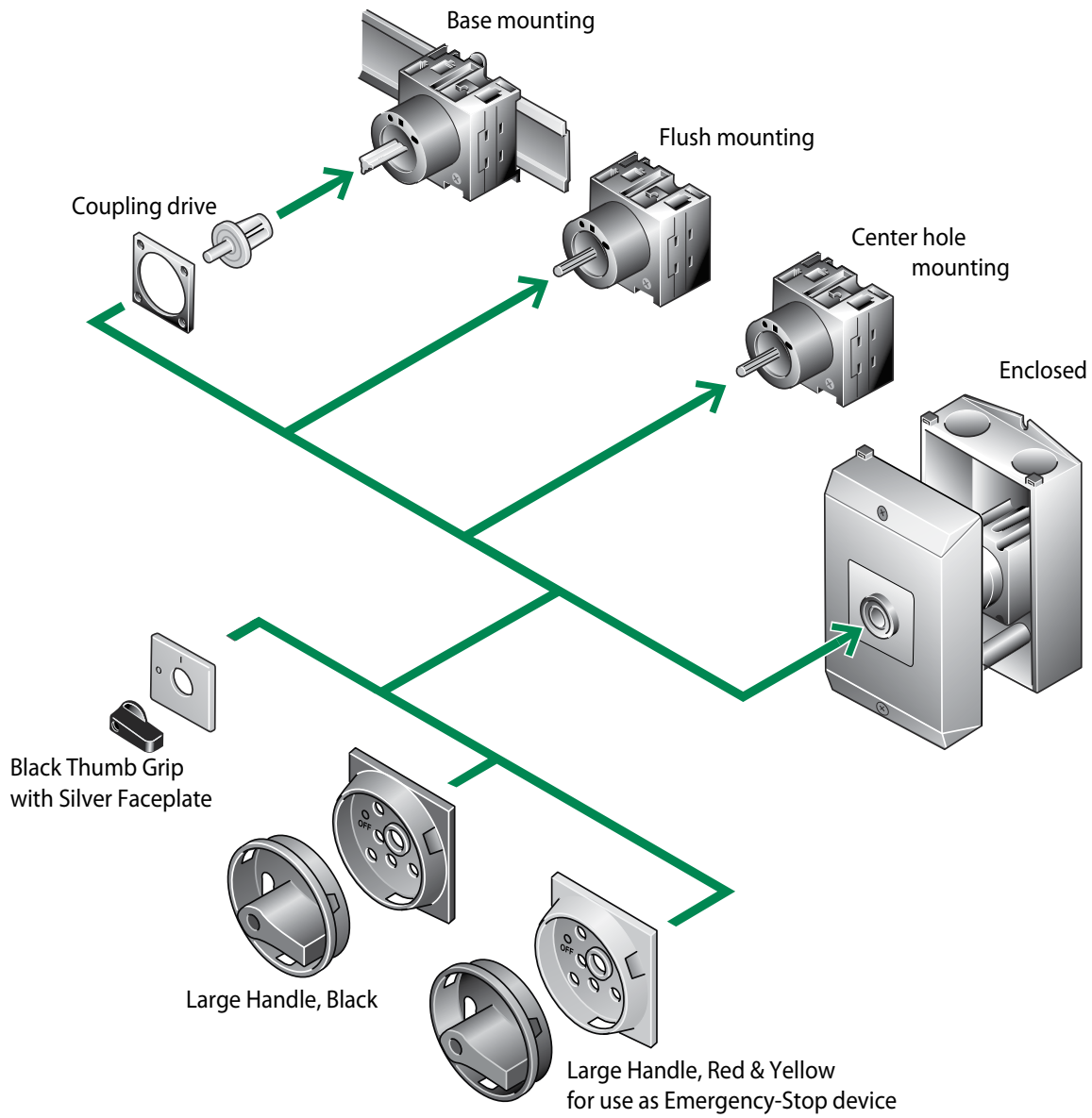

Feature Comparison

Rotary Switch Series		Amperes	Flush Mounting	Base Mounting	Center Hole Mounting	Enclosed	Customizable	Maximum Chambers	Max Chambers when enclosed	Single Phase (page XX)	Three Phase (page XX)	Control Switches (page XX)	Specialty Switches (page XX)
P Series Rotary Disconnect Switches													
P	Small Frame Size	P1-25...  20 Amps	✓	✓	✓	✓				✓	✓		
		P1-32...  30 Amps	✓	✓	✓	✓				✓	✓		
	Large Frame Size	P3-63...  60 Amps	✓	✓		✓				✓	✓		
		P3-100...  100 Amps	✓	✓		✓				✓	✓		
T Series Rotary Cam Switches													
T	Small Frame Size	T0...  16 Amps	✓	✓	✓	✓	✓	11	4	✓	✓	✓	✓
		T3...  25 Amps	✓	✓	✓	✓	✓	11	5	✓	✓	✓	✓
	Large Frame Size	T5B...  65 Amps	✓	✓		✓	✓	10	4	✓	✓	✓	✓



Rotary Switches Overview

Device	Description	Range	Pages
Rotary Switches			
	Single Phase Switches Motor Disconnect On-Off Emergency-Stop Changeover Reversing	Up to 15 HP @230V; Up to 100 Amps	M10 – M15
	Three Phase Switches Motor Disconnect On-Off Emergency-Stop Changeover Reversing Star-Delta Multi-Speed	Up to 75 HP @575V; Up to 100 Amps	M16 – M25
	Control Switches Step (2 – 6 steps) On-Off Hand-Auto On (make contact) Changeover Series		M26 – M32
	Specialty Switches Multi-purpose Coding Voltmeter Ammeter Voltmeter & Ammeter		M33 – M35
Accessories			
	Handles Keyed Operators Terminals Extensions Shrouds		M36 – M39

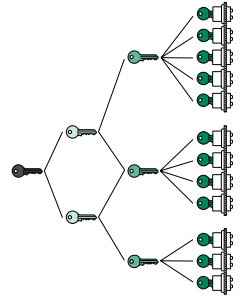
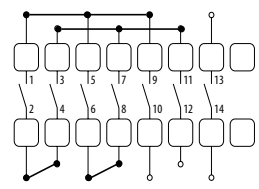
Device	Description	Pages
Enclosures		
	Enclosures	M40
Faceplates		
	Alternate faceplates Blank faceplates Custom engraved faceplates	M41 – M52
Master Key System		
	Master key system for keyed operators	M53 – M58
Custom Switches		
	Custom rotary switches	M59 – M65

M
Rotary Switches

The Moeller series catalog numbering system for rotary switches and other devices follows a logical system. Device attributes can be determined by the following nomenclature.

Dashes (–) and slashes (/) are used to separate device attributes and should always be included when ordering.

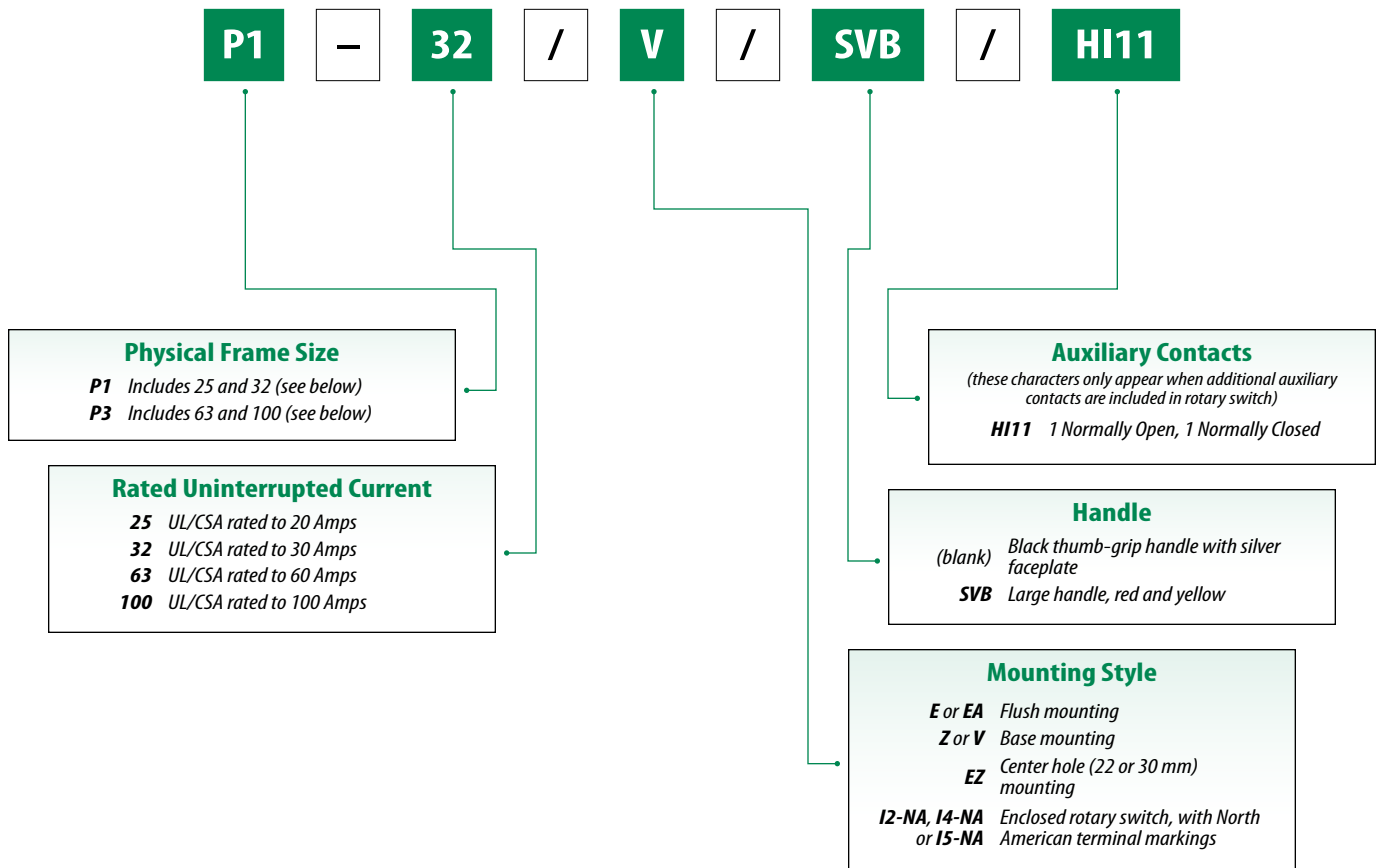

This page for reference only.
 Please turn to the appropriate pages to determine
 the exact device and/or accessories required for your application.

Single Phase Switches ①

No. of Poles	Standard Faceplate (for other options, note faceplate code and frame size of desired switch and turn to page M41.)	Contact Sequence	Rated for Applications	Built-in Auxiliary Contacts		Single Phase Max. Motor Rating [HP]			Current Rating UL/CSA	Handle						
				NO	NC	@115V	@200V	@230V								
ON-OFF Switches																
1			Motor Disconnect Switch On-Off Switch Emergency-Stop ②	0	0	¾	2	2	16	Black / Silver Padlockable - Red / Yellow						
						1½	3	3	25	Black / Silver Padlockable - Red / Yellow						
						3	7½	10	65	Black / Silver Padlockable - Red / Yellow						
2	Black / Silver handles: FS 908		Motor Disconnect Switch On-Off Switch Emergency-Stop ②	0	0	¾	2	2	16	Black / Silver Padlockable - Red / Yellow						
						1½	3	3	25	Black / Silver Padlockable - Red / Yellow						
						3	7½	10	65	Black / Silver Padlockable - Red / Yellow						
3	Padlockable handles are not supplied with faceplate. Padlockable handles are marked: I ON O OFF		On-Off Switch Emergency-Stop ②	0	0	¾	2	2	16	Black / Silver Padlockable - Red / Yellow						
			These switches can also be used in three phase applications. See page M16 for ratings.													
			Motor Disconnect Switch On-Off Switch Emergency-Stop ②							0	0	1½	3	3	20	Black / Silver Padlockable - Red / Yellow
			These switches can also be used in three phase applications. See page M16 for ratings.									2	3	5	30	Black / Silver Padlockable - Red / Yellow
3	7½	10	60	Black / Silver Padlockable - Red / Yellow												
5	10	15	100	Black / Silver Padlockable - Red / Yellow												

Custom switch configurations available - see page M59 for details.

- ① Non-enclosed switches are supplied with European terminal markings (1, 3, 5, etc.). For North American terminal markings (L1, L2, L3, etc.), add suffix -NA to catalog number and add \$25 to price. Enclosed switches have North American terminal markings as standard.
- ② Choose Red / Yellow or Padlockable - Red / Yellow handle for Emergency-stop applications.

Ordering Instructions

- 1 Locate the desired rotary switch.
- 2 Order accessories separately on pages M36 – M40.

Standard Handle Types

Black / Silver	Padlockable - Red / Yellow
Black handle Silver faceplate NEMA 1	Red/Yellow handle, NEMA 3R Padlockable in OFF position Suitable for emergency-stop applications

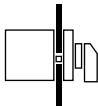
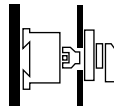
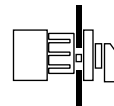
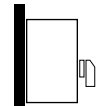
Flush Mounting		Base Mounting		Center Hole (22.5 / 30 mm) Mounting		Enclosed NEMA 12, 3R (IP65) Insulated Plastic	
							
Catalog Number	Price	Catalog Number	Price	Catalog Number	Price	Catalog Number	Price
ON-OFF Switches							
T0-1-8200/E		T0-1-8200/Z		T0-1-8200/EZ		T0-1-8200/I2-NA	
T0-1-8200/EA/SVB		T0-1-8200/V/SVB		–		T0-1-8200/I2/SVB-NA	
T3-1-8200/E		T3-1-8200/Z		T3-1-8200/EZ		T3-1-8200/I2-NA	
T3-1-8200/EA/SVB		T3-1-8200/V/SVB		–		T3-1-8200/I2/SVB-NA	
T5B-1-8200/E		T5B-1-8200/Z		–		T5B-1-8200/I4-NA	
T5B-1-8200/EA/SVB		T5B-1-8200/V/SVB		–		T5B-1-8200/I4/SVB-NA	
T0-1-102/E		T0-1-102/Z		T0-1-102/EZ		T0-1-102/I2-NA	
T0-1-102/EA/SVB		T0-1-102/V/SVB		–		T0-1-102/I2/SVB-NA	
T3-1-102/E		T3-1-102/Z		T3-1-102/EZ		T3-1-102/I2-NA	
T3-1-102/EA/SVB		T3-1-102/V/SVB		–		T3-1-102/I2/SVB-NA	
T5B-1-102/E		T5B-1-102/Z		–		T5B-1-102/I4-NA	
T5B-1-102/EA/SVB		T5B-1-102/V/SVB		–		T5B-1-102/I4/SVB-NA	
T0-2-1/E		T0-2-1/Z		T0-2-1/EZ		T0-2-1/I2-NA	
T0-2-1/EA/SVB		T0-2-1/V/SVB		–		T0-2-1/I2/SVB-NA	
P1-25/E		P1-25/Z		P1-25/EZ		P1-25/I2-NA	
P1-25/EA/SVB		P1-25/V/SVB		–		P1-25/I2/SVB-NA	
P1-32/E		P1-32/Z		P1-32/EZ		P1-32/I2-NA	
P1-32/EA/SVB		P1-32/V/SVB		–		P1-32/I2/SVB-NA	
P3-63/E		P3-63/Z		–		P3-63/I4-NA	
P3-63/EA/SVB		P3-63/V/SVB		–		P3-63/I4/SVB-NA	
P3-100/E		P3-100/Z		–		P3-100/I5-NA	
P3-100/EA/SVB		P3-100/V/SVB		–		P3-100/I5/SVB-NA	

Optional Handles - Order Separately (see page M36 for details and other options)

For Switch Frames	Options for Black / Silver handles										Options for Padlockable - Red / Yellow handles	
	Red Handle / Yellow Faceplate				Cylinder Lock: Key operated Silver faceplate		Cylinder Lock: Black handle Silver faceplate		Padlock Mechanism: Black handle Silver faceplate		Padlockable Black Handle	
	Handle		Faceplate		Not UL/CSA approved		Not UL/CSA approved		Not UL/CSA approved		NEMA 3R	
	Catalog No.	Price	Catalog No.	Price	Catalog No.	Price	Catalog No.	Price	Catalog No.	Price	Catalog No.	Price
T0, T3, P1	KNB-RT-T0		FS908GE-T0		S-T0		SVA-T3		SVC-T3		SVB-SW-T0	
T5B, P3	KNB-RT-P3		FS908GE-P3		–		–		–		SVB-SW-P3	

Rotary Switches			P1-25...	P1-32...	P3-63...	P3-100...	
General							
Standards			IEC/EN 60947, VDE 0660, IEC/EN 60204, CSA, UL Switch-disconnectors to IEC/EN 60947-3				
UL report number			E36332				
CSA report number			012528				
Lifespan, mechanical	Operations	[x 10 ⁶]	0.3	0.3	0.1	0.1	
Maximum operating frequency	Operations/h		50	50	50	50	
Climatic proofing			Damp heat, constant, to IEC 60068-2-78; Damp heat, cyclical, to IEC 60068-2-30				
Ambient temperature							
Open		[°C / °F]	-25...50 °C / -13...122 °F	-25...50 °C / -13...122 °F	-25...50 °C / -13...122 °F	-25...50 °C / -13...122 °F	
Enclosed		[°C / °F]	-25...40 °C / -13...104 °F	-25...40 °C / -13...104 °F	-25...40 °C / -13...104 °F	-25...40 °C / -13...104 °F	
Mounting position			As required				
Mechanical shock-resistance (IEC/EN 60068-2-27)							
Half-sinusoidal shock, 20 ms			[g]	15	15	15	15
Contacts							
Rated operational voltage	U_e	[V AC]	690	690	690	690	
Rated impulse withstand voltage	U_{imp}	[V AC]	6000	6000	6000	6000	
Overvoltage category/pollution degree			III/3				
Rated uninterrupted current (UL)	I_u	[A]	25	32	63	100	
Load rating with intermittent operation, class 12							
AB 60 % DF		[x I_e]	1.3	1.3	1.3	1.3	
AB 40 % DF		[x I_e]	1.6	1.6	1.6	1.6	
AB 25 % DF		[x I_e]	2	2	2	2	
Short-circuit rating	Fuse	[A gG/gL]	25	50	80	100	
Rated short-time withstand current (1 s current)	I_{cw}	[A _{rms}]	640	640	1260	2000	
Isolating characteristics to IEC/EN 60947			[V AC] 690				
Safe isolation to VDE 0106 Part 101 and Part 101/A1							
Between auxiliary contacts and main contacts			[V AC] 440				
Switching angles			[°] 90				
Contact units			max. 3(+N)				
Current heat loss per contact at I_e			[W] 1.1, 1.8, 4.5, 7.5				
Terminal Capacities							
Solid or stranded			[mm ²]				
			1 x (1.5 – 6)				
			2 x (1.5 – 6)				
Flexible with ferrule to DIN 46228			[mm ²]				
			1 x (1 – 4)				
			2 x (1 – 4)				
			1 x (1.5 – 25)				
			2 x (1.5 – 6)				
Terminal screw			M4, M5				
Tightening torque			[Nm] 1.6, 3				

Rotary Switches				P1-25...	P1-32...	P3-63...	P3-100...
Switching Capacity (IEC only)							
AC							
Rated making capacity $\cos \varphi = 0.35$		[A]		240	320	800	950
Rated breaking capacity, motor load switch $\cos \varphi = 0.35$							
230V		[A]		190	260	640	760
400V		[A]		150	300	640	740
500V		[A]		170	290	590	880
690V		[A]		150	250	340	520
AC-21A Rated operational current load-break switch							
440V	I_e	[kW]		25	32	63	100
AC-3 motor load switch motor rating							
230V	P	[kW]		5.5	7.5	15	22
400/415V	P	[kW]		7.5	13	30	37
500V	P	[kW]		7.5	18.5	30	45
690V	P	[kW]		7.5	15	30	37
AC-23A motor load switches (main switches, maintenance switches)							
230V	P	[kW]		7	8.5	18.5	45
400/415V	P	[kW]		13	15	37	37
500V	P	[kW]		11	18.5	37	30
690V	P	[kW]		11	18.5	30	50
DC							
DC-1, load-break switches L/R = 1 ms							
Rated operational current		I_e	[A]	25	32	63	65
Voltage per contact pair in series			[V]	60	60	60	45
DC-23A, motor load switch L/R = 15 ms							
24V	Rated operational current	I_e	[A]	25	25	50	100
	Contacts		[Quantity]	1	1	1	60
48V	Rated operational current	I_e	[A]	25	25	50	50
	Contacts		[Quantity]	2	2	2	1
60V	Rated operational current	I_e	[A]	25	25	50	50
	Contacts		[Quantity]	3	3	3	3
120V	Rated operational current	I_e	[A]	12	12	25	25
	Contacts		[Quantity]	3	3	3	3

M

Rotary Switches

**P1-... Rotary Switches
Enclosed**

Standard size handle
P1-.../I2

Dimensions are in millimeters.
Not intended for manufacturing purposes.

M
Rotary Switches

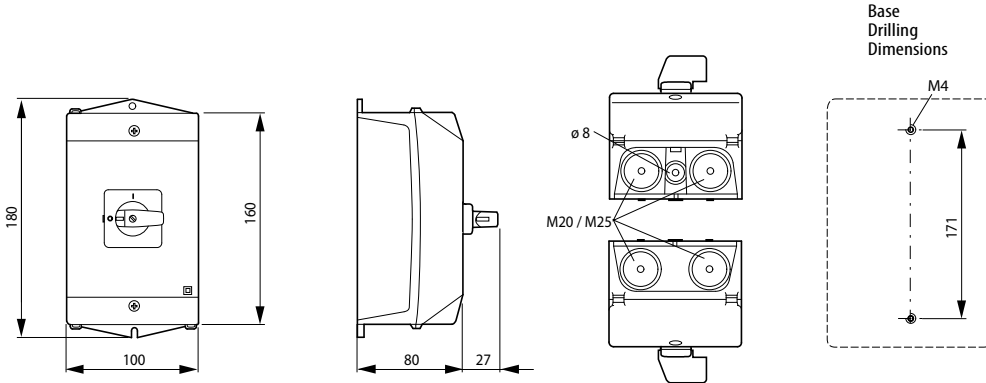

Padlockable size handle
P1-.../I2/SVB-SW
P1-.../I2/SVB

