











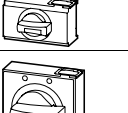

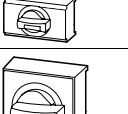

	For use with	Part no. Article no. when ordered separately	Price see price list	Std. pack	Notes
Rotary handles					
Complete with rotary drive					
Standard, black/grey					
	NKM1(-4), PN1(-4), N1(-4)	NKM1-XD 260116		1 off	NKM1, 2, 3: Can also be combined with insulating surround.
	NKM2(-4), PN2(-4), N2(-4)	NKM2-XD 260121			
	NKM3(-4), PN3(-4), N3(-4)	NKM3-XD 260123			
	NKM4(-4), N4(-4)	NKM4-XD 266606			
	Lockable on the 0 position on the switch using up to 3 padlocks.	NKM1(-4), PN1(-4), N1(-4)	NKM1-XDV 260125		NKM1, 2, 3: Can also be combined with insulating surround. MODAN handle position detection by wire release can be retrofitted.
		NKM2(-4), PN2(-4), N2(-4)	NKM2-XDV 260127		
		NKM3(-4), PN3(-4), N3(-4)	NKM3-XDV 260129		
		NKM4(-4), N4(-4)	NKM4-XDV 266608		
	Lockable on the 0 position on the handle using up to 3 padlocks.	NKM1(-4), PN1(-4), N1(-4)	NKM1-XDVG 285247		Can also be combined with insulating surround.
		NKM2(-4), PN2(-4), N2(-4)	NKM2-XDVG 285248		
Red-yellow for Emergency-Stop					
	Lockable on the 0 position on the switch using up to 3 padlocks.	NKM1(-4), PN1(-4), N1(-4)	NKM1-XDVR 260135	1 off	NKM1, 2, 3: Can also be combined with insulating surround. MODAN handle position detection by wire release can be retrofitted.
		NKM2(-4), PN2(-4), N2(-4)	NKM2-XDVR 260137		
		NKM3(-4), PN3(-4), N3(-4)	NKM3-XDVR 260140		
		NKM4(-4), N4(-4)	NKM4-XDVR 266610		
	Lockable on the 0 position on the handle using up to 3 padlocks.	NKM1(-4), PN1(-4), N1(-4)	NKM1-XDVGR 285249		Can also be combined with insulating surround.
		NKM2(-4), PN2(-4), N2(-4)	NKM2-XDVGR 285280		

Notes

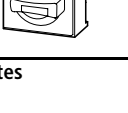
Circuit-breaker can also be installed in a lying position 90° left/right, with the handle still in the same position.

Rotary handle on circuit-breaker

NZM3-XD

NZM3-XDV(R)

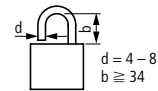
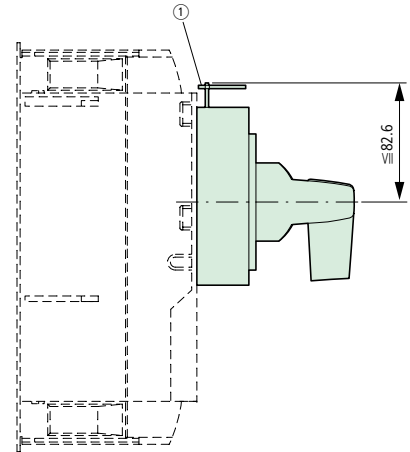
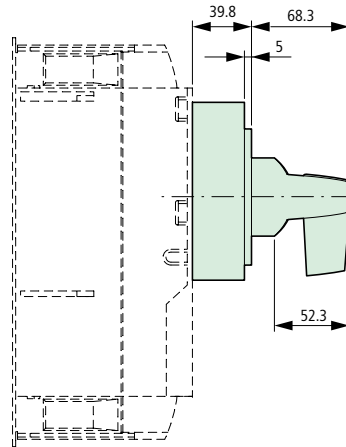
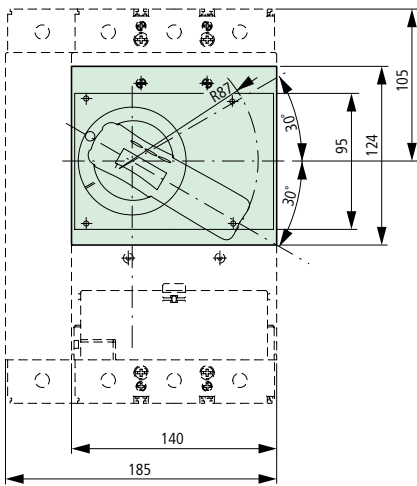

① Up to 3 padlocks

Door coupling rotary handle

NZM3-XT(V)D(V)(R)

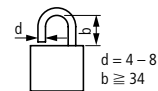
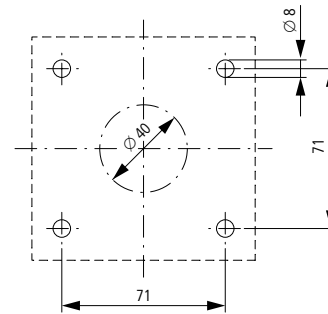
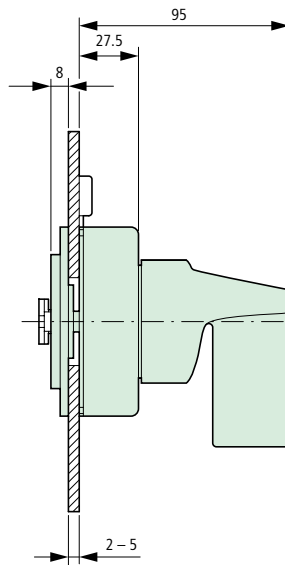
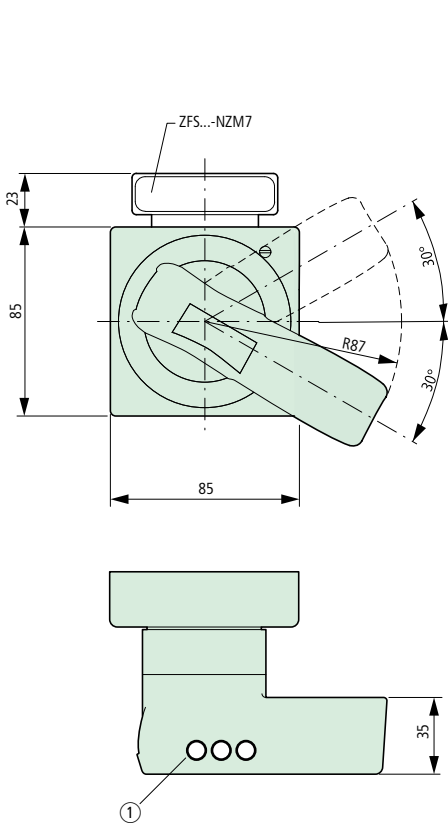

① Up to 3 padlocks