

Type 4X Stainless Steel Junction Box *Eclipse Junior Series*

Continuous Hinge Door with Quarter Turn



Application

- Designed for use as instrument enclosures, electric, hydraulic or pneumatic control housings, electrical junction boxes or terminal wiring enclosures.
- Provides protection where equipment may be hosed down or otherwise be very wet, or in specific applications where corrosion may be a problem.
- For high temperature applications, a gasket retainer may be required, please refer to factory.

Standards

- UL 508 Type 3R, 4, 4X, 12, and 13
- CSA Type 3R, 4, 4X, 12, and 13
- Complies with
 - NEMA Type 3R, 4, 4X, 12 and 13
 - JIC EGP-1-1967
 - IEC 60529, IP66

Construction

- Body and cover are formed from 16 gauge 304 or 316 stainless steel.
- Smooth, continuously welded seams without knockouts, cutouts, or holes.
- Formed lip on enclosure to exclude flowing liquids and contaminants.
- 14 gauge welded brackets provide for enclosure mounting.
- Continuously hinged cover has stainless steel hinges and provides 180° opening.
- Door latches feature the added safety of quarter turn slot requiring use of tool for opening.
- Quarter turn latches formed from 316 stainless steel.
- Seamless poured-in place gasket.
- Models larger than 4"x4" include a removable 14 gauge galvanized inner panel.
- Tapped studs are provided for mounting inner panels.
- A bonding stud is provided on the door and a grounding stud is provided on the enclosure.
- Grounding and panel mounting hardware provided.

Finish

- Cover and enclosure are natural stainless steel with a smooth brushed finish.
- Removable inner panel is unpainted galvanized steel.

Accessories

- Inner Panels
- Filtered Fans
- Ventilation
- Type 1 Louvered Ventilating Plates

- Padlock Adaptor
- Temperature Controls

- Terminal Kit Assemblies
- Window Kits

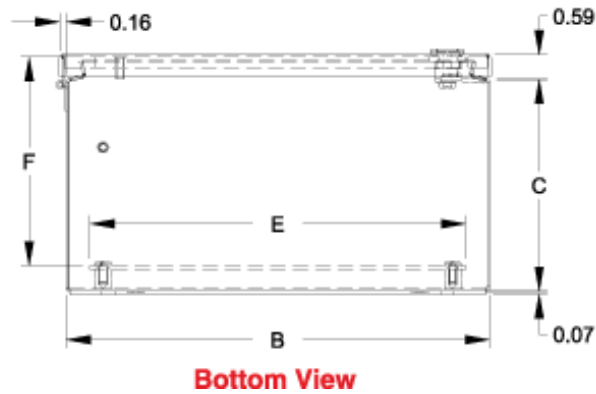
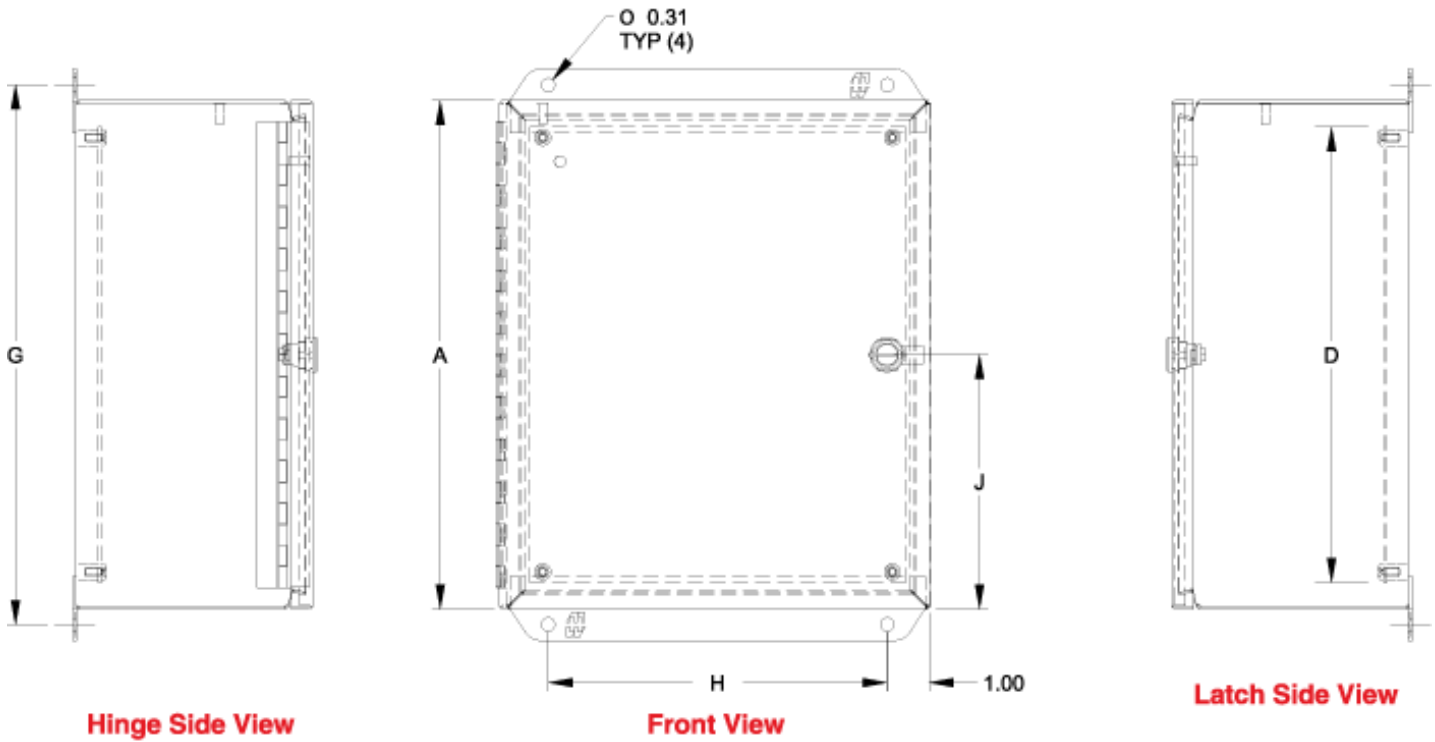

304 S.S. Part No.	316 S.S. Part No.	Overall Dimensions			Panel Size		F	G	H	J	Ship Wt. lbs
		A	B	C	D	E					
EJ443SS	EJ443S16	4.00	4.00	3.00	N/A	N/A	2.92	4.75	2.00	2.00	2
EJ444SS	EJ444S16	4.00	4.00	4.00	N/A	N/A	4.00	4.75	2.00		2
EJ643SS	EJ643S16	6.00	4.00	3.00	4.88	2.88	2.92	6.75	2.00	3.00	2
EJ863SS	EJ863S16	8.00	6.00	3.50	6.75	4.88	3.42	8.75	4.00	4.00	5
EJ644SS	EJ644S16	6.00	4.00	4.00	4.88	2.88	3.92	6.75	2.00	3.00	3
EJ664SS	EJ664S16	6.00	6.00	4.00	4.88	4.88	3.92	6.75	4.00	3.00	4
EJ884SS	EJ884S16	8.00	8.00	4.00	6.75	6.88	3.92	8.75	6.00	4.00	7
EJ1084SS	EJ1084S16	10.00	8.00	4.00	8.75	6.88	3.92	10.75	6.00	5.00	8
EJ1264SS	EJ1264S16	12.00	6.00	4.00	10.75	4.88	3.92	12.75	4.00	6.00	8
EJ12124SS	EJ12124S16	12.00	12.00	4.00	10.75	10.90	4.00	12.80	10.00		12
EJ12105SS	EJ12105S16	12.00	10.00	5.00	10.75	8.88	4.92	12.75	8.00	6.00	12
EJ866SS	EJ866S16	8.00	6.00	6.00	6.75	4.88	5.92	8.75	4.00	4.00	7
EJ1086SS	EJ1086S16	10.00	8.00	6.00	8.75	6.88	5.92	10.75	6.00	5.00	10
EJ10106SS	EJ10106S16	10.00	10.00	6.00	8.75	8.88	5.92	10.75	8.00	5.00	12
EJ12106SS	EJ12106S16	12.00	10.00	6.00	10.75	8.88	5.92	12.75	8.00	6.00	12

304 S.S. Part No.	316 S.S. Part No.	Overall Dimensions			Panel Size						Ship Wt.
		A	B	C	D	E	F	G	H	J	lbs
EJ12126SS	EJ12126S16	12.00	12.00	6.00	10.75	10.88	5.92	12.75	10.00	6.00	15
EJ14126SS	EJ14126S16	14.00	12.00	6.00	12.75	10.88	5.92	14.75	10.00	7.00	17
EJ16146SS	EJ16146S16	16.00	14.00	6.00	14.75	12.88	5.92	16.75	12.00	8.00	21
EJ12108SS	EJ12108S16	12.00	10.00	8.00	10.75	8.88	7.92	12.75	8.00	6.00	15
EJ14128SS	EJ14128S16	14.00	12.00	8.00	12.75	10.88	7.92	14.75	10.00	7.00	18
EJ16148SS	EJ16148S16	16.00	14.00	8.00	14.75	12.88	7.92	16.75	12.00	8.00	22
EJ161410SS	EJ161410S16	16.00	14.00	10.00	14.75	12.88	9.92	16.75	12.00	8.00	23

Data subject to change without notice

© 2016. Hammond Manufacturing Ltd. All rights reserved.