

ECLIPSE™ SERIES RACEWAYS

Single Channel



One-piece, latching, single-channel raceway available in three profiles. Easy-to-install and ideal for demanding communication designs. Accommodates communication or power wiring.

CODE REFERENCE

cULus Listed Raceway:
File E90378 Guide RJTX.
Complies with flammability requirements of UL-5A.

Fittings:
File E90377 Guide RJYT.
Meets Article 388 of NEC.
UL Listed for up to 600V.
Meets Section 12-1600 of CEC.

Eclipse Series PN03, PN05, PN10 Raceways System Layout

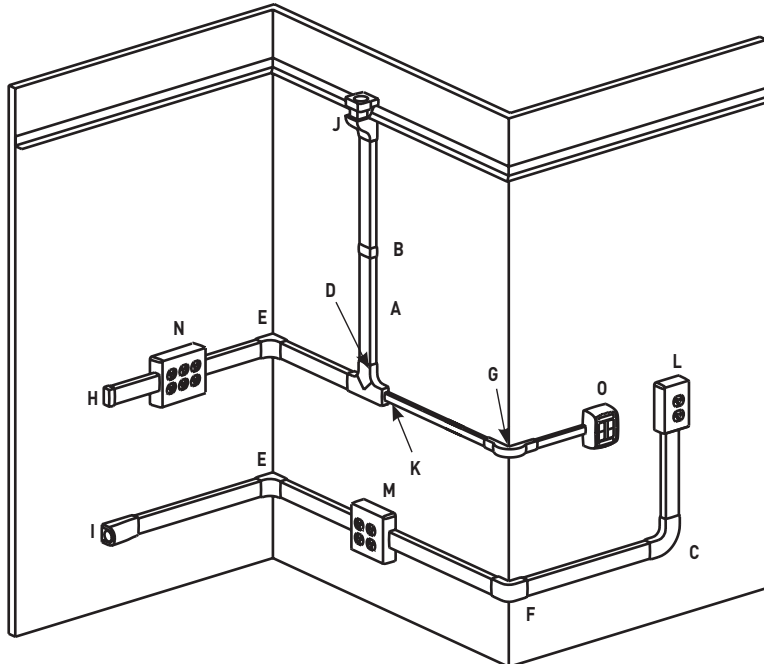

NOTE: Illustration is for showing product applications only.

KEY

- A. PN03L08, PN03L10, PN05L08, PN05L10, PN10L08, PN10L10 Latching Raceway
- B. PN03F06, PN05F06, PN10F06 Cover Clip
- C. PN03F11, PN05F11, PN10F11 90° Flat Elbow Fitting
- D. PN03F15, PN05F15, PN10F15 Tee Fitting
- E. PN03F17, PN05F17, PN10F17 Internal Elbow Fitting
- F. PN03F18, PN05F18, PN10F18 External Elbow Fitting
- G. PN03F19, PN05F19, PN10F19 Bend Radius External Elbow Fitting
- H. PN03F20, PN05F20, PN10F20 Blank End Fitting
- I. PN10F21 Entrance End Fitting
- J. PN05F86, PN10F86 Drop Ceiling Connector
- K. PN153R Reducer Adapter
- L. PSB1 One-Gang Device Box
- M. PSB2 Two-Gang Device Box
- N. PSB3 Three-Gang Device Box
- O. PBB2S2, PBB4TJ, PDB1CM, PDB1S2, PDB2CM, PDB2S2, PDB4TJ Communication Box

COLOR OPTIONS



Eclipse™ Series Raceway Part Numbers with a "-WH" suffix have a white finish. Part Numbers with a "-FW" suffix have a fog white finish. Part Numbers with a "-V" suffix have an ivory finish. Eclipse Series Raceways are paintable using latex paint.

ECLIPSE™ SERIES RACEWAYS

Ordering Information

PSB1 One-Gang Device Box

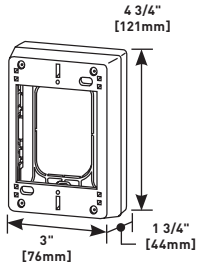

Accepts all standard single-gang NEMA faceplates and keystone jacks. Twistouts on all four sides for PN03, PN05, and PN10 Series Raceways. Designed for use with Ortronics® WiJack™ Wireless Access Point. Available in fog white (PSB1-FW), white (PSB1-WH), and ivory (PSB1-V).

PDB1CM CM Data Box

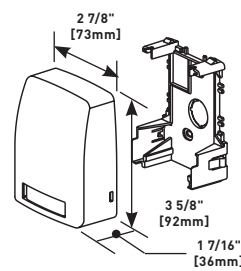

Surface mount box for use with Eclipse Raceway or standalone application. Has one 1/2" trade size KO. Accepts one front-loaded downward facing Pass & Seymour® Activate or Wiremold® Open System communication module. Available in fog white (PDB1CM-FW), white (PDB1CM-WH), and ivory (PDB1CM-V).

PSB2 Two-Gang Device Box

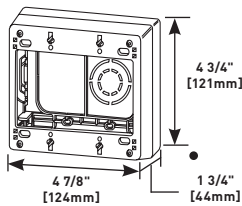

Accepts all standard two-gang NEMA faceplates and keystone jacks. Twistouts on all four sides for PN03, PN05, and PN10 Series Raceways. Has 1/2" and 3/4" concentric trade size KOs, as well as rectangular KO for wall box mounting. Designed for use with Ortronics® WiJack™ Wireless Access Point. Available in fog white (PSB2-FW), white (PSB2-WH), and ivory (PSB2-V).

PDB2S2 Series II Data Box

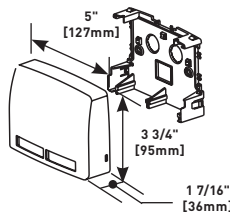

Surface mount box for use with Eclipse Raceway or standalone application. Has two 1/2" trade size KOs. Accepts two front-loaded downward facing Ortronics® Series II inserts. Available in fog white (PDB2S2-FW), white (PDB2S2-WH), and ivory (PDB2S2-V).

PSB3 Three-Gang Device Box

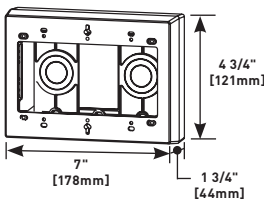

Accepts all standard three-gang NEMA faceplates and keystone jacks. Twistouts on all four sides for PN03, PN05, and PN10 Series Raceways. Has 1/2" and 3/4" concentric trade size KOs. Designed for use with Ortronics® WiJack™ Wireless Access Point. Available in fog white (PSB3-FW), white (PSB3-WH), and ivory (PSB3-V).

PDB2CM CM Data Box

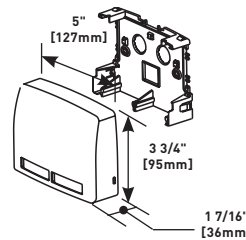

Surface mount box for use with Eclipse Raceway or standalone application. Has two 1/2" trade size KOs. Accepts two front-loaded downward-facing Pass & Seymour® Activate or Wiremold® Open System communication modules. Available in fog white (PDB2CM-FW), white (PDB2CM-WH), and ivory (PDB2CM-V).

PDB1S2 Series II Data Box

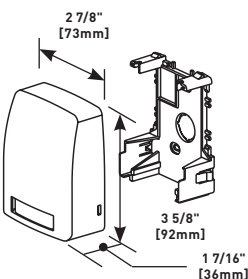

Surface mount box for use with Eclipse Raceway or standalone application. Accepts one front-loaded downward facing Ortronics® Series II insert. Available in fog white (PDB1S2-FW), white (PDB1S2-WH), and ivory (PDB1S2-V).

PDB2TJ TracJack Data Box

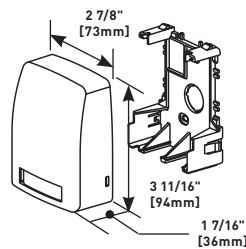

Surface mount box for use with Eclipse Raceway or standalone application. Has one 1/2" trade size KO. Accepts two front-loaded downward facing Ortronics® TracJack inserts. Available in fog white (PDB2TJ-FW), white (PDB2TJ-WH), and ivory (PDB2TJ-V).

WIREMOLD

 legrand®

ECLIPSE™

PN03, PN05, PN10 Series

Small Nonmetallic Raceway Systems

For Communications and Power Applications

Now available
in Ortronics®
Fog White!



The PN03, PN05, and PN10 Series is a family of single compartment raceways for communication or power applications. Ideal for use in classrooms, offices, and hotel applications, or anywhere a small, low profile raceway is needed. Eclipse PN03, PN05, and PN10 Raceways are specifically designed for the workstation. They accept Ortronics® Series II and TracJack® modules, Pass & Seymour Activate Series inserts, and Wiremold Open System communication modules.



Eclipse PN05A08 shown in a horizontal installation.

Features & Benefits

- **Designed for use with Ortronics TracJack and Series II modules.** A wide variety of media interface inserts to ensure a reliable, cost-effective activation for the most demanding communication system designs.
- **PSB3 Device Box accommodates wireless.** Designed for use with Ortronics® Wi-Jack™ Wireless Access Points.
- **Accommodates communication or power wiring.** Can be used for communications, computer lines, surveillance systems, fire alarms, outlets, and more.
- **Raceway available in three sizes.** PN03, PN05, and PN10 sizes provide flexibility for meeting various capacity requirements. Perfect for most small drops and horizontal runs to work stations. PN05 and PN10 are available in both latching and two-piece configurations.
- **Durable, flexible co-extruded hinge construction (on latching profiles).** Allows for repeated openings and closings while maintaining product integrity and aesthetics.
- **Snap-on latching cover.** Provides security with access to wiring for changes or additions.
- **Adhesive backing for low-voltage (under 50V) applications.** Allows base to be pressed onto surface, speeds installation.
- **Lightweight and easy to handle.** Saves time and labor costs. Standard 8' [2.44m] lengths can be easily installed by one person.
- **Built-in wire retainers.** Lay in wires easily without using wire clips. Makes installations quicker and saves both time and labor. Available on PN05A08, PN05A10, PN10A08 and PN10A10 Series.
- **Easy to align.** All base and fittings have unique alignment guides built in to help avoid unsightly gaps and uneven installations. All fitting covers have 1/4" [6.4mm] overlap to hide uneven cuts of raceway.
- **Ceiling fitting slips over suspended ceiling grid.** Saves time and labor by eliminating need to cut metal ceiling grid.
- **1" [25mm] fiber fittings.** Full capacity, aesthetically pleasing fittings provide 1" [25mm] bend radius.
- **Datacom connectivity options.** Accepts industry standard and proprietary devices from a wide range of manufacturers to provide a seamless and aesthetically pleasing communications interface at the point of use.
- **Ratings:** 600VAC, FT-4 Rated for Canada
- **Listed:**  us



Eclipse PN05L08 shown in typical vertical installations.

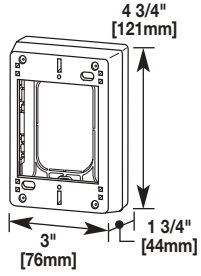
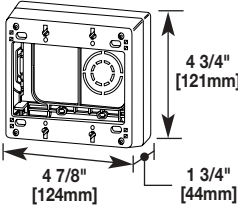
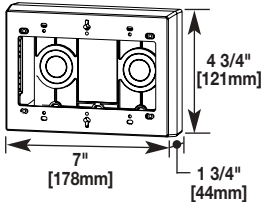

PN03, PN05, and PN10 Series Device Boxes

Catalog No./Item	Description/Specifications
<p>PSB1</p> 	<p>One-Gang Power Box – Accepts all standard single-gang NEMA faceplates. Twist-outs on all four sides for PN03, PN05, and PN10 Series Raceway.</p> <ul style="list-style-type: none"> • NEMA Faceplates • Keystone Jacks <div style="text-align: right; margin-top: 10px;"> ORT P&S OPEN </div>
<p>PSB2</p> 	<p>Two-Gang Device Box – Accepts all standard two-gang NEMA faceplates. Twist-outs on all four sides for PN03, PN05, and PN10 Series Raceway.</p> <ul style="list-style-type: none"> • NEMA Faceplates • Keystone Jacks <div style="text-align: right; margin-top: 10px;"> ORT P&S OPEN </div>
<p>PSB3</p> 	<p>Three-Gang Device Box – Accepts all standard three-gang NEMA faceplates. Twist-outs on all four sides for PN03, PN05, and PN10 Series Raceway.</p> <ul style="list-style-type: none"> • NEMA Faceplates • Keystone Jacks • Designed for use with Ortronics® Wi-Jack™ Wireless Access Points <div style="text-align: right; margin-top: 10px;"> ORT P&S OPEN </div>

NOTE: Add -“WH” suffix for White finish, -“FW” for Fog White finish or -“V” for Ivory finish.