

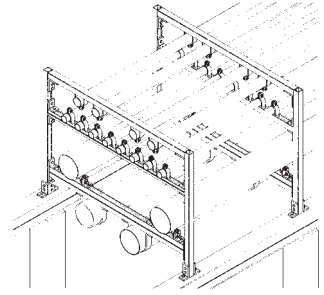







Strut Systems

The B-Line series metal framing support system is designed with many time-saving features. Fully adjustable and reusable, with a complete line of channels, fittings, and accessories for multi-purpose applications.



Strut Systems Information

SELECTION CHART for Channels, Materials and Hole Patterns

Channel	Channel Dimensions		Material & Thickness				Channel Hole Pattern				
	Height 	Width 	Steel <u>1</u>	Alum. <u>2</u>	Stainless Steel		SH 	S 	H17/8 	TH 	KO6 
					Type 304 <u>3</u>	Type 316 <u>4</u>					
B11	3 1/4" (82.5)	1 5/8" (41.3)	12 Ga.	--	--	--	<u>1</u>	<u>1</u>	<u>1</u>	--	<u>1</u>
B12	2 7/16" (61.9)	1 5/8" (41.3)	12 Ga.	.105	--	--	<u>1 2</u>	<u>1</u>	<u>1 2</u>	--	<u>1 2</u>
B22	1 5/8" (41.3)	1 5/8" (41.3)	12 Ga.	.105	12 Ga.	12 Ga.	<u>1 2 3 4</u>	<u>1</u>	<u>1 2 3 4</u>	<u>1</u>	<u>1 2</u>
B24	1 5/8" (41.3)	1 5/8" (41.3)	14 Ga.	.080	14 Ga.	14 Ga.	<u>1 2 3 4</u>	<u>1</u>	<u>1 2 3 4</u>	--	<u>1 2</u>
B26	1 5/8" (41.3)	1 5/8" (41.3)	16 Ga.	--	--	--	<u>1</u>	<u>1</u>	<u>1</u>	--	<u>1</u>
B32	1 3/8" (34.9)	1 5/8" (41.3)	12 Ga.	--	12 Ga.	--	<u>1 3</u>	<u>1</u>	<u>1 3</u>	--	<u>1</u>
B42	1" (25.4)	1 5/8" (41.3)	12 Ga.	--	12 Ga.	--	<u>1 3</u>	<u>1</u>	<u>1 3</u>	--	<u>1</u>
B52	1 3/16" (20.6)	1 5/8" (41.3)	12 Ga.	--	--	--	<u>1</u>	<u>1</u>	<u>1</u>	--	<u>1</u>
B54	1 3/16" (20.6)	1 5/8" (41.3)	14 Ga.	.080	14 Ga.	14 Ga.	<u>1 2 3 4</u>	<u>1</u>	<u>1 2 3 4</u>	--	<u>1 2</u>
B56	1 3/16" (20.6)	1 5/8" (41.3)	16 Ga.	--	--	--	<u>1</u>	<u>1</u>	<u>1</u>	--	<u>1</u>

Channel Nuts

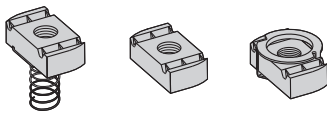

Size and Part Number

Thread Size	With Spring	Without Spring	Twirl Nut
1/4"-20	N224	N224WO	TN224
3/8"-16	N228	N228WO	TN228
1/2"-13	N225	N225WO	TN225
5/8"-11	N255	N255WO	--
3/4"-10	N275	N275WO	--

Available Finishes: Electro-Galvanized

Combo Nut Washers

Part Number	Thread Size
NW524	1/4"-20
NW528	3/8"-16
NW525	1/2"-13



Available Finishes: Electro-Galvanized

B2000 Series

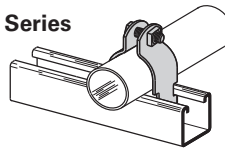

Copper Tubing Clamps DURA-COPPER™

Part No.	Nominal Tubing Size	Mat'l Ga.
B2026DCU	1/2" (15)	16
B2008DCU	3/4" (20)	16
B2030DCU	1" (25)	14
B2032DCU	1 1/4" (32)	14
B2011DCU	1 1/2" (40)	14
B2038DCU	2" (50)	12
B2042DCU	2 1/2" (60)	12
B2046DCU	3" (80)	12
B2050DCU	3 1/2" (90)	12
B2054DCU	4" (100)	11

Available Finishes: Electro-Galvanized, Aluminum, Stainless, DURA-COPPER Painted, Hot-Dip Galvanized and PVC coated. Nut and bolts are included with all two-piece clamps.

** Add "PA" to Part No. for Pre-assembled

Schedule 40 Pipe Clamps

Part No.	Nominal Pipe Size	Mat'l Ga.
B2001	3/8" (10)	16
B2008	1/2" (15)	16
B2009	3/4" (20)	14
B2010	1" (25)	14
B2011	1 1/4" (32)	14
B2012	1 1/2" (40)	12
B2013	2" (50)	12
B2014	2 1/2" (60)	12
B2015	3" (80)	12
B2016	3 1/2" (90)	11
B2017	4" (100)	11
B2018	4 1/2" (115)	11
B2019	5" (125)	11
B2020	6" (150)	11
B2021	7" (175)	11
B2022	8" (200)	11

All dimensions in charts and on drawings are in inches. Dimensions shown in parentheses are in millimeters unless otherwise specified.

Below are some basic clamp and cushions to be used with a strut system. For the industry's most complete line of strut and strut fittings, refer to B-Line series Strut Systems catalog.

B2000 Series

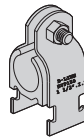
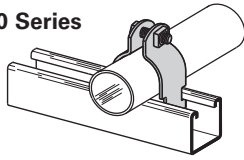

BVT & BVP Series Vibra-Clamp™

For Copper Tubing & OD Sizes

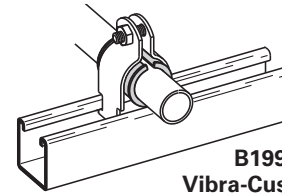

B1999 Vibra-Cushion™

O.D. Pipe Clamps

Part No.	O.D. Size (Outside Dia.)	Mat'l Ga.
B2023	1/4" (6.3)	16
B2024	3/8" (9.5)	16
B2025	1/2" (12.7)	16
B2026	5/8" (15.9)	16
B2027	3/4" (19.0)	16
B2028	7/8" (22.2)	16
B2029	1" (25.4)	14
B2030	1 1/8" (28.6)	14
B2031	1 1/4" (31.7)	14
B2032	1 3/8" (34.9)	14
B2004	1 1/2" (38.1)	14
B2011	1 5/8" (41.3)	14
B2005	1 3/4" (44.4)	12
B2036	1 7/8" (47.6)	12
B2037	2" (50.8)	12
B2038	2 1/8" (54.0)	12
B2039	2 1/4" (57.1)	12
B2013	2 3/8" (60.3)	12
B2041	2 1/2" (63.5)	12
B2042	2 5/8" (66.7)	12
B2043	2 3/4" (69.8)	12
B2014	2 7/8" (73.0)	12
B2045	3" (76.2)	12
B2046	3 1/8" (79.4)	12
B2047	3 1/4" (82.5)	12
B2048	3 3/8" (85.7)	12
B2015	3 1/2" (88.9)	12
B2050	3 5/8" (92.1)	11
B2051	3 3/4" (95.2)	11
B2016	4" (101.6)	11
B2054	4 1/8" (104.8)	11
B2055	4 1/4" (107.9)	11
B2056	4 3/8" (111.1)	11
B2017	4 1/2" (114.3)	11
B2058	4 5/8" (117.5)	11
B2059	4 3/4" (120.6)	11
B2060	4 7/8" (123.8)	11
B2061	5" (127.0)	11
B2062	5 1/8" (130.2)	11
B2063	5 1/4" (133.3)	11
B2064	5 3/8" (136.5)	11
B2065	5 1/2" (139.7)	11

Catalog No.	Copper & Steel OD Tubing Size	Nominal Copper Size
BVT025	1/4" (6.3)	—
BVT037	3/8" (9.5)	1/4" (6)
BVT050	1/2" (12.7)	3/8" (10)
BVT062	5/8" (15.9)	1/2" (15)
BVT075	3/4" (19.0)	5/8" (17)
BVT087	7/8" (22.2)	3/4" (20)
BVT100	1" (25.4)	—
BVT112	1 1/8" (28.6)	1" (25)
BVT125	1 1/4" (31.7)	—
BVT137	1 3/8" (34.9)	1 1/4" (32)
BVT150	1 1/2" (38.1)	—
BVT162	1 5/8" (41.3)	1 1/2" (40)
BVT175	1 3/4" (44.4)	—
BVT187	1 7/8" (47.6)	—
BVT200	2" (50.8)	—
BVT212	2 1/8" (54.0)	2" (50)
BVT225	2 1/4" (57.1)	—
BVT250	2 1/2" (63.5)	—
BVT262	2 5/8" (66.7)	2 1/2" (65)
BVT300	3" (76.2)	—
BVT312	3 1/8" (79.4)	3" (80)
BVT362	3 5/8" (92.1)	3 1/2" (90)
BVT400	4" (101.6)	—
BVT412	4 1/8" (104.8)	4" (100)
BVT612	6 1/8" (155.6)	6" (150)

Available for tubing and pipe sizes 1/4" to 6", OD sizes 1/4" to 6 5/8". Easy one tool installation, dampens vibration and noise, secures tubing firmly, and protects against galvanic reaction.

Stainless Steel available

For Pipe Sizes

Catalog No.	Nominal Pipe Size
BVP025	1/4" (6)
BVP037	3/8" (10)
BVP050	1/2" (15)
BVP075	3/4" (20)
BVP100	1" (25)
BVP125	1 1/4" (32)
BVP150	1 1/2" (40)
BVP200	2" (50)
BVP250	2 1/2" (65)
BVP300	3" (80)
BVP350	3 1/2" (90)
BVP400	4" (100)
BVP500	5" (125)
BVP600	6" (150)

- Inhibits Galvanic Reaction
- Reduces Sound & Vibration
- Used on refrigeration, HVAC, copper tubing, glass pipes & hydraulic lines Available in 20 Ft. rolls.

For Rigid Conduit or Iron Pipe

Nominal Size	Length of Vibra-Cushion	Use Clamp No.
3/8" (10)	2 1/8" (54.0)	B2002
1/2" (15)	2 5/8" (66.7)	B2009
3/4" (20)	3 1/4" (82.5)	B2031
1" (25)	4 1/8" (104.8)	B2004
1 1/4" (32)	5 3/16" (131.8)	B2012
1 1/2" (40)	5 5/16" (150.8)	B2038
2" (50)	7 1/2" (190.5)	B2042
2 1/2" (65)	9" (228.6)	B2046
3" (80)	11" (279.4)	B2051
3 1/2" (90)	12 1/2" (317.5)	B2055
4" (100)	14 1/2" (368.3)	B2059
5" (125)	17 7/16" (442.9)	B2067
6" (150)	20 3/4" (527.0)	B2116

For Thinwall (EMT) Conduit

Nominal Size	Length of Vibra-Cushion	Use Clamp No.
3/8" (10)	1 13/16" (46.0)	B2027
1/2" (15)	2 3/16" (58.7)	B2002
3/4" (20)	2 7/8" (73.0)	B2003
1" (25)	3 5/8" (92.1)	B2032
1 1/4" (32)	4 3/8" (120.6)	B2036
1 1/2" (40)	5 7/16" (138.1)	B2012
2" (50)	6 7/8" (174.6)	B2013

For Thinwall (EMT) Conduit

Nominal Size	Length of Vibra-Cushion	Use Clamp No.
1/4" (6)	1 3/16" (30.2)	B2026
3/8" (10)	1 9/16" (39.7)	B2027
1/2" (15)	1 7/8" (47.6)	B2028
5/8" (17)	2 5/16" (58.7)	B2029
3/4" (20)	2 3/4" (69.8)	B2030
1" (25)	3 1/2" (88.9)	B2032
1 1/4" (32)	4 5/16" (109.5)	B2011
1 1/2" (40)	5 1/8" (130.2)	B2036
2" (50)	6 1/16" (169.9)	B2013
2 1/2" (65)	8 1/4" (209.5)	B2014
3" (80)	9 13/16" (249.2)	B2048
3 1/2" (90)	11 3/8" (288.9)	B2052
4" (100)	12 15/16" (328.6)	B2056
5" (125)	16 1/8" (409.6)	B2064
6" (150)	19 1/4" (488.9)	B2112
8" (200)	25 1/2" (647.7)	B2128

All dimensions in charts and on drawings are in inches. Dimensions shown in parentheses are in millimeters unless otherwise specified.

MATERIALS

Carbon Steel

Carbon steel is used in the manufacture of B-Line series pipe hangers and supports. Excellent strength characteristics and adaptability to cold forming provide a well engineered design. By cold forming the steel, mechanical properties are increased, adding to the structural integrity of the fabricated hanger.

Stainless Steel

AISI Type 304 and Type 316 are non-magnetic members of the austenitic stainless steel group. Several conditions make the use of stainless steel ideal. These include reducing long term maintenance costs, high ambient temperatures, appearance, and stable structural properties such as yield strength, and high creep resistance.

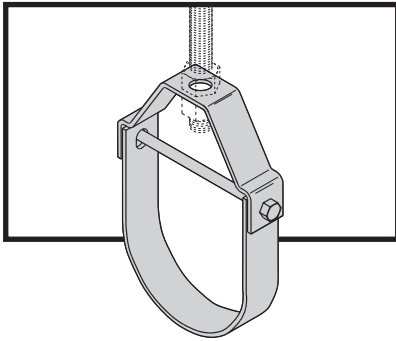

CORROSION

All metal surfaces exposed to the environment are affected by corrosion. Depending on the physical properties of the metal and its proximity to other dissimilar metals, an electrochemical reaction may occur which causes an attack on the metal itself, resulting in corrosion. Chemical corrosion is limited to highly corrosive environments, high temperatures, or a combination of both.

FINISHES

Zinc Coatings

Protective zinc coatings are available on a number of pipe hangers and accessories in three basic forms: Electro-galvanized, pre-galvanized, and hot-dip galvanized after fabrication. In all cases, the zinc protects the steel first as a sacrificial anode to repair bare areas on cut edges and gouges.

When exposed to air and moisture, zinc forms a tough, adherent protective film consisting of a mixture of zinc oxides, hydroxides, and carbonates. The corrosion resistance of zinc is directly related to its thickness and the environment. For example a 0.2 mil (5 μm) coating will last twice as long as a 0.1 mil (2.5 μm) coating in the same environment.

Electro-Galvanized (ASTM B633 SC1 or SC3)

An electro-galvanized process deposits a coating of zinc on the steel by electrolysis from a bath of zinc salts. This coating is pure zinc and adheres to the steel with a molecular bond. A maximum of 0.5 mils (12.7 μm) of zinc can be applied by this method. This coating is recommended for in-door use in relatively dry areas.

Pre-Galvanized Zinc (ASTM A653 Coating Designation G90)

Pre-galvanized zinc is produced by continuously rolling the steel coils or sheets through molten zinc at the steel mills. This is also known as "mill-galvanized" or "hot-dipped mill galvanized". Coils are then slit to size for fabrication of pipe hangers. Coating thicknesses of G90, is 0.90 ounces per square foot (0.27 kg/m^2) of steel surface.

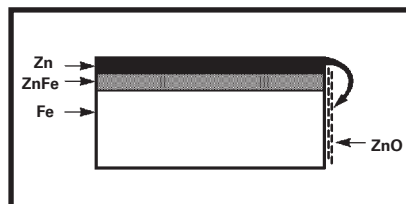

Protection of cut edges with zinc coatings.

Cut edges and welded areas are not zinc coated; however, zinc near the uncoated metal becomes a sacrificial anode which protects the bare areas after a short period of time. Pre-galvanized steel is not generally recommended for use outdoors in industrial environments, but is suitable for extended exposure in dry or mildly corrosive atmospheres.

Hot-Dip Galvanized After Fabrication (ASTM A123)

After a pipe hanger or fitting has been fabricated, it is completely immersed in a bath of molten zinc. A metallurgical bond is formed, resulting in a zinc coating that completely coats all surfaces, including edges. Zinc coatings of this specification have a minimum thickness of 1.50 ounces per square foot (0.45 kg/m^2) on each side or a total of 3.0 ounces per square foot (0.9 kg/m^2) of steel.

Hot-dip galvanized after fabrication is recommended for outdoor exposure. For best results, a zinc rich paint (available from Eaton) should be applied to field cuts. The zinc rich paint will provide immediate protection for field cuts and eliminate the short time period for galvanic action to "heal" the damaged coating.

Plastic Coating

Some products offered by Eaton are plastic or vinyl coated for prevention of galvanic reaction between materials or for noise reduction. These coated products can also be used where contact between glass pipe and hanger is not desirable. Felt lined hangers may be substituted for same purpose.

Red Primer

A corrosion resistant metal primer containing rust inhibitive pigments.

DURA-COPPER and DURA GREEN Epoxy Coatings

DURA-COPPER™ and DURA GREEN™ are water borne epoxy coatings applied to B-Line series products by a precisely controlled cathodic electro-deposition process. This process is accomplished using a conveyor to transport parts through several cleaning, phosphatizing and application stages prior to being baked (See diagram below).

This custom designed paint system is used for painting all copper painted hanger parts and all green channel, slotted angle and fittings.

Samples are selected on a routine basis for Salt Spray (fog) testing to verify the quality of the finish. These tests are performed in accordance with ASTM B117-73 and evaluated and rated according to ASTM D1654-79 (Tables 1 & 2). The DURA-COPPER and DURA GREEN Epoxy coatings have been tested and listed by Underwriters Laboratories in accordance with "Standard for Pipe Hanger Equipment for Fire Protection Service, UL 203" and meet or exceed all requirements of Federal Specification TT-C-490B Paragraph 3.

Quality Assurance

Eaton's Quality Assurance Program has been developed and implemented for compliance to various industry standards and specifications.

DURA-COPPER & DURA GREEN EPOXY COATING PROCESS

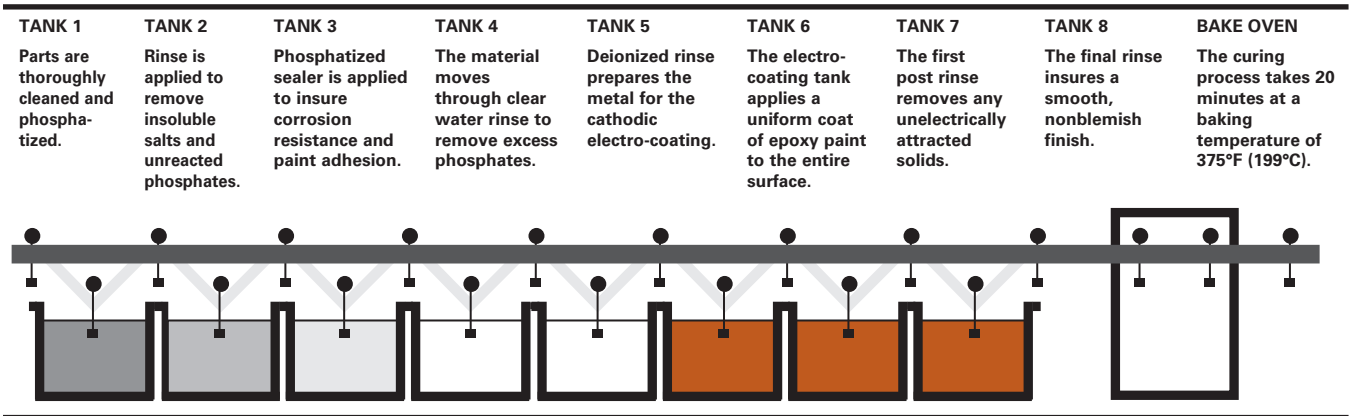

SALT SPRAY TEST RESULTS

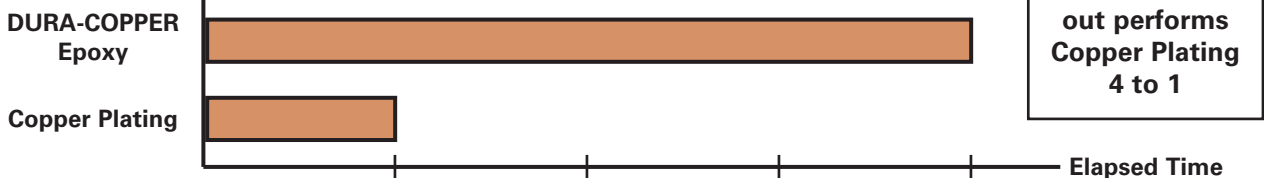

(1) All salt spray (fog) tests conducted in accordance with ASTM B117-73 and evaluated and rated according to ASTM D1654-79 Tables 1 & 2. Tests were performed and certified by an independent testing laboratory.

General Information

Torque

The torque values in this catalog are to be used as a guide only. The relationship between the applied torque or torque wrench reading and the actual tension created in the bolt may be substantially different. Important factors affecting torque-tension relationships include friction under the bolt head or nut, hole tolerances, and torque wrench tolerances. Accuracy of many commercial torque wrenches may vary as much as plus or minus 25%.

Charts and Tables

Charts and tables in this section are compiled from information published by nationally recognized organizations and are intended for use as a guide only. Eaton recommends that users of this information determine the validity of such information as applied to their own applications.

Eaton reserves the right to make specification changes without notice.

Pipe Clamps

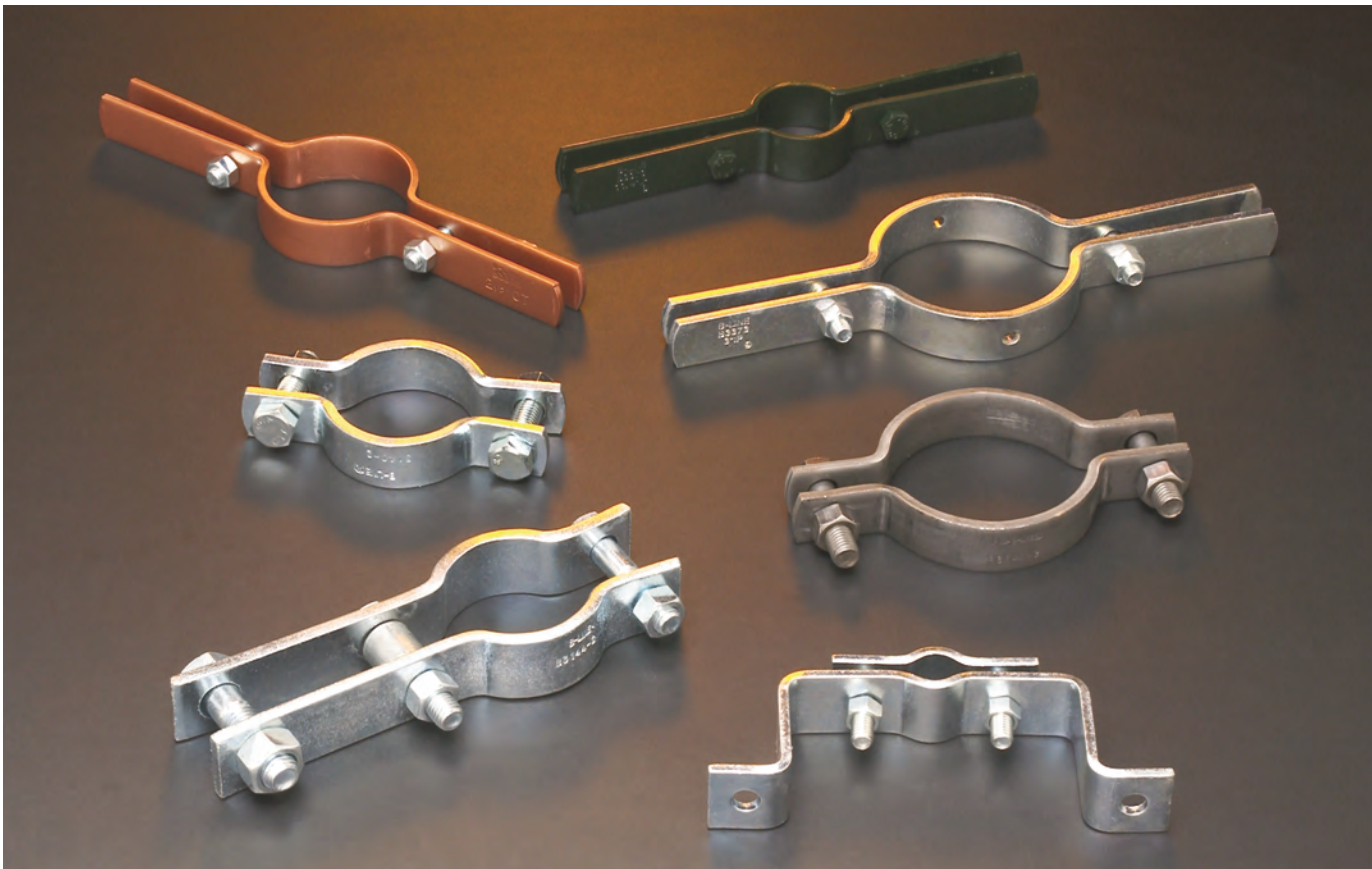

Pipe clamps offered in this section are designed for support and attachment of pipe to structural members. A wide range of pipe clamps are available for various applications.

Materials

Carbon Steel is used in the manufacturing of riser and pipe clamps. Stainless Steel and other materials are available.

Finishes

The standard finishes for mechanical supports are plain steel (oil coated) sometimes referred to as black and Electro-Galvanized Zinc (ASTM B633 SC3). Hot-Dip Galvanized After Fabrication (ASTM A123), Red Primer, Plastic Coating, DURA GREEN™, DURA-COPPER™ and other special coatings are available upon request.

Note: Due to the design of some products, (threads, connecting hardware, swivels, etc.) items may or may not be uniformly coated with special finishes. In some cases, the hanger itself may be coated, however, the hardware may be supplied Electro-Plated, Copper Plated, or in Stainless Steel.

Recommended Torque (Pipe Clamp Hardware)

1/4"-20	5/16"-18	3/8"-16	1/2"-13	5/8"-11	3/4"-10 & larger
6 ft/lbs (8 Nm)	11 ft/lbs (19 Nm)	19 ft/lbs (26 Nm)	50 ft/lbs (68 Nm)	65 ft/lbs (88 Nm)	75 ft/lbs (101 Nm)

Approvals (as noted)

Items in this section are Underwriters Laboratories Listed, Factory Mutual Approved, and comply with Federal Specification WW-H-171E & A-A-1192A or Manufacturers Standardization Society ANSI/MSS SP-69 & SP-58.

All pipe hangers and supports in this section are sized to fit schedule 40/80 pipe unless otherwise noted. Some steel items may be specially fabricated to fit other pipe diameters i.e. ductile iron, cast iron, etc. Select pipe O.D. from charts on pages 307 thru 312.

All dimensions in charts and on drawings are in inches. Dimensions shown in parentheses are in millimeters unless otherwise specified.

Pipe Clamps

BVT Series - Vibra-Clamp™

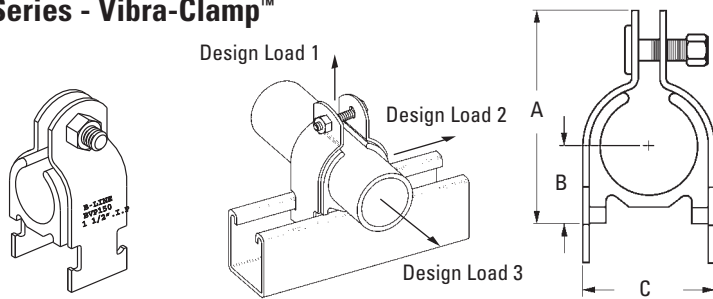

- Easy one tool installation.
- Temperature Range:
-40°F (-40°C) to +300°F (148.9°C)
- Dampens vibration and noise.
- Eliminates galvanic corrosion due to metal to metal contact.
- Resists most industrial oils and solvents.
- Secures tubing firmly to strut channel.

Part No.	O.D. Size		Pipe Size		Dimensions			Wt. Each Lbs. (kg)				
	in.	(mm)	in.	(mm)	A in.	B in.	C in.					
BVT025	1/4"	(6.3)	1/8"	(3)	1.22"	(30.9)	0.19"	(4.8)	0.49"	(12.4)	.11	(.05)
BVT037	3/8"	(9.5)	1/4"	(6)	1.36"	(34.5)	0.25"	(6.3)	0.61"	(15.5)	.12	(.05)
BVT050	1/2"	(12.7)	3/8"	(10)	1.49"	(37.8)	0.31"	(7.8)	0.74"	(18.8)	.14	(.06)
BVT062	5/8"	(15.9)	1/2"	(15)	1.62"	(41.1)	0.38"	(9.6)	0.86"	(21.8)	.15	(.07)
BVT075	3/4"	(19.0)	5/8"	(17)	1.87"	(47.4)	0.50"	(12.7)	1.15"	(29.2)	.19	(.08)
BVT087	7/8"	(22.2)	3/4"	(20)	2.00"	(50.8)	0.56"	(14.2)	1.27"	(32.2)	.21	(.09)
BVT112	1 1/8"	(28.6)	1"	(25)	2.25"	(57.1)	0.69"	(17.5)	1.52"	(38.6)	.26	(.12)
BVT137	1 3/8"	(34.9)	1 1/4"	(32)	2.51"	(63.7)	0.81"	(20.6)	1.78"	(45.2)	.38	(.17)
BVT162	1 5/8"	(41.3)	1 1/2"	(40)	3.00"	(76.2)	1.00"	(25.4)	2.20"	(55.9)	.40	(.18)
BVT212	2 1/8"	(54.0)	2"	(50)	3.52"	(89.4)	1.25"	(31.7)	2.70"	(68.6)	.55	(.25)
BVT262	2 5/8"	(66.6)	2 1/2"	(65)	4.02"	(102.1)	1.50"	(38.1)	3.20"	(81.3)	.55	(.25)
BVT312	3 1/8"	(79.4)	3"	(80)	4.53"	(115.0)	1.75"	(44.4)	3.70"	(93.9)	.64	(.29)
BVT362	3 5/8"	(92.1)	3 1/2"	(90)	5.05"	(128.2)	2.00"	(50.8)	4.23"	(107.4)	.76	(.34)
BVT412	4 1/8"	(104.8)	4"	(100)	5.55"	(140.9)	2.25"	(57.1)	4.73"	(120.1)	.93	(.42)
BVT612	6 1/8"	(155.5)	6"	(150)	7.62"	(193.5)	3.25"	(82.5)	6.74"	(171.1)	1.36	(.61)

Part No.	Design Load 1		Design Load 2		Design Load 3	
	Lbs.	(kN)	Lbs.	(kN)	Lbs.	(kN)
BVT025	400	(1.78)	50	(0.22)	50	(0.22)
BVT037	400	(1.78)	50	(0.22)	50	(0.22)
BVT050	400	(1.78)	50	(0.22)	50	(0.22)
BVT062	400	(1.78)	50	(0.22)	50	(0.22)
BVT075	600	(2.67)	75	(0.33)	75	(0.33)
BVT087	600	(2.67)	75	(0.33)	75	(0.33)
BVT112	600	(2.67)	75	(0.33)	75	(0.33)
BVT137	600	(2.67)	75	(0.33)	75	(0.33)
BVT162	800	(3.56)	125	(0.55)	125	(0.55)
BVT212	800	(3.56)	125	(0.55)	125	(0.55)
BVT262	800	(3.56)	125	(0.55)	125	(0.55)
BVT312	800	(3.56)	125	(0.55)	125	(0.55)
BVT362	1000	(4.45)	200	(0.67)	150	(0.67)
BVT412	1000	(4.45)	200	(0.67)	150	(0.67)
BVT612	1000	(4.45)	200	(0.67)	150	(0.67)



All dimensions in charts and on drawings are in inches. Dimensions shown in parentheses are in millimeters unless otherwise specified.