

3000® SERIES RACEWAY



Single-Channel Raceway. Easy-to-install and ideal for basic power or communication/low voltage installations. Well-suited for labs, hospitals, or anywhere that requires the capacity of a medium size raceway.

CODE REFERENCE

cULus Listed Raceway:
File E4376 Guide RJBT.

Fittings:
File E41751 Guide RJPR.
Meets Article 386 of NEC.
Meets Section 12-1600 of CEC.

System Layout

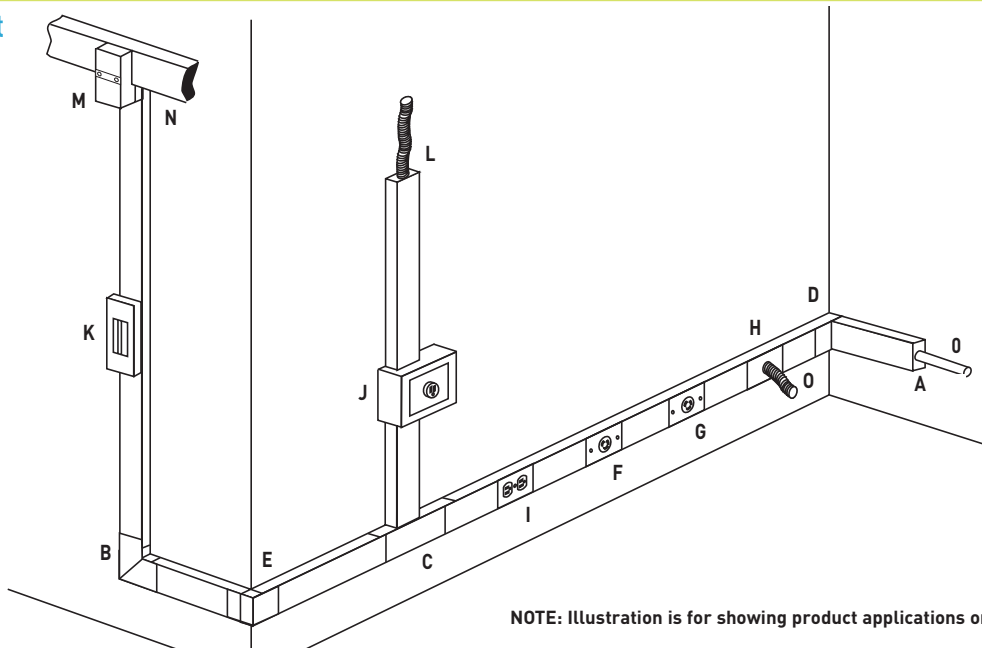

NOTE: Illustration is for showing product applications only.

KEY

- | | | | |
|-------------------------------------|-----------------------------------------------|----------------------------------------------|-----------------------------------------------------------|
| A. 3010B Blank End Fitting | F. 3027AE Single Receptacle Cover | J. 3044-2 Extra Deep Switch & Receptacle Box | M. 4074A Take Off Connector – 4000 to 3000 Series Raceway |
| B. 3011E 90° Flat Elbow | G. 3033JE Single Receptacle Cover | K. 3046KD Circuit Breaker Housing | N. 4000 Series Raceway |
| C. 3015E Tee Fitting | H. 3036HE Blank Cover | L. 3082 Conduit Connector | O. CONDUIT 1/2" [12.7mm] Flexible Metal Conduit |
| D. 3017TCE Internal Corner Coupling | I. 3043GE Duplex Grounding Receptacle & Cover | | |
| E. 3018AE External Corner Coupling | | | |

COLOR OPTIONS



3000® Series Raceway Part Numbers with a "V" prefix have an ivory finish. Part Numbers with a "G" prefix have a gray finish.

Custom color options are also available. Consult the factory for more information.

3000 SERIES® RACEWAY

3000 Series Raceway Ordering Information (continued)

V3011E, G3011E Flat Elbow Fitting

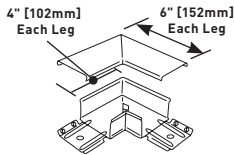

Right angle turns on the same surface.

IWE-P, GWE-P Touch-Up Paint Pen



Used for touching up small areas. Contains 0.3 oz. of paint. Available in ivory (IWE-P) and gray (GWE-P).

V3014C, G3014C Wall Box Connector

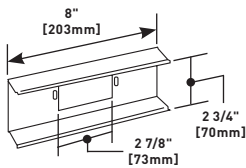

Connects 3000 Series Raceway from flushed-in wall box.

V3018AE, G3018AE External Corner Coupling

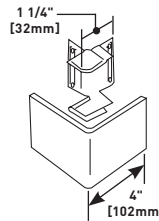

Right angle turns around external corners.

Use with G3017TCE to offset around columns etc. (minimum 4" [102mm] offset).

V3015E, G3015E Tee Fitting

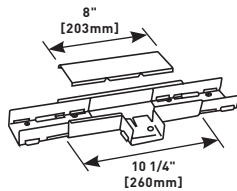

For branching raceway at right angles. Three couplings included.

V3027AE, G3027AE Single Receptacle Cover

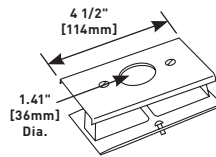

Installs commercially available straight blade and locking single receptacles with face diameters of 1.38"-1.40" [35mm-36mm] into 3000 Series Raceway. G3007C Device Bracket included.

V3017TCE, G3017TCE Internal Corner Coupling

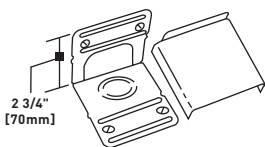

For surfaces at right angles, or for use as a straight-through fitting. Solid leg of base has concentric 1/2" and 3/4" trade size KOs.

G3017TCE used as a straight-through fitting.

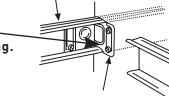

V3028, G3028 Utility Box

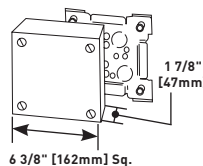

Used as a tee, cross, junction box, or for branch circuit extensions in 3000 Series Raceway. Cover has raceway twistouts on all sides. Base has five 1/2" trade size KOs and four fixture mounting holes.

V3033JE, G3033JE Single Receptacle Cover

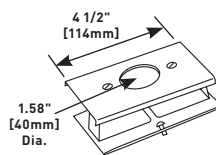

Installs commercially available straight blade and locking single receptacles with face diameters of 1.56"-1.57" (approximately [40mm]) into 3000 Series Raceway. G3007C Device Bracket included.

	#6 AWG	#8 AWG	#10 AWG	#12 AWG	#14 AWG
THHN, THWN	13	18	24	55	75

IWE-S, GWE-S Spray Paint



Used for touching up large areas. Contains 12 oz. of paint. Available in ivory (IWE-S) and gray (GWE-S).

NOTE: Can only be shipped via ground transportation

V3036HE, G3036HE Blank Cover

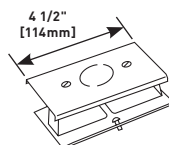

Use as a blank cover or tap off KO in center of plate for 1/2" trade size conduit. G3007C Device Bracket included.

NOTE: Parts identified with this symbol are Certified to Canadian Safety Standards for sale in Canada. When ordering these products, change the "V" color prefix to "CV" or the "G" color prefix to "CG" to denote the Canadian versions.