

## 163

Replaces Bussmann series 164

### Specifications

**Description:** Power terminal block.

**Dimensions:** See Dimensions illustrations.

**Construction:** Tin-plated aluminum connectors.

**Poles:** 1- to 3-poles, See catalog numbers table on the following page.

**Wire range:** See catalog numbers table on the following page.

### Ratings:

Volts: — 600Vac/dc

Amps: — See catalog numbers table on the following page.

SCCR: — 10kA per UL 508A table SB4.1 (except for select products noted in table)

**Agency information:** CE, UL Recognized: Guide XCFR2, UL E62622, General Industrial Class per UL1059, CSA Certified: CSA 053787

**Flammability rating:** UL 94V0



Supplied with (4) #4 thread-cutting screws assembled as shown

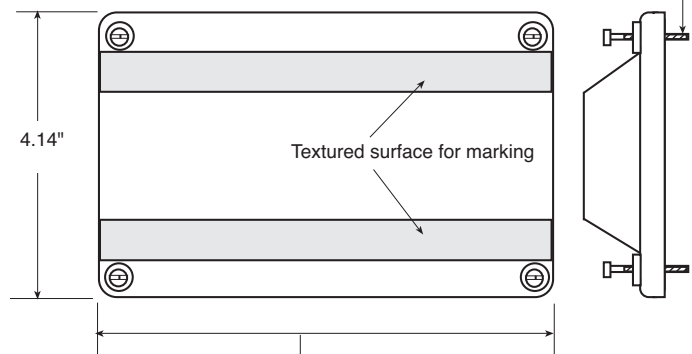

CPDB-1	(single pole)	2.10"
CPDB-2	(two pole)	3.72"
CPDB-3	(three pole)	5.34"

### Dimensions

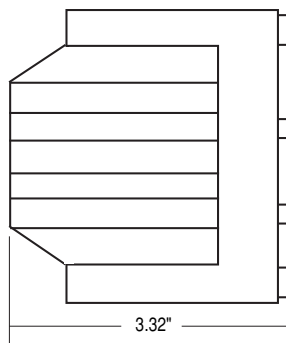
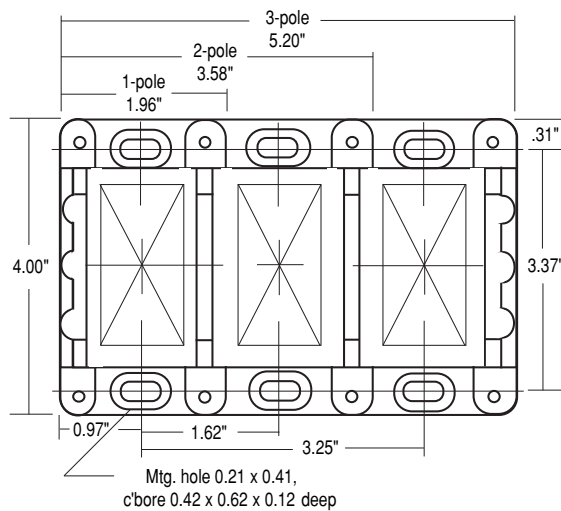



















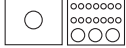

(See following page for ratings)

Data Sheet: 1049

**Catalog numbers**

## Basic

catalog numbers	Wire size (poles) lineside	(poles) loadside	Amps/pole	Line/load
16301*	250kcmil-6 AWG Cu only	250kcmil-6 AWG Cu only	255	
16303	350kcmil-6 AWG Cu-Al	350kcmil-6 AWG Cu-Al	310	
16306	500kcmil-6 AWG Cu-Al	500kcmil-6 AWG Cu-Al	380	
16321**	2/0-14 AWG CU, 2/0-8Al	(6)4-14 AWG Cu, 4-8 AWG Al	175	
16323**	350kcmil-6 AWG Cu-Al	(6)4-14 AWG Cu, 4-12 AWG Al	310	
16325	(2)2/0-14 AWG Cu, 2/0-8 AWG Al	(6)4-14 AWG Cu, 4-8 AWG Al	350	
16330	500kcmil-6 AWG Cu-Al	(6) 2-14 AWG Cu, 2-12 AWG Al	380	
16332	350kcmil-6 AWG Cu-Al	(3) 2-14 AWG Cu, 2-8 AWG Al (2) 1/0-14 AWG Cu, 1/0-8 AWG Al	310	
16335	500kcmil-6 AWG Cu-Al	(3) 2-14 AWG Cu, 2-8 AWG Al (2) 1/0-14 AWG Cu, 1/0-8 AWG Al	380	
16370**	350kcmil-6 AWG Cu-Al	(12)4-14 AWG Cu, 4-12 AWG Al	310	
16371**	350kcmil-6 AWG Cu-Al	(6) 2-14 AWG Cu, 2-8 AWG Al (3) 1/0-14 AWG Cu, 1/0-8 AWG Al	310	
16372	350kcmil-6 AWG Cu-Al	(21) 10-14 AWG Cu, 10 AWG Al	310	
16373	350kcmil-6 AWG Cu-Al	(14) 10-14 AWG Cu, 10 AWG Al (3) 1/0-14 AWG Cu-Al	310	
16375	600kcmil-2 AWG Cu-Al	(12)4-14 AWG Cu, 4-12 AWG Al	420	
16376	600kcmil-2 AWG Cu-Al	(6) 2-14 AWG Cu, 2-8 AWG Al (3) 1/0-14 AWG Cu, 1/0-8 AWG Al	420	
16377	(2)300kcmil-4 AWG Cu-Al	(12)4-14 AWG Cu, 4-12 AWG Al	570	
16378	500kcmil-6 AWG Cu-Al	Stud size (2) 1/4-20 x 1	380	
16383	500kcmil-6 AWG Cu-Al	Stud size (1) 3/8-16 x 1	380	
16390	3/8-16 x 1 1/8 stud size	3/8-16 x 1 1/8 stud size	250	
16394	1/2-13 x 1 1/16 stud size	1/2-13 x 1 1/16 stud size	400	
16395	3/8-16 x 1 1/16 stud size	(2) 1/4-20 x 3/16 stud size	310	

\*Copper connectors for use with copper wire only.

\*\*SCCR up to 200kA

**Ordering information**

163 blocks are available in 1-, 2- or 3-poles. To order: basic catalog number + number of poles.

Examples: 16301-1 = one-pole block  
16301-3 = three-pole block