

Switching Devices

Safety Switches

Safety Switch Selection Guide

Type	Voltage	Fuse Type	Fuse Class	Ampere Rating	Number of Poles ^③	Enclosure Type			Type 4 Painted Steel	Type 4X Stainless Steel	Type 4X Non Metallic	NEMA 7/9 Hazardous Location
						Type 1	Type 3R	Type 12 ^①				
Air Conditioning Disconnect	Max. 240Vac	Fusible	Cartridge	H	30 and 60	2	—	Yes	—	—	—	—
		Non-Fusible	—	—	60	2	—	Yes	—	—	—	—
	Max. 240Vac	Moulded Case Switch	—	—	60	2	—	Yes	—	—	—	—
	Max. 600Vac	Non-Fusible	—	—	30-80	3	—	Yes	—	—	—	—
General Duty	Single Throw	Fusible	Plug	—	30	1 and 2	Yes	Yes	—	—	—	—
	Max. 240Vac	Non-Fusible	Cartridge	H	30-600	2 and 3	Yes	Yes	—	—	—	—
		Non-Fusible	—	—	30-600	2 and 3	Yes	Yes	—	—	—	—
Heavy Duty	Single Throw	Fusible	Cartridge	H	30-600	2, 3, and 4	Yes	Yes	Yes ^{①②}	Yes ^②	Yes ^②	—
	Max. 600Vac	Non-Fusible	—	L	800-1200	Up to 1200A	Yes	Up to 1200A	Up to 1200A	400-1200A	Up to 1200A	—
	250 Vdc & 600 Vdc	Non-Fusible	—	—	30-1200	2, 3, and 4	Yes	Yes	Yes ^{①②}	Yes ^②	Yes ^②	—
6-Pole Motor Circuit^②	Single Throw	Fusible	Cartridge	H	30-200	6	—	Yes	Yes ^{①②}	—	Yes ^②	—
	Max. 600Vac	Non-Fusible	—	—	30-200	6	—	Yes	Yes ^{①②}	—	Yes ^②	—
Double Throw^③	Max. 600VAV	Fusible	Cartridge	H	30-200	2 and 3	Yes	Yes	Yes ^{①②}	Yes ^②	Yes ^②	—
	250Vdc	Non-Fusible ^③	—	T (240V)	400-1200	3	Yes	Yes	Yes ^{①②}	Yes ^②	400-600A	—
		Non-Fusible ^③	—	T (600V)	400-1200	2, 3, 4, 6	Yes	Yes	Yes ^{①②}	Yes ^②	Yes ^②	—
		Non-Fusible ^③	—	—	30-1200	3	Yes	Yes	Up to 400A	400-600A	Up to 200A	—
Enclosed Rotary Switches	Max. 600Vac	Non-Fusible	—	—	30-80	3	—	—	Yes ^①	—	Yes	Yes
Hazardous Location Disconnect Switch	Max. 600Vac	Fusible	Cartridge	J	30-100	3	—	—	—	—	—	Yes
	250Vdc	Non-Fusible	—	—	30-100	3	—	—	—	—	—	Yes
EnviroLine All Stainless^②	Single Throw	Fusible	Cartridge	H	30-400	2 and 3	—	—	—	—	Yes ^②	—
	Max. 600Vac/DC	Non-Fusible	—	—	30-400	3	—	—	—	—	Yes ^②	—
Viewing Window	Single Throw	Fusible	Cartridge	H	30-1200	2, 3, 4, 6	—	—	Yes ^①	Yes	Yes	—
	Max. 600Vac/DC	Non-Fusible	—	—	30-1200	2, 3, 4, 6	—	—	Yes ^①	Yes	Yes	—
Receptacle (Pin & Sleeve)^②	Single Throw	Fusible	Cartridge	H	30-100	3	—	—	Yes ^{①②}	—	Yes ^②	—
	Max. 600Vac/DC	Non-Fusible	—	—	60	3	—	—	Yes ^{①②}	—	Yes ^②	—
Quick Connect (Cam & Posi Lok)	Single Throw	Fusible	Cartridge	H	100-600	2, 3, and 4	Yes	Yes	—	—	—	—
	Max. 600Vac	Non-Fusible	—	L	800	2, 3, and 4	Yes	Yes	—	—	—	—
	Double Throw	Non-Fusible	—	—	100-800	2, 3, and 4	Yes	Yes	—	—	—	—
	Max. 600Vac	w Non-Fusible w Fuse	—	—	—	2, 3, and 4	Yes	Yes	—	—	—	—
		Cartridge	H	100-200	2, 3, and 4	Yes	Yes	—	—	—	—	
		Cartridge	T	400-800	2, 3, and 4	Yes	Yes	—	—	—	—	
Solar	Single Throw	Fusible	—	R	30-600	1 (3)	—	Yes	Yes ^{①②}	Yes ^②	—	—
	Max. 600Vdc	Non-Fusible	—	—	30-600	1 (3)	—	Yes	Yes ^{①②}	Yes ^②	—	—

Notes

① Type 12 enclosures (30-1200 amperes) can be field modified to meet Type 3R rainproof requirements when a factory provided drain screw is removed.

② Optional windows also available with type 12 or 4/4X enclosures.

③ Double throw non-fusible 4 pole 30-800A, 6 pole 30-100A.

Product Overview

- Used to open or close a circuit
- Non-fusible safety switches provide a means to manually connect or disconnect the load from the source
- Fusible safety switches provide a means to manually open and close a circuit and provide overcurrent protection by means of installed fuses
- Fusible switches certified for use as service entrance equipment (unless noted)
- Also commonly referred to as a disconnect switch or disconnect

- Available from 30–1200A
- All Padlockable
- Horsepower rated
- 100% load break rated (unless noted)
- Non-Fusible switches are 100% continuous duty rated and fusible switches are 80% continuous duty rated per CSA C22.2 No.4

Standards and Certifications

- C22.2 No.4 File #69743
- C22.2 No.14 (Enclosed Rotary) File #162136
- Det Norske Veritas
- ISO 9001:2008
- CSA certified Class I, Div, 1 & 2, Groups B, C & D; Class II, Div 1 & 2, Groups E, G & F; Class III, Div 1 & 2, Zone 1, IIB + H2 for NEMA 7/9.
- Seismic qualified (UBC and CBC) for Heavy Duty 30-800A
- ISO 1400

**Fuse Clips/Class**

Adaptable to Accept the Following Fuse Class

Safety Switch Type	Standard Fuse Class Clips Supplied with Switch	Adaptable to Accept the Following Fuse Class		
		R	J	T
AC Disconnect	H	—	—	—
General Duty	H	30A-600A	400-600A	400-600A
Heavy Duty	H 30-600A L 800-1200A	30A-600A	240V-100-600A 600V-30-600A	200A-800A 1200A
Heavy Duty 6 Pole	H	30A-200A	60A-200A	200A
Double Throw	H 30-200A T 240V-600A-1200A T 600V-400A-800A L 600V-1200A	30A-400A	240V-200A Only 600V-200A-400A	240V-600A-1200A 600V-400A-1200A (Standard)
Enviroline All Stainless & Window	Same as Heavy Duty	Same as Heavy Duty		Same as Heavy Duty
Receptacle (Pin & Sleeve)	H	30A-100A	60A-100A	—
Solar	R	30A - 600A	—	—

Note: Refer to specific switch technical data page for field adaptation notes.

Catalogue Number Selection

Safety Switch

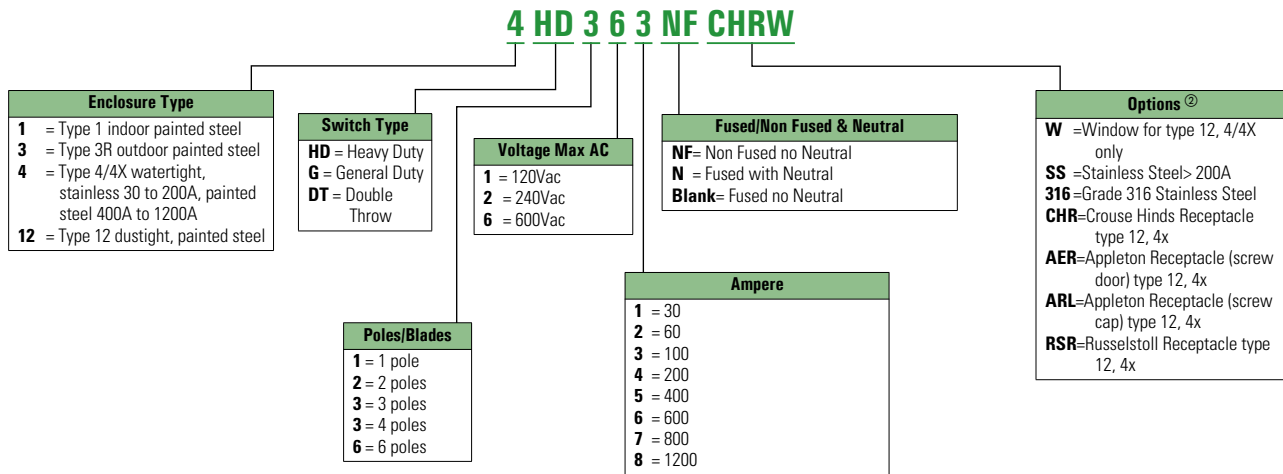

Notes

- ① Always verify the number of poles and wires required since catalogue numbers may appear in multiple tables.
 - ② See **Pages 12** through **14** for additional Flex Centre options.
- This table is intended for use in breaking down existing catalogue numbers. It is not intended for building new catalogue numbers.

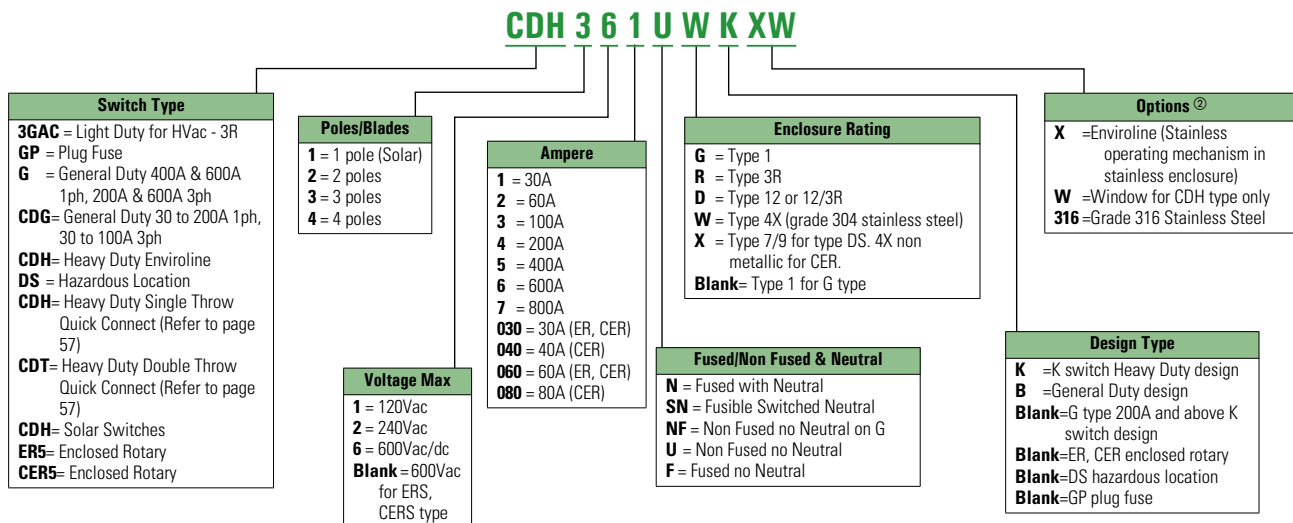

Heavy-Duty Safety Switch



Contents

<i>Description</i>	<i>Page</i>
Selection Guide	2
Product Overview	3
Catalogue Configurator	4
Options and Accessories	5
Technical Data and Specifications	7
Standard Terminal Capacities	7
Fuse Dimensions	8
Short Circuit Ratings	10
Flex/Satellite Modifications	12
Air Condition Disconnects	15
General Duty Switches	18
Heavy Duty Switches	22
Product Description, Features	22
Standards and Certifications	23
Product Selection	24
Technical Data and Dimensions	30
Heavy Duty Six-Pole Switches	32
Heavy Duty Double Throw Switches	35
Enviroline Switches	41
Heavy Duty Window Switches	44
Heavy Duty Receptacle Switches	48
Heavy Duty Voltage Indicator Switches	52
Hazardous Location Switches	54
Heavy Duty Quick Connect Switches	56
Solar Switches	60
Zone Blasting Switches	64
Elevator Control Switches	66
Grounding Switches	68
Enclosed Motor Disconnects	70
Pringle Bolted Pressure Switches	78
OEM Operating Mechanisms	85
CSA Enclosure Designations	91

Heavy-Duty

Application Description

For light to heavy commercial and industrial applications. Main service entrance, branch and motor circuit protection, disconnecting or transferring to alternate power source. Where reliable performance and service continuity are critical.

Product Description

- 30–1200A
- 600 Vac, 600 Vdc maximum
- Horsepower rated
- Fusible and non-fusible switches are 100% load break and 100% load make rated
- The continuous load current of fusible switches is not to exceed 80% of the rating of fuses employed in other than motor circuits. Non-fusible switches are 100%

- continuous load rated
- Fusible switches suitable for service entrance applications unless otherwise noted
- Enclosures, Type 1, 3R, 12/3R, 4 are painted steel ANSI 61 light grey electrocoat. and 4X are grade 304 stainless steel, grade 316 available upon request.
- For factory modifications, refer to **Pages 12 through 14**

240 Vac Heavy-Duty, Fusible, Single-Throw

- 30–1200A
- Horsepower rated
- Fusible switches suitable for service entrance use, except four-pole switches
- For accessories refer to **Pages 5 and 6**

600 Vac Heavy-Duty, Fusible, Single-Throw

- 30–1200A
 - Horsepower rated
 - Suitable for service entrance use, except four pole switches.
- Note:** Must use suitable ground fault protection @ 1200 Ampere for service entrance.

600 Vac Heavy-Duty, Non-Fusible, Single-Throw

- 30–1200A
- Horsepower rated
- Not suitable for service entrance per CEC

Features, Benefits and Functions

- Visible double-break quick-make, quick-break rotary blade mechanism. Two points of contact provide a positive open and close, easier operation, and also help prevent contact burning for longer contact life
- Triple padlocking capability. Personnel safety feature since the large hasp can accommodate up to three 3/8-inch (9.5 mm) shank locks. Cabinet door can be further padlocked at the top and bottom
- Interlocking mechanism. Door cannot be opened when the handle is in the ON position. Built-in defeater mechanism provides for user access when necessary
- Deionizing arc chutes; arc chutes confine and suppress the arcs produced by opening contacts under load
- Mechanically interlocked cover to prevent easy access when the switch is in the ON position
- Clear line shield with probe holes
- Clearly visible palm fitting red handle
- Tangential knockouts on Type 1 and Type 3R enclosures through 200A
- Built-in fuse pullers on Type 4X and Type 12 enclosures through 200A
- Additional door locking capability
- Complete accessory and renewal parts data shown on inner door label
- 30–1200A Type 12 designs convertible to Type 3R by opening factory-installed drain hole
- 30–1200A switches are seismic qualified and exceed the requirements of the Uniform Building CodeT (UBC) and California Code Title 24

- Two points of contact provide a positive open and close, easier operation, and also help prevent contact burning for longer contact life

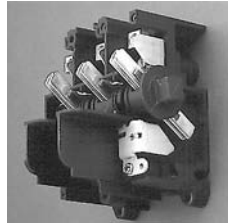

Visible Double-Break Rotary Blade Mechanism

- Protects against accidental contact with energized parts. Probe holes enable the user to test if the line side is energized without removing the shield.

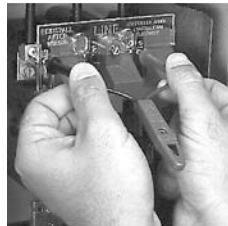

Clear Line Shield

- Provide easy removal of fuses

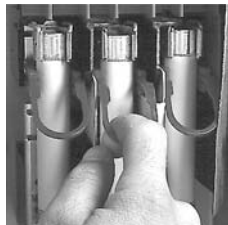

Built-In Fuse Pullers (Type 12 and 4X 30–200A)

- The position (ON or OFF) can be clearly seen from a distance and the length provides for easy operation



Clearly Visible Handle

- Personnel safety feature since the large hasp can accommodate up to three 3/8-inch (9.5 mm) shank locks



Triple Padlocking Capability

- Cabinet door can be further padlocked at the top and bottom as applicable



Additional Locking Capability

- Door cannot be opened when the handle is in the ON position. Front and side operable defeater mechanism provides for user access when necessary on single-throw switches



Interlocking Mechanism

- An ample number are provided on the top, bottom and sides of both NEMA Types 1 and 3R enclosures through 200A



Tangential Knockouts

- For switches in a Type 3R, 30–200A. Use a Myers type hub for all others

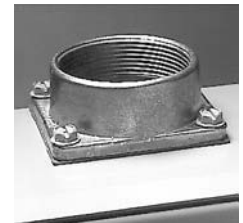

Bolt-On Hub Kits

- Type 12 and 4X 30–100A have padlockable suitcase latches vs screw type latches.





Padlockable Suitcase Latches

Standards and Certifications

- CSA Certified File No. 69743
- Meets C22.2 No. 4 for enclosed switches
- Refer to page 2 for additional certifications
- ISO 9001:2008

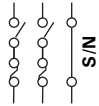
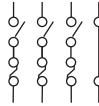

240 Vac Heavy-Duty, Fusible, Single-Throw, Fusible—Type 12/3R^①, 4X^③, and 4^④

System	Ampere Rating	Fuse Type Provision	Maximum Horsepower Ratings		Time Delay Single-Phase	Time Delay Three-Phase	DC 250V	Type 12/3R ^① Enclosure Dust-Tight Catalogue Number	Type 4X and 4 ^④ Enclosure Watertight Catalogue Number
			Standard Fuse Single-Phase	Standard Fuse Three-Phase					
Three-Wire (Two Blades, Two Fuses, S/N)—240 Vac, 250 Vdc									
	30	H	1-1/2	3	3	7-1/2	5	12HD221N ^①	4HD221N ^③
	60	H	3	7-1/2	10	15	10	12HD222N ^①	4HD222N ^③
	100	H	7-1/2	15	15	30	20	12HD223N ^①	4HD223N ^③
	200	H	15	25	15	60	40	12HD224N ^①	4HD224N ^③
	400	H	—	50	—	125	50	12HD225N ^①	4HD225NSS ^③
	400	H	—	50	—	125	50	—	4HD225N ^④
	600	H	—	75	—	200	—	12HD226N ^①	4HD226NSS ^③
	600	H	—	75	—	200	—	—	4HD226N ^④
	800	L	—	100	—	250	—	12HD227N ^①	4HD227NSS ^③
800	L	—	100	—	250	—	—	4HD227N ^④	
Four-Wire (Three Blades, Three Fuses, S/N)—240 Vac, 250 Vdc									
	30	H	1-1/2	3	3	7-1/2	5	12HD321N ^①	4HD321N ^③
	60	H	3	7-1/2	10	15	10	12HD322N ^①	4HD322N ^③
	100	H	7-1/2	15	15	30	20	12HD323N ^①	4HD323N ^③
	200	H	15	25	15	60	40	12HD324N ^①	4HD324N ^③
	400	H	—	50	—	125	50	12HD325N ^①	4HD325NSS ^③
	400	H	—	50	—	125	50	—	4HD325N ^④
	600	H	—	75	—	200	—	12HD326N ^①	4HD326NSS ^③
	600	H	—	75	—	200	—	—	4HD326N ^④
	800	L	—	100	—	250	—	12HD327N ^①	4HD327NSS ^③
	800	L	—	100	—	250	—	—	4HD327N ^④
	1200	L	—	—	—	—	—	12HD328N ^①	4HD328NSS ^③
	1200	L	—	—	—	—	—	—	4HD328N ^④
Four-Pole—240 Vac, 250 Vdc									
	30	H	3	3	10	7-1/2	5	12HD421F ^①	②
	60	H	7-1/2	7-1/2	20	15	10	12HD422F ^①	②
	100	H	15	15	30	30	20	12HD423F ^①	②
	200	H	30	25	50	60	40	12HD424F ^①	②
	400	H	50	50	—	125	50	②	②
	400	H	50	50	—	125	50	②	②
	600	H	—	75	—	200	—	②	②
600	H	—	75	—	200	—	②	②	

Notes

- ① Type 12 enclosures (30–1200A) can be field modified to meet NEMA 3R rainproof requirements when a factory provided drain hole is opened.
- ② Contact Customer Support (1-800-268-3578) for availability of this product.
- ③ Type 4x stainless steel enclosure.
- ④ Type 4 painted steel enclosure.

Note: For 'J' Fusing on 240V Heavy Duty Switches Field Modification Required.
 30-60 amperes not available.
 100-400 amperes, reposition loadside fuse block to accept 'J' fuse.
 600 amperes adapter kit included with switch.
 For 'R' fuse rejector adapter kit and 'T' fusing see page 5 accessory application options.

Dimensions

Approximate Dimensions in Inches (mm)

Note: Dimensions are for estimating purposes only.

Heavy-Duty, Non-Fusible, 600V, Three-Pole, Single-Throw

Ampere Rating	Width (W)	Height (H)	Depth (D)	Depth (D2)	Weight Lbs (kg)
Type 1, 3R					
30	8.13 (206.5)	15.88 (403.4)	9.89 (251.3)	5.25 (133.3)	16 (7.264)
60	8.13 (206.5)	15.88 (403.4)	9.89 (251.3)	5.25 (133.3)	16 (7.264)
100	11.13 (282.7)	21.69 (550.9)	9.89 (251.3)	5.25 (133.3)	22 (9.988)
200	15.91 (404)	27.63 (701.8)	11.25 (285.8)	6.14 (156.0)	46 (20.884)
400	22.66 (576)	44.31 (1125)	12.39 (315)	7.27 (184.7)	110 (49.94)
600	23.66 (601)	51.82 (1316)	14.07 (357)	8.95 (227.3)	135 (61.29)
800	25.38 (644.7)	56.24 (1428)	14.07 (357)	8.95 (227.3)	158 (71.732)
1200	40.00 (1016)	70.31 (1785.9)	19.94 (506.5)	12.44 (316.0)	430 (195.22)
Type 12, 4 Painted Steel, 4X Stainless Steel ①					
30	8.76 (222.5)	14.14 (359)	10.22 (259)	5.50 (139.7)	17 (7.718)
60	8.76 (222.5)	14.14 (359)	10.22 (259)	5.50 (139.7)	17 (7.718)
100	11.79 (299.5)	25.00 (634)	10.22 (259)	5.50 (139.7)	28 (12.712)
200	16.54 (421)	35.38 (899)	11.63 (295)	6.44 (163.6)	55 (24.97)
400	24.12 (613)	57.47 (1460)	12.43 (316)	7.19 (182.6)	125 (56.75)
600	25.08 (637)	63.00 (1600.2)	14.25 (362.0)	8.88 (225.6)	167 (75.818)
800	26.34 (669)	71.75 (1822.5)	14.25 (362.0)	8.88 (225.6)	175 (79.45)
1200	41.47 (1053.3)	73.77 (1874)	19.99 (506.5)	13.51 (343.2)	475 (215.65)

Type 1-3R Heavy-Duty 30–1200A

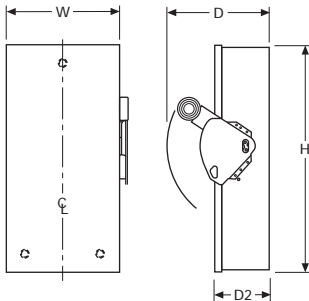

Heavy-Duty, Fusible, 240V and 600V, Three-Pole with or without Neutral, Single-Throw

Ampere Rating	Width (W)	Height (H)	Depth (D)	Depth (D2)	Weight Lbs (kg)
Type 1, 3R					
30	8.13 (206.5)	15.88 (403.4)	9.89 (251.3)	5.25 (133.3)	20 (9.08)
60	8.13 (206.5)	15.88 (403.4)	9.89 (251.3)	5.25 (133.3)	20 (9.08)
100	11.13 (282.7)	21.69 (550.9)	9.89 (251.3)	5.25 (133.3)	27 (12.258)
200	15.91 (404)	27.63 (701.8)	11.25 (285.8)	6.14 (156.0)	52 (23.608)
400	22.66 (576)	44.31 (1125)	12.39 (315)	7.27 (184.7)	120 (54.48)
600	23.66 (601)	51.82 (1316)	14.07 (357)	8.95 (227.3)	135 (61.29)
800	25.38 (644.7)	56.24 (1428)	14.07 (357)	8.95 (227.3)	168 (76.272)
1200	40.00 (1016)	70.31 (1785.9)	19.94 (506.5)	12.44 (316.0)	465 (211.11)
Type 12, 4 Painted Steel, 4X Stainless Steel ①					
30	8.76 (222.5)	19.08 (485)	10.22 (259)	5.50 (139.7)	22 (9.988)
60	8.76 (222.5)	19.08 (485)	10.22 (259)	5.50 (139.7)	22 (9.988)
100	11.79 (299.5)	25.00 (634)	10.22 (259)	5.50 (139.7)	30 (13.62)
200	16.54 (421)	35.38 (899)	11.63 (295)	6.44 (163.6)	61 (27.694)
400	24.12 (613)	57.47 (1460)	12.43 (316)	7.19 (182.6)	135 (61.29)
600	25.08 (637)	63.00 (1600.2)	14.25 (362.0)	8.88 (225.6)	203 (92.162)
800	26.34 (669)	71.75 (1822.5)	14.25 (362.0)	8.88 (225.6)	213 (96.702)
1200	41.47 (1053.3)	73.77 (1874)	19.99 (506.5)	13.51 (343.2)	510 (231.54)

Note

① Type 12 enclosures (30-1200A) can be field modified to meet type 3R rainproof requirements when factory provided drain hole is opened.

Type 4, 4X and 12 Heavy-Duty 30–1200A ①

