

163

Replaces Bussmann series 164

Specifications

Description: Power terminal block.

Dimensions: See Dimensions illustrations.

Construction: Tin-plated aluminum connectors.

Poles: 1- to 3-poles, See catalog numbers table on the following page.

Wire range: See catalog numbers table on the following page.

Ratings:

Volts: — 600Vac/dc

Amps: — See catalog numbers table on the following page.

SCCR: — 10kA per UL 508A table SB4.1 (except for select products noted in table)

Agency information: CE, UL Recognized: Guide XCFR2, UL E62622, General Industrial Class per UL1059, CSA Certified: CSA 053787

Flammability rating: UL 94V0



Supplied with (4) #4 thread-cutting screws assembled as shown

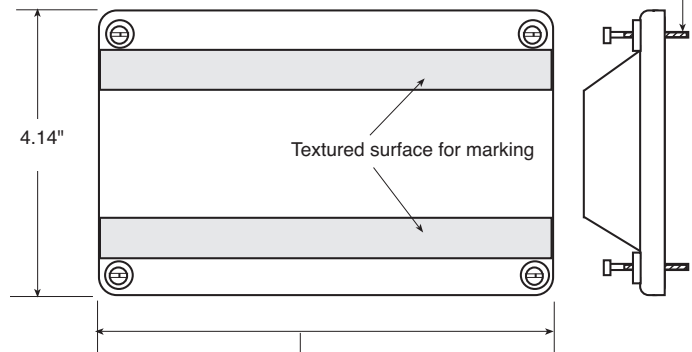

CPDB-1	(single pole)	2.10"
CPDB-2	(two pole)	3.72"
CPDB-3	(three pole)	5.34"

Dimensions

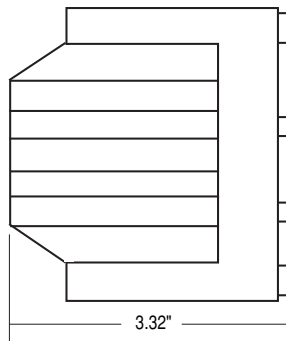
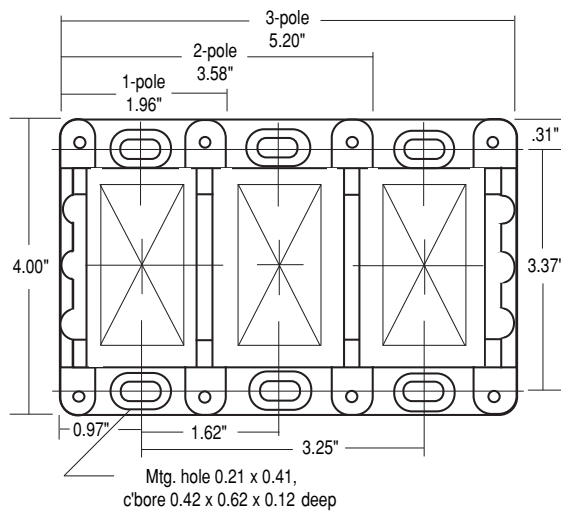



















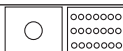

(See following page for ratings)

Data Sheet: 1049

Catalog numbers

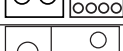
Basic

catalog numbers	Wire size (poles) lineside	(poles) loadside	Amps/pole	Line/load
16301*	250kcmil-6 AWG Cu only	250kcmil-6 AWG Cu only	255	
16303	350kcmil-6 AWG Cu-Al	350kcmil-6 AWG Cu-Al	310	
16306	500kcmil-6 AWG Cu-Al	500kcmil-6 AWG Cu-Al	380	
16321**	2/0-14 AWG CU, 2/0-8Al	(6)4-14 AWG Cu, 4-8 AWG Al	175	
16323**	350kcmil-6 AWG Cu-Al	(6)4-14 AWG Cu, 4-12 AWG Al	310	
16325	(2)2/0-14 AWG Cu, 2/0-8 AWG Al	(6)4-14 AWG Cu, 4-8 AWG Al	350	
16330	500kcmil-6 AWG Cu-Al	(6) 2-14 AWG Cu, 2-12 AWG Al	380	
16332	350kcmil-6 AWG Cu-Al	(3) 2-14 AWG Cu, 2-8 AWG Al (2) 1/0-14 AWG Cu, 1/0-8 AWG Al	310	
16335	500kcmil-6 AWG Cu-Al	(3) 2-14 AWG Cu, 2-8 AWG Al (2) 1/0-14 AWG Cu, 1/0-8 AWG Al	380	
16370**	350kcmil-6 AWG Cu-Al	(12)4-14 AWG Cu, 4-12 AWG Al	310	
16371**	350kcmil-6 AWG Cu-Al	(6) 2-14 AWG Cu, 2-8 AWG Al (3) 1/0-14 AWG Cu, 1/0-8 AWG Al	310	
16372	350kcmil-6 AWG Cu-Al	(21) 10-14 AWG Cu, 10 AWG Al	310	
16373	350kcmil-6 AWG Cu-Al	(14) 10-14 AWG Cu, 10 AWG Al (3) 1/0-14 AWG Cu-Al	310	
16375	600kcmil-2 AWG Cu-Al	(12)4-14 AWG Cu, 4-12 AWG Al	420	
16376	600kcmil-2 AWG Cu-Al	(6) 2-14 AWG Cu, 2-8 AWG Al (3) 1/0-14 AWG Cu, 1/0-8 AWG Al	420	
16377	(2)300kcmil-4 AWG Cu-Al	(12)4-14 AWG Cu, 4-12 AWG Al	570	
16378	500kcmil-6 AWG Cu-Al	Stud size (2) 1/4-20 x 1	380	
16383	500kcmil-6 AWG Cu-Al	Stud size (1) 3/8-16 x 1	380	
16390	3/8-16 x 1 1/8 stud size	3/8-16 x 1 1/8 stud size	250	
16394	1/2-13 x 1 1/16 stud size	1/2-13 x 1 1/16 stud size	400	
16395	3/8-16 x 1 1/16 stud size	(2) 1/4-20 x 3/16 stud size	310	

*Copper connectors for use with copper wire only.

**SCCR up to 200kA

Ordering information

163 blocks are available in 1-, 2- or 3-poles. To order: basic catalog number + number of poles.

Examples: 16301-1 = one-pole block
 16301-3 = three-pole block

11675

Specifications

Description: Screw connection line side, (3) 0.250" quick-connect load side power terminal block.

Poles: 2- to 12-poles.

Wire range: 8 – 14 AWG Cu.

Ratings: Volts: — 250Vac/dc

Amps: — Up to 40A

SCCR: — 10kA per UL 508A table SB4.1

Agency information: CE, Guide XCFR2, UL E62622; CSA 47235.

Torque rating: 9 lb-in max.

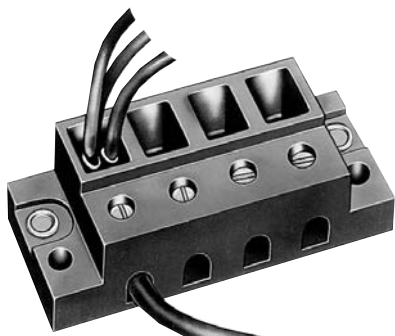

Catalog numbers

Catalog numbers	Poles	Catalog numbers	Poles
11675-2	2	11675-8	8
11675-3	3	11675-9	9
11675-4	4	11675-10	10
11675-5	5	11675-11	11
11675-6	6	11675-12	12
11675-7	7		

11725

Specifications

Description: Screw connection line side, (4) 0.250" quick-connect load side power terminal block.

Poles: 2-, 3- or 4-poles.

Wire Range: 2 – 14 AWG Cu/8 AWG Al.

Ratings: Volts: — 600Vac/dc

Amps: — Up to 70A

SCCR: — 10kA per UL 508A table SB4.1

Agency Information: CE, UL Guide XCFR2, E62622; CSA 47235.

Torque Rating: 45 lb-in max.



Catalog Numbers

Catalog Numbers	Poles
11725-2	2
11725-3	3
11725-4	4

160, 162, 163 and 165

Specifications

Description: Power terminal blocks.

Construction: Molded black thermoplastic.

Wire range: See catalog numbers table.

Poles: 160: 2-, 3- or 4-poles
162, 163 and 165: 1-, 2- or 3-poles

Ratings: Volts: — 600Vac/dc

Amps: — Up to 1520A

SCCR: — 10kA per UL 508A table SB4.1 (except for select products noted in table)

Agency information: CE, Guide XCFR2, UL E62622 General Industrial Class per UL 1059; CSA Class 6228-01, File 53787.

Flammability rating: UL 94V0.

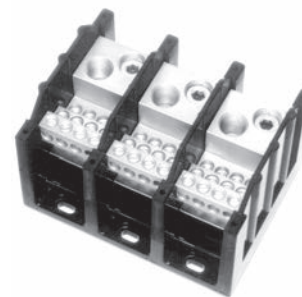

Catalog numbers

Catalog numbers	Line connection	Load connection	Connector material & ampacity	Agency information
16021*	2/0-#14Cu, 2/0-#8Al	(6)#4-#14Cu, #4-#8Al	175A	UL/CSA
16023*	350kcmil-#6Cu/Al	(6)#4-#14Cu, #4-#12Al	310A	UL/CSA
16220**	2/0-#14Cu, 2/0-#8Al	(4)#4-#14Cu, #4-#8Al	175A	UL/CSA
16321**	2/0-#14Cu, 2/0-#8Al	(6)#4-#14Cu, #4-#8Al	175A	UL/CSA
16323**	350kcmil-#6Cu/Al	(6)#4-#14Cu, #4-#12Al	310A	UL/CSA
16325	(2)2/0-#14Cu, 2/0-#8Al	(6)#4-#14Cu, #4-#8Al	350A	UL/CSA
16330	500kcmil-#6Cu/Al	(6)#2-#14Cu, #2-#12Al	380A	UL/CSA
16332	350kcmil-#6Cu/Al	(3)#2-#14Cu, #2-#8Al	310A	UL/CSA
		(2)1/0-#14Cu, 1/0-#8Al		
16335	500kcmil-#6Cu/Al	(3)#2-#14Cu, #2-#8Al	380A	UL/CSA
		(2)1/0-#14Cu, 1/0-#8Al		
16370**	350kcmil-#6Cu/Al	(12)#4-#14Cu, #4-#12Al	310A	UL/CSA
16371**	350kcmil-#6Cu/Al	(6)#2-#14Cu, #2-#8Al	310A	UL/CSA
		(3)1/0-#14Cu, 1/0-#8Al		
16372	350kcmil-#6Cu/Al	(21)#10-#14Cu, #10Al	310A	UL/CSA
16373	350kcmil-#6Cu/Al	(3)1/0-#14Cu/Al	310A	UL/CSA
		(14)#10-#14Cu, #10Al		
16375	600kcmil-#2Cu/Al	(12)#4-#14Cu, #4-#12Al	420A	UL/CSA
16376	600kcmil-#2Cu/Al	(6)#2-#14Cu, #2-#8Al	420A	UL/CSA
		(3)1/0-#14Cu, 1/0-#8Al		
16377	(2)300kcmil-#4Cu/Al	(12)#4-#14Cu, #4-#12Al	570A	UL/CSA
16400	(4)500kcmil-#6Cu/Al	(22)#2-#14Cu/Al	1520A	UL/CSA
16528	(2)600kcmil-#2Cu/Al	(4)3/0-#6Cu/Al	840A	UL/CSA
		(4)#4-#14Cu/Al		
16530	(2)500kcmil-#6Cu/Al	(12)#4-#14Cu/Al	760A	UL/CSA
16541	(1)500kcmil-#6Cu/Al	(21)#6-#14Cu/Al	380A	UL/CSA

*160 bases have mounting holes outside the barriers. Other bases (162 through 165) have mounting holes within barriers. See Data Sheet for dimensional drawings.

**SCCR up to 200kA

How to order

Catalog number + # of poles

Example: 16021 – 3 (complete part number)

Optional covers:

- 160: CPB160 - (pole)
- 162: CPB162 - (pole)
- 163: CPDB- (pole)
- 165: CPDB165 (1 for each pole)

Data Sheets: 1117 (160, 162, 165); 1148 (163)