

CLASS J 600 Volt Fuse Blocks















Mersen Class J fuse blocks accommodate all Class J fuses.

A choice of screw, pressure plate, box and special order stud connectors fit a wide range of stranded or solid copper or aluminum conductors. Insulators are either molded glass-filled polycarbonate (GFPC) or phenolic with verified dielectric strength in excess of 2500V. 30A, 60A and the new 100A SJ fuse blocks feature a unique adder block configuration which can be snapped onto 1-, 2-, or 3-pole blocks to form multi-pole segmented blocks of as many poles as desired. All fuse clips are made of high conductivity tin-plated copper, with a choice of spring-reinforced or non-spring reinforced clips. Space saving options are now available in the 30A and 100A configurations which are noted in the product selection tables.

Recommended Fuse Usage:

- Class J Blocks (600V) use with AJT, A4J, HSJ

Clip & Connector Types:

30A & 60A Clips	Connectors	Connectors	Connectors	Connectors
Spring Reinforced 	Non-spring Reinforced 30A & 60A Box 	Spring Reinforced 30A & 60A Box 	Spring Reinforced 100A Box 	Spring Reinforced 400A Box Side Clip 
Non-spring Reinforced 	Non-spring Reinforced 30A Screw 	Spring Reinforced 30A Screw 	Spring Reinforced 100A Box Side Clip 	Spring Reinforced 400A Box In-line Clip 
	Non-spring Reinforced 30A Pressure Plate 	Spring Reinforced 30A Pressure Plate 	Spring Reinforced 200A Box Side Clip 	Spring Reinforced 600A Box In-line Clip 



Ratings:

Volts : 600VAC / DC

Amps : 30A, 60A, 100A,
: 200A, 400A, 600A

SCCR : 200kA

Approvals:

- All class J fuse blocks meet the requirements of UL4248 (formerly UL512)
- UL listed Guide IZLT, File E52283
- CSA certified class 6225, File 32169



CLASS J 600 Volt Fuse Blocks

600 Volt, 200, 400 & 600 Ampere Class J Fuse Blocks

Ampere Rating	Poles	Connectors		Catalog Number	Connector Torque In - lb
		Type	Wire Range	Spring Reinforced	
100 GFCP Insulator	Adder			61005SJ	
	1	Box	Al/Cu	61006SJ	100 (Al)
	2	Side Clip	2/0-#6	61007SJ	60 (Cu)
	3			61008SJ	
	1	Box	Al/Cu	61036J	120
	2		2/0-#6	61037J	
	3			61038J	
	1	Box	Cu*	61006J	50
	2		2/0-#12	61007J	
3			61008J		

Dimensions for 100A Space Saving "SJ" Style Fuse Blocks

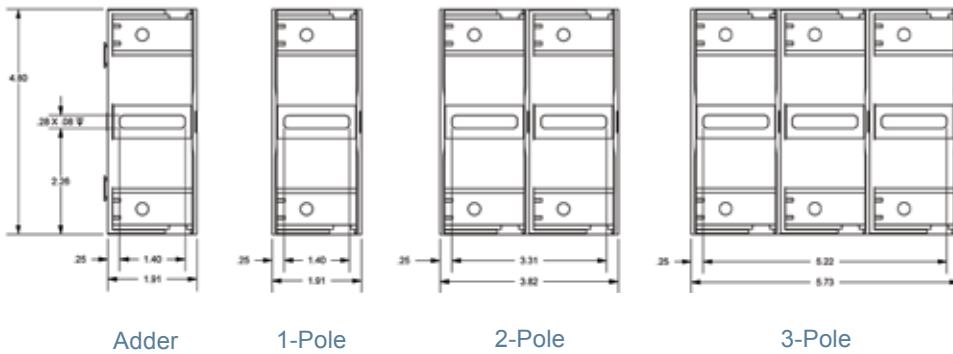

Dimensions for 100A Standard Class J Style Fuse Blocks

