

22MM METAL ROUND ACTUATOR: PUSHBUTTON WITH FLAT  
BUTTON WITH HOLDER BLACK SOLVENT-RESISTANT



Design of the product	Single device round
<b>Enclosure:</b>	
Number of command points	1
<b>Actuator:</b>	
Design of the operating mechanism	Pushbutton
Manner of function of the actuating element	Momentary contact type
Product extension optional Light source	No
Color	
• of the actuating element	black
Material of the actuating element	plastic
Shape of the actuating element	Flat pushbutton
Outer diameter of the actuating element	28.5 mm
Type of unlocking device	without
Number of switching positions	2
<b>Front ring:</b>	
Product component front ring	Yes
Design of the front ring	Standard
Material of the front ring	metal

<b>Color of the front ring</b>	silver
--------------------------------	--------

### Holder:

<b>Material of the holder</b>	Metal
-------------------------------	-------

### General technical data:

<b>Product function</b>	
• EMERGENCY OFF function	No
• EMERGENCY STOP function	No
<b>Protection class IP</b>	IP67
<b>Vibration resistance</b>	
• acc. to IEC 60068-2-6	20 ... 200 Hz: 5g
<b>Operating frequency maximum</b>	1 000 1/h
<b>Mechanical service life (switching cycles)</b>	
• typical	10 000 000
<b>Equipment marking</b>	
• acc. to DIN 40719 extended according to IEC 204-2 acc. to IEC 750	S
• acc. to DIN EN 61346-2	S
• acc. to DIN EN 81346-2	S

### Connections/ Terminals:

<b>Tightening torque of the screws in the bracket</b>	1 N·m
-------------------------------------------------------	-------





### Ambient conditions:

<b>Ambient temperature</b>	
• during operation	-25 ... +70 °C
• during storage	-40 ... +80 °C
<b>Environmental category during operation acc. to IEC 60721</b>	3K6

### Installation/ mounting/ dimensions:

<b>Mounting type</b>	front mounting
<b>Shape of the installation opening</b>	round
<b>Mounting diameter</b>	22 mm

### Certificates/approvals

General Product Approval			Declaration of Conformity	Test Certificates	Shipping Approval
 CSA	 UL		 EG-Konf.	<a href="#">spezielle Prüfbescheinigungen</a> <u>n</u>	 ABS

Shipping Approval				other	
 DNV	 LRS	 PRS	 RINA	<a href="#">Bestätigungen</a>	<a href="#">sonstig</a>

other
<a href="#">Umweltbestätigung</a>

### Further information

**Information- and Downloadcenter (Catalogs, Brochures,...)**

<http://www.siemens.com/industrial-controls/catalogs>

**Industry Mall (Online ordering system)**

<https://mall.industry.siemens.com/mall/en/en/Catalog/product?mlfb=3SB35000AA11>

**Cax online generator**

<http://support.automation.siemens.com/WW/CAXorder/default.aspx?lang=en&mlfb=3SB35000AA11>

**Service&Support (Manuals, Certificates, Characteristics, FAQs,...)**

<https://support.industry.siemens.com/cs/ww/en/ps/3SB35000AA11>

**Image database (product images, 2D dimension drawings, 3D models, device circuit diagrams, EPLAN macros, ...)**

[http://www.automation.siemens.com/bilddb/cax\\_de.aspx?mlfb=3SB35000AA11&lang=en](http://www.automation.siemens.com/bilddb/cax_de.aspx?mlfb=3SB35000AA11&lang=en)

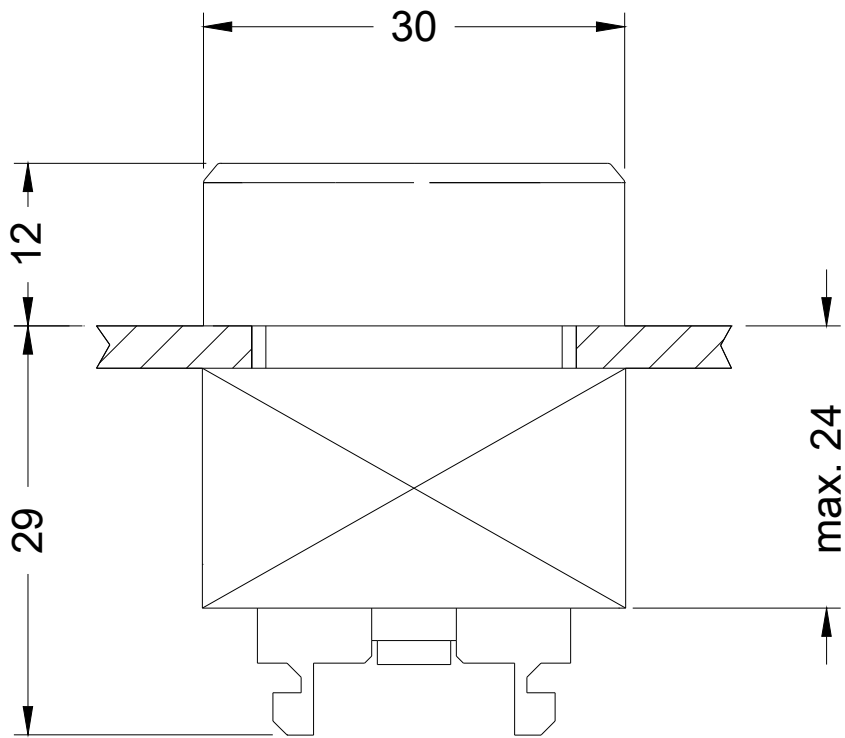

last modified:

31.03.2016