

CAB® Bosserman Clips

CAB Bosserman Clips are widely respected for their superior ability to safely suspend electrical cables and wiring in a variety of underground applications. CAB Bosserman Clips feature a 100% plastisol coated high tensile spring steel body and locking arm to prevent pull out and slippage. This improved hanger combines all the advantages of steel and plastic for the highest level of performance and safety underground.



Bosserman Clips keep cables safely up and out of the way of moving equipment.



The Bosserman Clip is CAB's strongest, most corrosion resistant mine hanger.



Bosserman Clip
CAB 814 - 820
CAB 821 - 828
CAB 950 - 956



Advantages of Bosserman Clips

1. Corrosion and rust problems are virtually eliminated due to the heavy plastisol coating over the entire metal surface of the Bosserman Clip. This rustproofing protection will outlast other typical methods of rustproofing and will result in significant cost savings and improved safety.
2. Slippage of hangers on the messenger wire is no longer a problem due to the slip resistance of the plastisol in the attachment section of the clip. Uniform spacing of hangers without this slippage will keep wires more safely up and out of the way.
3. High dielectric grade plastisol applied on 100% of the hanger surface makes the Bosserman Clip totally insulated and spark resistant. Provides for maximum safety in the suspension of electric cables and wiring in all underground applications.
4. Extra Long Styles available for running 2 cables separately from 1 messenger wire or large bundles of cables. Also available with 1" (25mm) wide saddles in the cable carrying section for extra support of cables.

Bosserman Clip 1/4" (6mm) Lock

- CAB 814** 1" (25mm) dia., 200/box, 13 lbs. (5.9kg)
- CAB 815** 2" (51mm) dia., 100/box, 13 lbs. (5.9kg)
- CAB 816** 3" (76mm) dia., 50/box, 9 lbs. (4.1kg)
- CAB 817** 4" (102mm) dia., 50/box, 16 lbs. (7.3kg)
- CAB 818** 5" (127mm) dia., 25/box, 9 lbs. (4.1kg)
- CAB 819** 6" (152mm) dia., 25/box, 10 lbs. (4.5kg)
- CAB 820** 8" (203mm) dia., 25/box, 13 lbs. (5.9kg)

Bosserman Clip 3/8" (10mm) Lock

- CAB 821** 1" (25mm) dia., 200/box, 13 lbs. (5.9kg)
- CAB 822** 2" (51mm) dia., 100/box, 13 lbs. (5.9kg)
- CAB 823** 3" (76mm) dia., 50/box, 9 lbs. (4.1kg)
- CAB 824** 4" (102mm) dia., 50/box, 16 lbs. (7.3kg)
- CAB 825** 5" (127mm) dia., 25/box, 9 lbs. (4.1kg)
- CAB 826** 6" (152mm) dia., 25/box, 10 lbs. (4.5kg)
- CAB 828** 8" (203mm) dia., 25/box, 13 lbs. (5.9kg)

Bosserman Clip 1/2" (13mm) Lock

- CAB 950** 1" (25mm) dia., 200/box, 13 lbs. (5.9kg)
- CAB 951** 2" (51mm) dia., 100/box, 13 lbs. (5.9kg)
- CAB 952** 3" (76mm) dia., 50/box, 9 lbs. (4.1kg)
- CAB 953** 4" (102mm) dia., 50/box, 16 lbs. (7.3kg)
- CAB 954** 5" (127mm) dia., 25/box, 9 lbs. (4.1kg)
- CAB 955** 6" (152mm) dia., 25/box, 10 lbs. (4.5kg)
- CAB 956** 8" (203mm) dia., 25/box, 13 lbs. (5.9kg)

For total corrosion resistance and insulation in above ground applications, use CAB Rings which are outlined on page 14.

CAB® Telewire Hooks

For safe support of electrical, control, communication or sensor wires.
Can be driven into timber or hung from roof bolt plates, chain, spads or cable.
Pigtail and closed loop designs offer additional safety and prevent wires from accidentally coming out of the hanger.

CAB Drive-In Telewire Hooks

Designed to be installed without a nail. Hooks have a sharp point for driving and an offset opening to prevent wires from accidentally coming out of the hook.

Packaged 200/box.

CAB 342 3/4" (19mm) dia., .156 (4mm) wire, 10 lbs. (4.5kg)

CAB 296 1-1/4" (32mm) dia., .187 (4.7mm) wire, 15 lbs. (6.8kg)

CAB 334 1-1/4" (32mm) dia., .156 (4mm) wire, 12 lbs. (5.5kg)

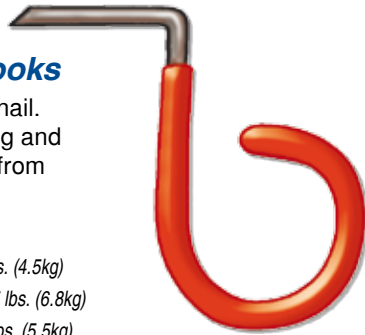

CAB 297 Telewire Hooks

Designed for installation from spad, roof bolt plate or chain. Offset opening helps retain wire in hook. Made from .187 (4.7mm) wire with 3/8" (10mm) diameter top loop offset 90° to 1-1/4" (32mm) bottom carrier.

CAB 297 1-1/4" (32mm) dia., 200/box, 15 lbs. (6.8kg)



CAB Drive-In Closed Loop Hooks

Feature a 540° insulated spiral loop which virtually guarantees that wiring will be safely retained and not accidentally vibrate or jump out of the hook. Easily installed with sharp tip drive-in point. Made from .156 (4mm) wire.

CAB 911 1-1/4" (32mm) dia., 100/box, 11 lbs. (5kg)

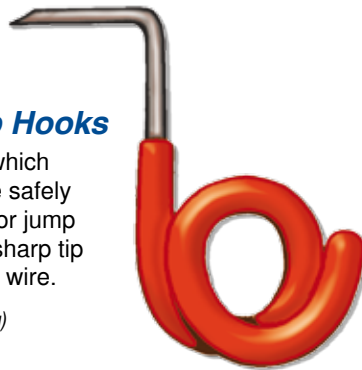

CAB 302, 311 Telewire Hooks

These J-Hooks are useful for a wide variety of hanging jobs. Can be installed from chain, roof bolt plates, spads, etc. 3/8" (10mm) diameter top loop offset 90° to 1-1/4" (32mm) carrier section. Offered in 2 wire gauges. Packaged 200/box.

CAB 302 1-1/4" (32mm) dia., .187 (4.7mm) wire, 16 lbs. (7.3kg)

CAB 311 1-1/4" (32mm) dia., .156 (4mm) wire, 11 lbs. (5kg)



CAB Closed Loop Telewire Hooks

Closed loop design prevents wires from vibrating or jumping out of the carrier section of the hook. Made from .156 (4mm) wire with 1/2" (13mm) diameter top loop offset 90° to carrier section.

CAB 908 1" (25mm) dia., 200/box, 15 lbs. (6.8kg)

CAB 912 1-1/4" (32mm) dia., 100/box, 10 lbs. (4.5kg)

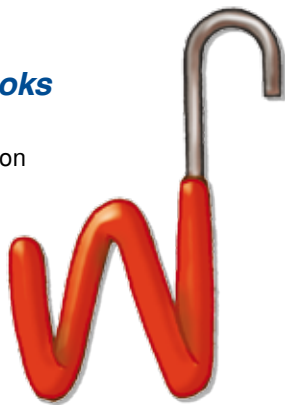

CAB Jumbo Telewire Hooks

Extra capacity hooks made for those large jobs. Features same design as the popular 297 and 311 but have larger overall dimensions. Made from sturdy .187 (4.7mm) wire with a 5/8" (16mm) diameter top loop set at 90° to bottom carrier. Packaged 200/box. Available in 2 sizes.

CAB 223 1-5/8" (41mm) dia., 17 lbs. (7.7kg)

CAB 219 2" (51mm) dia., 19 lbs. (8.6kg)



CAB 340, 341 Telewire Hooks

S-Style hook features 5/8" (16mm) diameter top loop and 1-1/4" (32mm) diameter carrier loop. CAB 340 same as 341 except attachment loop set 90° to carrying area. Made from .156 (4mm) wire.

CAB 340 1-1/4" (32mm) dia., 200/box, 11 lbs. (5kg)

CAB 341 1-1/4" (32mm) dia., 200/box, 11 lbs. (5kg)



CAB 333, 339 Telewire Hooks

Feature a large 5/8" (16mm) diameter top attachment loop for easier installation. Offset opening retains wiring in support area. Available in 2 wire gauges. Packaged 200/box.

CAB 333 1-1/4" (32mm) dia., .156 (4mm) wire, 12 lbs. (5.5kg)

CAB 339 1-1/4" (32mm) dia., .187 (4.7mm) wire, 16 lbs. (7.3kg)

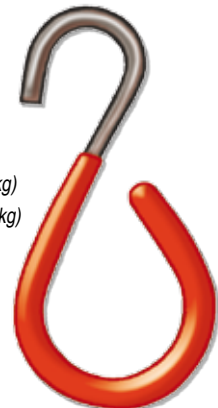

CAB® Multi Carrier Hooks

Safe system for organizing sensor, communication, control and electrical wiring. Especially useful along conveyor beltlines and when running multiple cables.

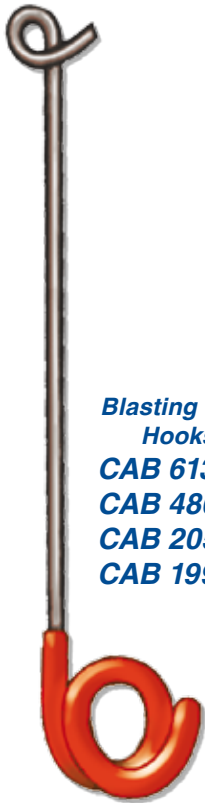

Blasting Wire Hooks
CAB 6130
CAB 4801
CAB 205
CAB 199

CAB Blasting Wire Hooks are designed to safely isolate blasting or other wiring from the roof, electrical cables or structure. A 7/8" (22mm) diameter 540° bottom loop securely retains wires in carrier. The 1/2" (13mm) top spiral loop design prevents dislodging of hanger after installation.

- CAB 6130** 4" (102mm) long, 100/box, 9 lbs. (4.1kg)
- CAB 4801** 6" (152mm) long, 100/box, 11 lbs. (5.0kg)
- CAB 205** 12" (305mm) long, 50/box, 7 lbs. (3.2kg)
- CAB 199** 18" (457mm) long, 100/box, 18 lbs. (8.2kg)



CAB 305 has four 1" (25mm) diameter closed spiral loops. 1/2" (13mm) diameter top loop has closed spiral design which prevents dislodging of hanger from beltline chain or other support after installation. .156 wire (4mm), 11-3/4" (298mm) long.

- CAB 305** 25/box, 11 lbs. (5.0kg)
- CAB 231*** 25/box, 11 lbs. (5.0kg)
- *Same as CAB 305 except with drive-in point for nail-in application.

CAB 4701 has three 3/4" (19mm) diameter carriers and 1/2" (13mm) diameter open top loop. CAB 809 is the same except has a drive-in point. 8" (203mm) long. Made from .156 (4mm) wire.

- CAB 4701** 50/box, 10 lbs. (4.5kg)
- CAB 809** 100/box, 15 lbs. (6.8kg)



CAB 4701

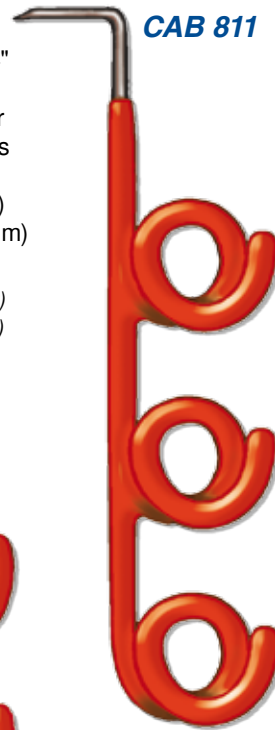

CAB 811



CAB 812
(side view)

CAB 811 and 812 feature three 1-1/4" (32mm) diameter closed loop carriers. CAB 812 has 1/2" (13mm) diameter top loop for installation from plates, spads or chain. The 811 has sharp tip drive-in point for easy nailing into wood structure. Made from .156 (4mm) wire, 10-5/8" (270mm) long. Packaged 25/box.

- CAB 811** 10 lbs. (4.5kg)
- CAB 812** 10 lbs. (4.5kg)

Put CAB Hangers to work in your mine!



CAB 910

CAB 910 features two 1" (25mm) diameter closed loop carriers. Ideal for above beltlines because of short 5-1/4" (133mm) length. .156 (4mm) wire with 1/2" (13mm) diameter top loop.

- CAB 910** 50/box, 9 lbs. (4.1kg)

CAB 813 Same design as 910 but features four 1-1/4" (32mm) diameter closed loop spirals which securely retain cables in hanger. Overall length 11" (279mm).

- CAB 813** 40/box, 19 lbs. (8.6kg)



CAB Telewire Bars

CAB Telewire Bars are heavy duty multi-carrier hangers for roof installations. Top section made from .180" x 1" (4.6 x 25.4mm) safety edge steel and 5/16" (7.9mm) round stock. Bottom carriers made any diameter in closed loop (pictured) or open loop designs. Can be made with 1 to 10 carriers, custom to your specifications.

CAB® Rope Hangers

Versatile hangers designed to support hose, pipe and cables in many applications. Made from 1/4" (6.4mm) flame retardant, hollow braid polypropylene rope with strong .208" (5.3mm) dia. galvanized wire hooks.

Rope Hanger
CAB 3832

Rope Hanger
CAB 988

CAB Rope Hangers are offered in any length, with any number of hooks, including heavy duty .250" (6.4mm) diameter galvanized wire hooks. Rope Hangers primarily intended for temporary use. For permanent cable support, insulated steel hangers are recommended. Standard sizes listed below. Other sizes available.

- CAB 3708** 12" (305mm) long, .208 hook, 200/box, 13 lbs. (5.9kg)
- CAB 3709** 15" (381mm) long, .208 hook, 200/box, 14 lbs. (6.4kg)
- CAB 6012** 15" (381mm) long, .208 hook/2 ea., 200/box, 24 lbs. (10.9kg)
- CAB 6018** 15" (381mm) long, .250 HD hook, 200/box, 19 lbs. (8.6 kg)
- CAB 988** 18" (457mm) long, .208 hook, 200/box, 15 lbs. (6.8kg)
- CAB 3832** 18" (457mm) long, .208 hook/2 ea., 200/box, 24 lbs. (10.9kg)
- CAB 4972** 18" (457mm) long, .250 HD hook, 200/box, 20 lbs. (9.1kg)
- CAB 6673** 18" (457mm) long, .250 HD hook/2 ea., 100/box, 32 lbs. (14.5kg)
- CAB 5965** 20" (508mm) long, 1 strand .208 hook/2 ea., 100/box, 22 lbs. (10kg)
- CAB 990** 21" (533mm) long, .208 hook, 100/box, 9 lbs.(4.1kg)
- CAB 989** 24" (610mm) long, .208 hook, 100/box, 9 lbs. (4.1kg)
- CAB 991** 36" (914mm) long, .208 hook, 100/box, 11 lbs. (5kg)
- CAB 5042** 48" (1.2m) long, .208 hook, 100/box, 7 lbs. (3.2kg)
- CAB 5041** 60" (1.5m) long, .208 hook, 100/box, 7 lbs. (3.2kg)
- CAB 7313** 72" (1.8m) long, .208 hook, 100/box, 8 lbs. (3.6kg)
- CAB 7070** 96" (2.4 m) long, .208 hook, 100/box, 11 lbs. (5kg)

CAB MRS Collapsible Hangers



MRS Hanger
CAB 6698

CAB MRS Collapsible Hangers

are designed to hang cables when mining with mobile roof supports. For improved safety, bottom two carriers of hanger collapse, allowing cables to drop to floor of mine when tension is applied. Top loop retains hanger in mine roof after bottom carriers release. This allows miners to remove cables from hangers without entering unsupported roof hazard areas. Each carrier has a safe working load of 22 pounds (10.0kg). Equally loaded, each carrier will drop cables with a weight load or tension equivalent of 70-90 lbs. (31.8-40.9kg) Made from .187 (4.7mm) low tensile strength wire, 5/8" (16mm) diameter top loop, 2-1/2" (64mm) diameter bottom carriers.

Two Carrier Hanger:

CAB 6698 7-1/2" (191mm) long, 50/box, 11 lbs. (5kg)

Single Carrier Hanger:

CAB 219 4-1/2" (114mm) long, 200/box, 19 lbs. (8.6kg)

CAB Leaky Feeder Hangers

Leaky Feeder Hanger
CAB 7719



CAB Leaky Feeder Hangers

are designed to safely and securely hang leaky feeder cable from roof of mine. Can help to reduce interference and improve signal strength by adding spacing between steel mesh or roof structure and cable. Durable 1-1/2" (38mm) wide polypropylene webbing with heavy duty top hook. Quick and easy to use. Webbing snugs down on cable to provide safe 1-1/2" (38mm) wide surface area to hold cable firmly in position.

CAB 7719 10" (254mm) long, 100/box, 9 lbs. (4.1kg)

CAB 7720 15" (381mm) long, 100/box, 10 lbs. (4.5kg)

CAB 7721 20" (508mm) long, 100/box, 11lbs. (5kg)

CAB 903

CAB 905

CAB Plastic Telewire Hooks



CAB 904

Made from .085 x 1" (2.2 x 25.4mm) extruded PVC channel. Designed to hang from messenger wire or bellline structure. 5/8" (16mm) wide carriers. 15/16" (24mm) top hole. 1/4" (6.4mm) nylon nuts and bolts.

CAB 903 200/box, 8 lbs. (3.6kg)

CAB 904 with 90° offset, 200/box, 8 lbs. (3.6kg)

CAB 905 2 carrier, 50/box, 7 lbs. (3.2kg)

CAB 906 3 carrier, 50/box, 9 lbs. (4.1kg)

CAB 909 4 carrier, 50/box, 12 lbs. (5.5kg)

Safe, strong support for electrical cables, hoses and pipes. CAB J-Hooks are made from .180" x 1" (4.6 x 25.4 mm) safety edge steel, with a heavy coat of plastisol for added protection in higher voltage and heavier load applications. Keyhole feature useful for hanger adjustment or removal. Sizes up to 12" (305mm) diameter.

CAB® J-Hooks

CAB Standard J-Hooks

Safe, strong supports for sidewall applications. Keyhole has 1/2" (13mm) opening and 5/16" (8mm) slot. Made from safety edge steel.

- CAB 343** 1-1/2" (38mm) dia., 5-1/2" (140mm) long, 100/box, 47 lbs. (21.4kg)
- CAB 347** 3" (76mm) dia., 5-1/2" (140mm) long, 50/box, 29 lbs. (13.2kg)
- CAB 349** 4" (102mm) dia., 6-3/4" (171mm) long, 25/box, 18 lbs. (8.2kg)
- CAB 350** 5" (127mm) dia., 9-5/8" (244mm) long, 25/box, 23 lbs. (10.5kg)

CAB Double J-Hooks

For hanging multiple cables from roof. 3" (76mm) diameter hooks with 5/8" (16mm) diameter top loop. CAB 213 and 155 top loop made from .187 (4.7mm) diameter wire; CAB 156 and CAB 4691 from .250" (6.4mm) wire.

- CAB 213** 6" (152mm) long, 25/box, 31 lbs. (14.1kg)
- CAB 155** 12" (305mm) long, 25/box, 35 lbs. (15.9kg)
- CAB 156** 30" (762mm) long, 25/box, 41 lbs. (18.6kg)
- CAB 4691** 36" (914mm) long, 10/box, 40 lbs. (18.2kg)

CAB Side Mount Hangers

Heavy duty supports designed to carry multiple cables in high corrosive environments. Carriers are 3" (76mm) diameter. Can be custom made with any number or size carriers required.

- CAB 6958** 1 carrier, 8" (203mm) long, 25/box, 28 lb. (12.7kg)
- CAB 6959** 2 carrier, 14-1/2" (368mm) long, 10/box, 24 lb. (10.9 kg)
- CAB 5133** 3 carrier, 20" (508mm) long, 10/box, 32 lb. (14.5kg)
- CAB 6681** 4 carrier, 26" (660mm) long, 5/box, 22 lb. (10kg)
- CAB 6704** 4 carrier, 26" (660mm) long, custom heavy duty style

CAB Drive-In J-Hooks

Feature sharp tip for driving, an installation hole in the drive-in shaft and a special detent to resist pullout. Packaged 25/box.

- CAB 353** 3" (76mm) dia., 5" (127mm) long, 17 lbs. (7.7kg)
- CAB 462** 4" (102mm) dia., 7" (178mm) long, 21 lbs. (9.5kg)
- CAB 479** 5" (127mm) dia., 8" (203mm) long, 30 lbs. (13.6 kg)

CAB Stacked J-Hooks

Heavy duty 2-carrier hangers for supporting pipe and cables from roof, side or structure. Made from .180 x 1" (4.6 x 25.4mm) safety edge steel and .187 (4.7mm) high carbon wire. 1-3/8" (35mm) diameter top loop.

- CAB 965** 1-1/2" (38mm) dia., 9-1/2" (241mm) long, 25/box, 29 lbs. (12.3kg)
- CAB 966** 3" (76mm) dia., 13" (330mm) long, 10/box, 16 lbs. (7.3kg)
- CAB 6188** 3" (76mm) dia., 30" (762mm) long, 25/box, 44 lbs. (20.0kg)

CAB Loop Top J-Hooks

Made with 1-3/8" (35mm) diameter top loop for versatility in hanging from roof or other structure.

- CAB 928** 3" (76mm) dia., 6-1/2" (165mm) long, 50/box, 32 lbs. (14.5kg)
- CAB 4501** 4" (102mm) dia., 8" (203mm) long, 25/box, 20 lbs. (9.1kg)

Double
J-Hook
CAB 213
CAB 155
CAB 156
CAB 4691

Side Mount
Hanger
CAB 5133
CAB 6681
CAB 6704

Standard
J-Hook
CAB 343
CAB 347
CAB 349
CAB 350

Stacked J-Hook
CAB 965
CAB 966
CAB 6188

Drive-In
J-Hook
CAB 353
CAB 462
CAB 479

Loop Top
J-Hook
CAB 928
CAB 4501

CAB® J-Hooks with Extensions

Made from .180"x1" (4.6 x 25.4mm) wide safety edge steel with 1/4" (6.4mm) diameter round wire extension for easy installation. All carriers are 3" (76mm) diameter with heavy plastisol coating for protection of cables. Top loop is 1-1/2" (38mm) diameter. Single, double, triple and other configurations available.

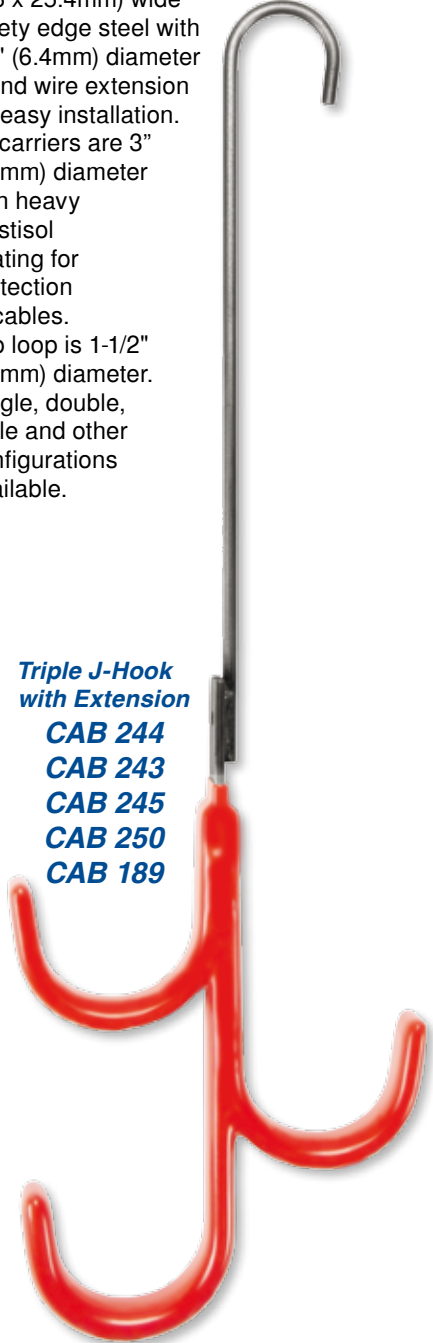

Triple J-Hook with Extension

- CAB 244**
- CAB 243**
- CAB 245**
- CAB 250**
- CAB 189**

1 Carrier:

- CAB 7379** 18" (457mm) long, 25/box, 22 lbs. (10kg)
- CAB 183** 36" (914mm) long, 25/box, 28 lbs. (12.7kg)

2 Carrier:

- CAB 7558** 30" (762mm) long, 25/box, 45 lbs. (20.5kg)

3 Carrier:

- CAB 244** 14" (356mm) long, 10/box, 22 lbs. (10kg)
- CAB 243** 24" (610mm) long, 10/box, 25 lbs. (11.4kg)
- CAB 245** 36" (914mm) long, 10/box, 27 lbs. (12.3kg)
- CAB 250** 48" (1.2m) long, 10/box, 30 lbs. (13.6kg)
- CAB 189** 72" (1.8m) long, 10/box, 31 lbs. (14.1kg)

CAB® Longwall Hangers

Heavy duty 8 carrier hanger designed to improve safety by organizing all types of cables and hoses used in longwall operations.

Longwall Hanger saves time and money because it is quick and easy to install and load with cables.

CAB's heavy plastic coating makes this hanger much safer to use than other types of fabricated bare metal hangers.

Made from sturdy .180" x 1" (4.6 x 25.4mm) safety edge steel with a strong 1/4" (6.4mm) diameter swivel hook at the top.

Also available with 12" (305mm) long extension hook at top for reduced lifting in higher roof areas. All carriers are 3" (76mm) diameter and totally coated with 90 mils (2.3mm) of high dielectric grade plastisol that has a 400-volt per mil (.03mm) dielectric breakdown strength. Coating is also very abrasion resistant and flame retardant.

CAB 154 24" (610mm) long, 10/box, 60 lbs. (27.3kg)

CAB 7406 34" (864mm) long, 10/box, 64 lbs. (29.1kg)

Available in 4 and 6 Carrier styles.

Also available with extensions for high roof areas.

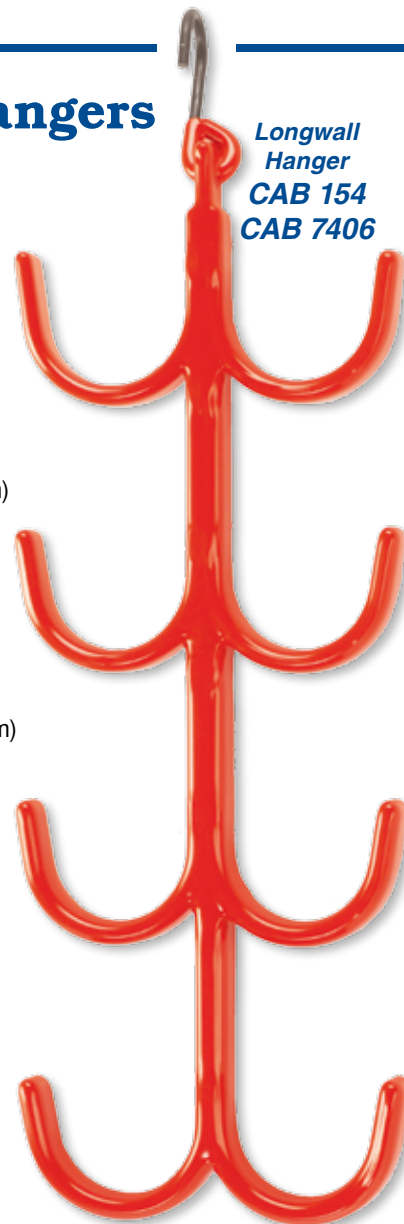

**Longwall Hanger
CAB 154
CAB 7406**



**Jumbo S-Hook
CAB 7338**

CAB Jumbo S-Hooks

Designed for all types of heavy duty hanging applications around the mine. Manufactured from strong 1/2" (13mm) diameter round stock with heavy plastisol coating over 100% of the surface. Large capacity 4-1/2" (114mm) diameter bottom carrier and 2-1/4" (57mm) top loop.

CAB 7338 10-1/2" (267mm) long, 10/box, 17 lbs. (7.7kg)

CAB U-Bolts

Made in a wide variety of sizes and styles to safely retain and bundle cables and hoses. Especially useful in longwall operations. Manufactured from any diameter threaded round stock with a heavy plastisol coating for maximum safety and protection. Contact CAB for standard sizes or to request custom dimensions. Nuts are optional.

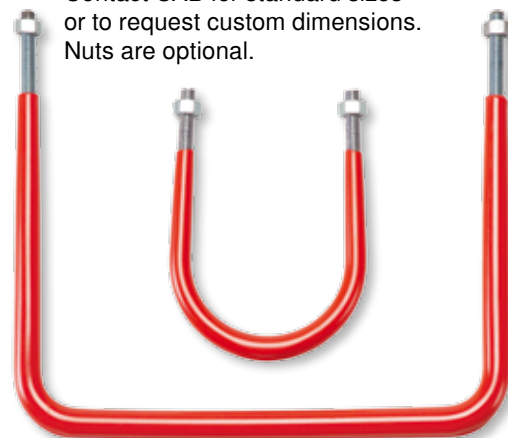

These CAB hangers are really tough! Plus we offer custom sizes and extensions.



CAB® Heavy Duty Round Stock Hangers

Designed To Carry Larger Loads

CAB Bullhorn Hangers

Heavy duty hangers made from strong 3/8" (10mm) diameter round stock with a 1/2" (13mm) diameter top loop. Bottom carriers are 5" (127mm) diameter, heavily coated with high dielectric grade plastisol for added safety and protection. Custom sizes available for high roof areas.

2 Carrier Bullhorn Hanger
CAB 143
CAB 144
CAB 141

CAB Bullhorn Hangers:

2 Carrier, top loop offset 90° to carrier:

CAB 143 18" (457mm) long, 10/box, 20 lbs. (9.1kg)

CAB 144 24" (610mm) long, 10/box, 21 lbs. (9.5kg)

CAB 141 30" (762mm) long, 10/box, 23 lbs. (10.5kg)

3 Carrier:

CAB 7628 19" (483mm) long, 15/box, 34lbs. (15.5kg)

4 Carrier:

CAB 7683 19" (483mm) long, 15/box, 41lbs. (18.6kg)

Also available with swivel top hook for faster installation.

4 Carrier Bullhorn Hanger
CAB 7683

CAB Super Duty Hangers

Made from strong 1/2" (13mm) diameter round stock to carry heavier loads. CAB 5653 is a 5-carrier hanger designed to handle heavy pipes, hoses and cables. Features three 3" (76mm) diameter and two 4" (102mm) diameter carriers with 2" (51mm) diameter top loop. Custom styles available.

CAB 5653 57" (1.4m) long

Super Duty Hanger
CAB 5653

CAB 228

CAB 228

Versatile 3 carrier hanger with 3" (76mm) diameter carriers. Made from strong 1/4" (6.4mm) diameter round wire with top spiral loop for secure attachment to plates, mesh or structure. Packaged 50/box.

CAB 228 1/2" (13mm) dia. top loop, 18" (457mm) long, 47 lbs. (21.4kg)

CAB 188 1-1/2" (38mm) dia. top loop, 18" (457mm) long, 47 lbs. (21.4kg)

CAB® Webbing Belts, Straps and Hangers

Strong and Versatile for Hanging All Types of Pipe and Cable

CAB Webbing Hangers

Made for the heavy-duty support of pipe and cable in underground mines and tunnels. Custom offset hooks are securely sewn into the ends of strong 1-1/2" (38mm) wide polypropylene webbing. Available with standard non-welded or heavy-duty welded hooks. Size measured from end of hooks with webbing fully extended. Common sizes listed below. Custom sizes available.

Standard 3/16" (5mm) Diameter Hooks:

- CAB 897** 15" (381mm) long, 100/box, 15 lbs. (6.8kg)
- CAB 898** 23" (584mm) long, 100/box, 16 lbs. (7.3kg)
- CAB 900** 30" (762mm) long, 50/box, 9 lbs. (4.1kg)
- CAB 902** 36" (914mm) long, 50/box, 10 lbs. (4.5kg)
- CAB 6820** 48" (1.2m) long, 50/box, 12 lbs. (5.5kg)

Heavy Duty Welded 3/16" (5mm) Diameter Hooks:

- CAB 893** 15" (381mm) long, 100/box, 15 lbs. (6.8kg)
- CAB 894** 23" (584mm) long, 100/box, 17 lbs. (7.7kg)
- CAB 895** 30" (762mm) long, 50/box, 9 lbs. (4.1kg)
- CAB 896** 36" (914mm) long, 50/box, 10 lbs. (4.5kg)
- CAB 6819** 48" (1.2m) long, 50/box, 13 lbs. (5.9kg)

CAB Double D-Ring Webbing Hangers

Strong, versatile hangers designed for supporting hose, pipe and cable in a variety of underground applications. Double D-rings allow for quick and easy adjustment of hanger length to keep lines at the desired height. Hanger made from 1-1/2" (38mm) wide orange polypropylene webbing. Top hook and D-rings welded and hot-dipped galvanized for extra strength and durability. Available in lengths of 2' to 20' (610mm to 6.1m) in 1' (305mm) increments. Common sizes listed below. For heavier loads use 1/4" (6.4mm) top hook. Size measured by overall length of webbing and hook before assembly.

Standard 3/16" (5mm) Diameter Top Hook:

- CAB 834** 2 ft. (610mm) long, 50/box, 10 lbs. (4.5kg)
- CAB 835** 3 ft. (914mm) long, 50/box, 11 lbs. (5kg)
- CAB 836** 4 ft. (1.2m) long, 50/box, 12 lbs. (5.5kg)
- CAB 837** 5 ft. (1.5m) long, 50/box, 13 lbs. (5.9kg)
- CAB 838** 6 ft. (1.8m) long, 50/box, 14 lbs. (6.3kg)

Heavy Duty 1/4" (6.4mm) Diameter Top Hook:

- CAB 844** 2 ft. (610mm) long, 50/box, 13 lbs. (5.9kg)
- CAB 845** 3 ft. (914mm) long, 50/box, 14 lbs. (6.4kg)
- CAB 846** 4 ft. (1.2m) long, 50/box, 16 lbs. (7.3kg)
- CAB 847** 5 ft. (1.5m) long, 50/box, 18 lbs. (8.2kg)
- CAB 848** 6 ft. (1.8m) long, 50/box, 20 lbs. (9.1kg)

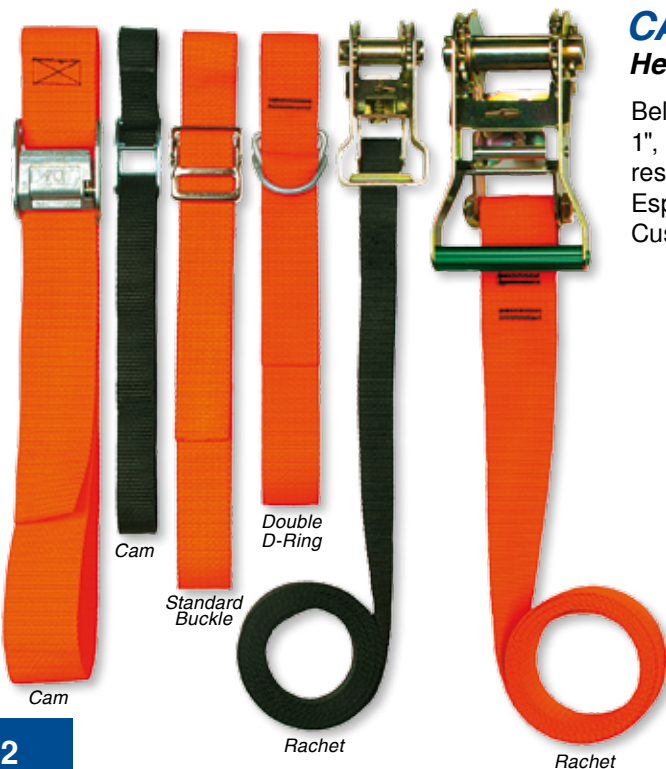

CAB Webbing Belts and Straps

Heavy Duty Styles for Bundling Hoses and Cables

Belts made from black or orange polypropylene webbing in three widths: 1", 1-1/2" or 2" (25mm, 38mm or 51mm). Choice of high quality corrosion resistant buckles in Double-D, Standard, Cam and Ratchet styles. Especially useful in longwall applications. Common sizes listed below. Custom sizes available.

Cam Buckle:

- CAB 6127** 1" x 2 ft. (25mm x 610mm) long, 50/box, 6 lbs. (2.7kg)
- CAB 6995** 1" x 3 ft. (25mm x 914mm) long, 50/box, 8 lbs. (3.6kg)
- CAB 7299** 1" x 4 ft. (25mm x 1.2m) long, 50/box, 9 lbs. (4.1kg)
- CAB 3707** 2" x 4 ft. (51mm x 1.2m) long, 25/box, 18 lbs. (8.2kg)

Standard Buckle:

- CAB 3715** 1-1/2" x 4 ft. (38mm x 1.2m) long, 50/box, 9 lbs. (4.1kg)

Double-D Ring Buckle:

- CAB 852** 1-1/2" x 2 ft. (38mm x 610mm) long, 50/box, 8 lbs. (3.6kg)
- CAB 853** 1-1/2" x 3 ft. (38mm x 914mm) long, 50/box, 9 lbs. (4.1kg)
- CAB 854** 1-1/2" x 4 ft. (38mm x 1.2m) long, 50/box, 10 lbs. (4.5kg)
- CAB 855** 1-1/2" x 5 ft. (38mm x 1.5m) long, 50/box, 11 lbs. (5kg)

Ratchet Style:

- CAB 3827** 1" x 12 ft. (25mm x 3.7m) long, 25/box, 25 lbs. (11.4kg)
- CAB 6960** 2" x 6 ft. (51mm x 1.8m) long, 10/box, 25 lbs. (11.4kg)
- CAB 6472** 2" x 12 ft. (51mm x 3.7m) long, 10/box, 28 lbs. (12.7kg)

CAB® Vent Tube Hangers

Safer, Easier to Install and More Cost Effective than Chain or Tie Wire



**Webbing Vent Tube Hanger
CAB 838**

**Wire Reinforced Webbing Vent Tube Hanger
CAB 7286
CAB 6570**

**Webbing Vent Tube Hanger without Wire Insert
CAB 7866**

**Rope Vent Tube Hanger
CAB 6469
CAB 6686**

CAB offers three styles of high quality hangers designed to safely suspend vent tubing. All are easier to use, more cost effective and safer than chain or tie wire. Webbing styles are made from 1-1/2" (38mm) wide polypropylene webbing with two heavy duty 1/4" (6.4mm) S-hooks and quick release buckle for easy adjustment.

Longer styles available with wire inserts sewn in the webbing for easy hook up in high roof areas. Rope style has spliced S-hook on one end and floating hook with line tightener on other end. After installation of hooks, tightener is easily adjusted on rope for proper positioning of vent tubing. Available in 1/4" (6.4mm) and 5/16" (8mm) diameter rope styles. Sizes measured by overall length fully extended. Custom sizes available.

Webbing Style Hangers:

- CAB 838** 6 ft. (1.8m) long, 50/box, 16 lbs. (7.3kg)
- CAB 7286** 8 ft. (2.4m) long, 15" (381mm) wire insert, 25/box, 19 lbs. (8.6kg)
- CAB 6570** 8 ft. (2.4m) long, 21" (533mm) wire insert, 25/box, 19 lbs. (8.6kg)
- CAB 7866** 6 ft. (1.8m) long, no wire insert, 25/box, 15 lbs. (6.8kg)

Rope Style Hangers:

- CAB 6469** 1/4" (6.4mm) rope, 10 ft. (3m) long, 25/box, 7 lbs. (3.2kg)
- CAB 6686** 5/16" (8mm) rope, 10 ft. (3m) long, 25/box, 12 lbs. (5.5kg)

CAB® Lifeline Hangers

Designed to Securely Hang Rope or Aircraft Cable Lifeline at Desired Height in Any Mine



Elastic

Aircraft Cable

Rope

Rope Quick Release

Rope and Aircraft Cable Hangers quickly attach to lifeline and have a strong hook for attachment to plates, mesh or roof structure. Elastic hangers are especially useful in crosscuts; they stretch 5 times their original length to lower lifeline during use and return it to original height after use. Quick-Release Hangers have a release pin that attaches to hanger hole or edge of plate. They can be quickly pulled off plates to drop lifeline for emergency escape. Standard sizes listed below. Custom and longer sizes available.

Elastic Lifeline Hangers:

- CAB 7335** 1 ft. (305mm) long, 25/box, 4 lbs. (1.8kg)
- CAB 7332** 2 ft. (610mm) long, 25/box, 5 lbs. (2.3kg)
- CAB 7336** 3 ft. (914mm) long, 25/box, 6 lbs. (2.7kg)
- CAB 7337** 4 ft. (1.2m) long, 25/box, 6 lbs. (2.7kg)

Aircraft Cable Lifeline Hangers:

- CAB 7165** 1 ft. (305mm) long, 25/box, 5 lbs. (2.3kg)
- CAB 7166** 2 ft. (610mm) long, 25/box, 6 lbs. (2.7kg)
- CAB 7167** 3 ft. (914mm) long, 25/box, 7 lbs. (3.2kg)
- CAB 7168** 4 ft. (1.2m) long, 25/box, 8 lbs. (3.6kg)
- CAB 7169** 5 ft. (1.5m) long, 25/box, 9 lbs. (4.1kg)
- CAB 7170** 6 ft. (1.8m) long, 25/box, 10 lbs. (4.5kg)

Rope Loop Lifeline Hangers:

- CAB 3708** 1 ft. (305mm) long, 200/box, 14 lbs. (6.4kg)
- CAB 989** 2 ft. (610mm) long, 100/box, 9 lbs. (4.1kg)
- CAB 991** 3 ft. (914mm) long, 100/box, 12 lbs. (5.5kg)
- CAB 5042** 4 ft. (1.2m) long, 50/box, 7 lbs. (3.2kg)
- CAB 5041** 5 ft. (1.5m) long, 50/box, 8 lbs. (3.2kg)
- CAB 7313** 6 ft. (1.8m) long, 50/box, 8 lbs. (3.6kg)

Rope Quick Release Lifeline Hangers:

- CAB 7684** 1 ft. (305mm) long, 100/box, 2 lbs. (0.9kg)
- CAB 7685** 2 ft. (610mm) long, 100/box, 3 lbs. (1.4kg)
- CAB 7686** 3 ft. (914mm) long, 100/box, 3 lbs. (1.4kg)
- CAB 7687** 4 ft. (1.2m) long, 100/box, 4 lbs. (1.8kg)
- CAB 7688** 5 ft. (1.5m) long, 100/box, 5 lbs. (2.3kg)
- CAB 7689** 6 ft. (1.8m) long, 100/box, 5 lbs. (2.3kg)



CAB Aircraft Cable Hanger with CAB Lifeline Marker



CAB Rope Hanger with CAB Lifeline Marker

Additional rope hangers on page 8.

CAB® Cable Rings & Saddles

Industry Favorite for Safe, Strong Support of Aerial Cables

CAB Cable Rings provide maximum strength and safety for the support of all types of aerial cables. Rings are manufactured from galvanized steel, copper clad steel or type 316 stainless steel to withstand the most corrosive environments. For added safety and protection, any style ring can be totally insulated with a tough, 80 mil (2mm) coating of high dielectric grade PVC plastisol.



CAB PVC coated Rings and Saddles are extremely resistant to corrosion and act as a mini-cable tray system for cables.

For maximum strength, CAB Cable Rings are manufactured from high tensile spring steel in rolled flat wire form. This high quality material provides a smooth, flat surface for the support of cables and rounded edges for the protection of cable jackets. This advanced roll-form design, combined with the strong spring temper of the wire, provides a tight, secure attachment of the cable ring to the messenger wire.

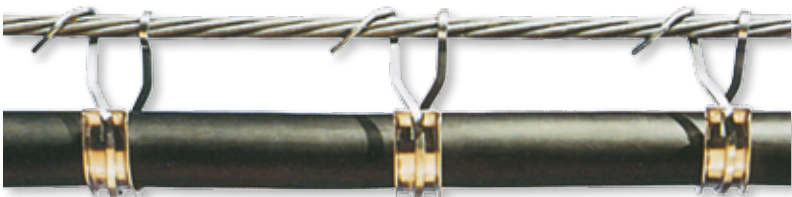

CAB Cable Ring Saddles provide a 1" wide load-bearing area for extra support and protection of cables.

CAB Cable Rings are manufactured in standard, medium and long styles. Designed to tightly fit on an exact messenger wire size to prevent slippage. Medium and long style rings have extra length for bundles of cables or for running several cables independently from same messenger wire. Recommended spacing for ring sizes 1-1/2" through 2-1/2" (38mm through 64mm) is 15" to 20" (381mm to 508mm). Recommended spacing for ring sizes 3" through 6" (76mm through 152mm) is 12" to 15" (305mm to 381mm). Exact spacing varies depending on type of cable, nature of installation and loading requirements. When ordering cable rings, specify size, material, style and size of messenger strand.



CAB Rings are recommended for aerial cables in plants, mills, tunnels, open pit mines and pipeline projects.



CAB's Award Winning PVC coated Rings and Saddles have a heavy coating of high dielectric grade, UV stabilized PVC plastisol.



Cables can be run separately by using CAB's standard and long style rings.

CAB Sizing Guide

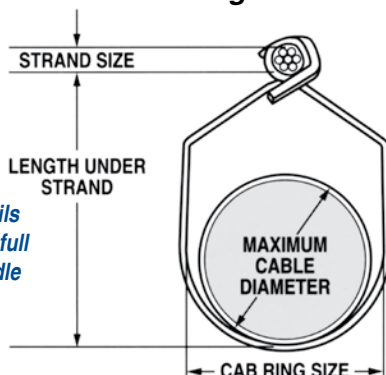

For more details ask for CAB's full Ring and Saddle brochure!

Standard Style CAB Rings

Medium and long styles also available.

Ring Diameter	Maximum Cable Diameter	Length Under Strand	Standard Rings Packaging	Standard Rings Weight/Box	PVC Coated Rings Packaging	PVC Coated Rings Weight/Box
1-1/2" (38mm)	1-1/8" (29mm)	2-1/2" (64mm)	500/box	25 lb. (11.4kg)	250/box	18 lb. (8.2kg)
2" (51mm)	1-1/2" (38mm)	2-7/8" (73mm)	250/box	19 lb. (8.6kg)	100/box	10 lb. (4.5kg)
2-1/2" (64mm)	2" (51mm)	3-1/2" (89mm)	250/box	26 lb. (11.8kg)	100/box	12 lb. (5.5kg)
3" (76mm)	2-1/4" (57mm)	4-1/8" (105mm)	100/box	12 lb. (5.5kg)	100/box	18 lb. (8.2kg)
3-1/2" (89mm)	2-5/8" (67mm)	4-1/2" (114mm)	100/box	13 lb. (5.9kg)	100/box	21 lb. (9.5kg)
4" (102mm)	3" (76mm)	5" (127mm)	100/box	19 lb. (8.6kg)	50/box	14 lb. (6.4kg)
4-1/2" (114mm)	3-1/2" (89mm)	5-1/2" (140mm)	100/box	19 lb. (8.6kg)	50/box	15 lb. (6.8kg)
5" (127mm)	4" (102mm)	6-1/4" (159mm)	50/box	11 lb. (5.0kg)	50/box	16 lb. (7.3kg)
6" (152mm)	5" (127mm)	7-1/4" (184mm)	50/box	12 lb. (5.5kg)	50/box	18 lb. (8.2kg)

CAB® Cable Pullers

Made for the Tough Job of Pulling Trailing Cables in Underground and Open Pit Mines

CAB Cable Pullers are far safer than alternatives such as chain and hemp rope. They are very effective in safety programs designed to reduce mine accidents and back injuries.

Note: Cable Pullers are not designed for lifting.

**Insulated Steel Cable Puller
CAB 878
CAB 879**

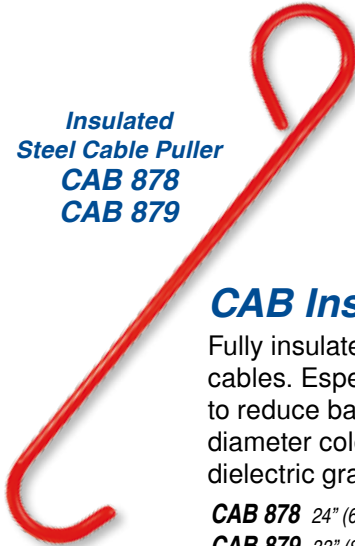

CAB Insulated Steel Cable Pullers

Fully insulated steel pull hooks for manually moving trailing cables. Especially useful in safety programs designed to reduce back injuries. Manufactured from 3/8" (10mm) diameter cold rolled steel with heavy coating of high dielectric grade plastisol for added protection.

CAB 878 24" (610mm) pull hook, 6/box, 12 lbs. (5.5kg)

CAB 879 33" (838mm) pull hook, 6/box, 14 lbs. (6.4kg)

More effective at gripping cables than slings... lower cost, too!



CAB Webbing Cable Pullers

Made from heavy duty polypropylene webbing that provides a wide support area for pulling cables. More cost effective than slings and the webbing is not as stiff, so they provide more effective gripping and holding of cables without slippage. For added versatility, one end loop is 11" (279mm) long; the other is 14" (356mm) long. Bright yellow color provides high visibility.



Webbing Cable Puller

2" (51mm) Wide Webbing:

CAB 6371 5 ft. (1.5m) long, 10/box, 6 lbs. (2.7kg)

CAB 6372 6 ft. (1.8m) long, 10/box, 7 lbs. (3.2kg)

CAB 6370 8 ft. (2.4m) long, 10/box, 9 lbs. (4.1kg)

CAB 6373 10 ft. (3.0m) long, 10/box, 12 lbs. (5.5kg)

3" (76mm) Wide Webbing:

CAB 6323 5 ft. (1.5m) long, 10/box, 10 lbs. (4.5kg)

CAB 6324 6 ft. (1.8m) long, 10/box, 10 lbs. (4.5kg)

CAB 6314 8 ft. (2.4m) long, 10/box, 13 lbs. (5.9kg)

CAB 6325 10 ft. (3.0m) long, 10/box, 17 lbs. (7.7kg)

CAB Rope Cable Pullers

Made from strong 7/8" (22mm) diameter hollow braid polypropylene rope. Heavy duty spliced knot on both ends prevents pull-out and provides secure 4" (102mm) end loops.

CAB 5142 7/8" (22mm) rope, 5 ft. (1.5m) long, 10/box, 10 lbs. (4.5kg)

CAB 6009 7/8" (22mm) rope, 8 ft. (2.4m) long, 10/box, 12 lbs. (5.5kg)

CAB 7258 7/8" (22mm) rope, 10 ft. (3m) long, 10/box, 14 lbs. (6.4kg)

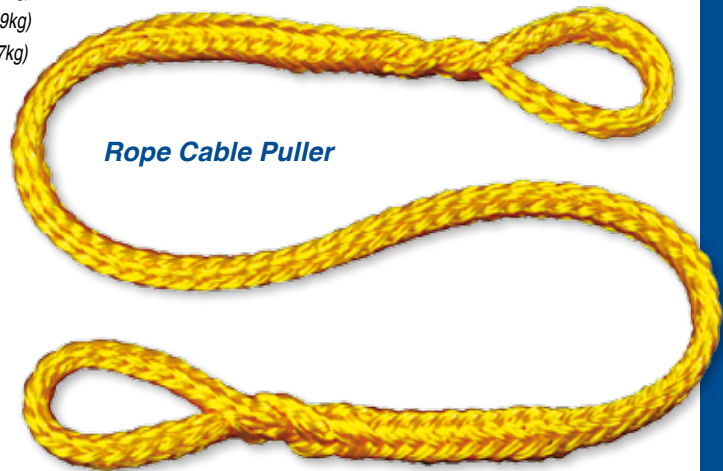

Rope Cable Puller



**Heavy Duty Webbing Hanger
CAB 7630**



Available with heavy duty hooks.

CAB Heavy Duty Webbing Hangers

Made for hanging PVC pipe in underground applications. 4" (102mm) wide black polypropylene webbing with 3" (76mm) loops on each end. Hanger pictured has folded loops for double thickness when hanging with chain. Also available with 1/4" (6.4mm) or 3/8" (10mm) diameter wire hooks on each end for hanging from plates or structure.

CAB 7630 30" (762mm) long, no hooks, 50/box, 11 lbs. (5kg)

CAB 830 41" (1m) long, 1/4" (6.4mm) dia. wire hooks, 1/2" (13mm) top loop, 25/box, 15 lbs. (6.8kg)

CAB 831 35" (889mm) long, 3/8" (10mm) dia. wire hooks, 3/4" (19mm) top loop, 25/box, 37 lbs. (16.8kg)

CAB 832 41" (1m) long, 3/8" (10mm) dia. wire hooks, 3/4" (19mm) top loop, 25/box, 39 lbs. (17.7kg)