









FS and FD Two Gang Cast Device Boxes

CSA Certification Only.

UNILETS® for use with Threaded Rigid Conduit and IMC.

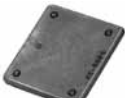
	Description	Catalog Number	Wt. Lbs./Kgs. Per 100
Two Gang Covers			
	Blank Cover, Steel – Zinc Electroplate	FS-42 *	20.00/9.07
	Round Receptacle Cover, Steel – Zinc Electroplate Hole dia. 1-7/16"	FS-52 *	18.00/8.16
	Duplex Receptacle Cover, Steel-Zinc Electroplate	FS-62 *	15.00/6.80
	Tumbler Switch Cover, Steel –Zinc Electroplate	FS-92 *	20.00/9.07
	Combination Duplex Receptacle and Tumbler Switch Cover, Steel - Zinc Electroplate	FS-69 *	15.00/6.80
	Combination Duplex Receptacle and Single Receptacle, Steel - Zinc Electroplate	FS-65 *	15.00/6.80
Weatherproof Covers			
	Blank Cover, Gray Iron	FS-200G *	56.00/25.40
	For external operation of tumbler switches with square handles	FSK-2VTS	250.00/113.40
Gasket – Replacement			
	Neoprene - for use with 2-gang cast covers above	FS-GKR-2N	—

* Available in Aluminum: Add suffix -A to catalog number.

✦ CSA Certification Only.

FS and FD Three Gang Cast Device Boxes

CSA Certification Only.

UNILETS® for use with Threaded Rigid Conduit and IMC. All device boxes have ridge top construction.

Size	Gray Iron		Aluminum	
	Catalog Number	Wt. Lbs./Kgs.	Catalog Number	Wt. Lbs./Kgs.

FS Three Gang Bodies



3/4	Shallow	FSC-23	3.60/1.63	Shallow	FSC-23A	1.20/0.54
1	Deep	FDC-33	4.00/1.81	Deep	FDC-33A	1.33/0.60

Description	Catalog Number	Wt. Lbs./Kgs. Per 100
-------------	----------------	-----------------------

Three Gang Covers



Duplex Receptacle Cover, Steel – Zinc Electroplate **FS-63 *** 23.00/10.43



Tumbler Switch, Steel –Zinc Electroplate **FS-93 *** 25.00/11.34

Weatherproof Covers



Blank Cover, Gray Iron **FS-300G *** 120.00/54.43



For external operation of tumbler or toggle switches with square handles **FSK-3VTS** 330.00/149.69

Dimensions in Inches/Millimeters

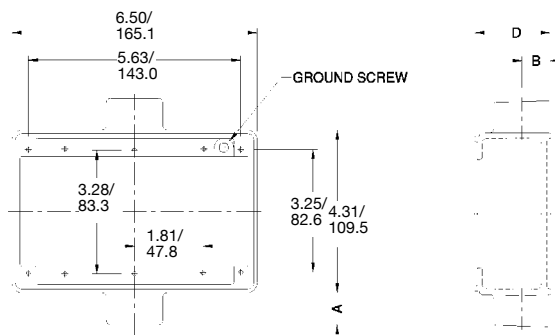

Three Gang Devices

Hub Size	D					
	A	B	C	FS	FD	E
1/2	0.75/ 19.1	0.63/ 16.0	1.38/ 35.1	2.00/ 50.8	2.75/ 69.9	2.19/ 55.6
1	0.88/ 22.4	0.88/ 22.4	1.25/ 31.8	2.00/ 50.8	2.75/ 69.9	2.19/ 55.6

* Available in Aluminum: Add suffix -A to catalog number.

 CSA Certification Only.