



MasterColor CDM-TD 70W/830 RX7s T6 CL

Product family description

Product data	
Product Number	231605
Full product name	MasterColor CDM-TD 70W/830 RX7s T6 CL
Ordering Code	231605
Pack type	1 Lamp in a Folding Carton
Pieces per Sku	1
Skus/Case	12
Pack UPC	046677231606
EAN2US	
Case Bar Code	50046677231601
Successor Product number	
Base	Recessed Single Contact RX7s
Bulb	T6 [T 22mm]
Bulb Finish	Clear
Operating Position	Horizontal +/- 45 D [Parallel +/-45D or Horizontal(HOR)]
Packing Type	1CT [1 Lamp in a Folding Carton]
Packing Configuration	12
Ordering Code	CDM70/TD/830
Pack UPC	046677231606
Case Bar Code	50046677231601
ANSI Code HID	M139/E
System Power EL	83 W
Watts	70W
Lamp Voltage	92 V
Dimmable	No
Color Code	830 [CCT of 3000K]
Color Rendering Index	82 Ra8
Color Designation	Warm White

Product data	
Color Description	830 Warm White
Color Temperature	3000 K
Initial Lumens	6500 Lm
Design Mean Lumens	- Lm
Overall Length C	119.63 mm
Diameter D	22 mm
Light Center Length L	2.25 in
Max Overall Length (MOL) - C	4.6875 in
Diameter D	0.75 in
Product Number	231605



CDM-TD

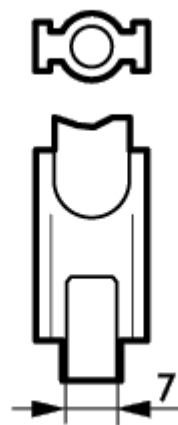

Cap-Base RX7s

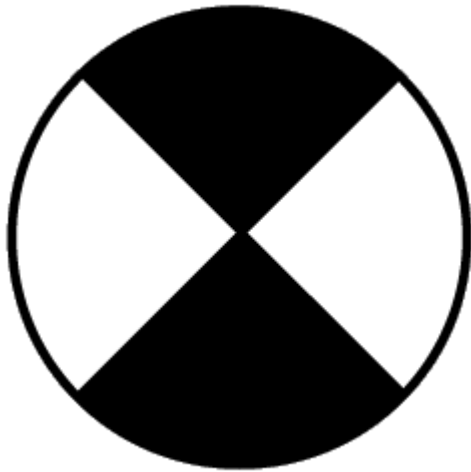

Operating Position p45

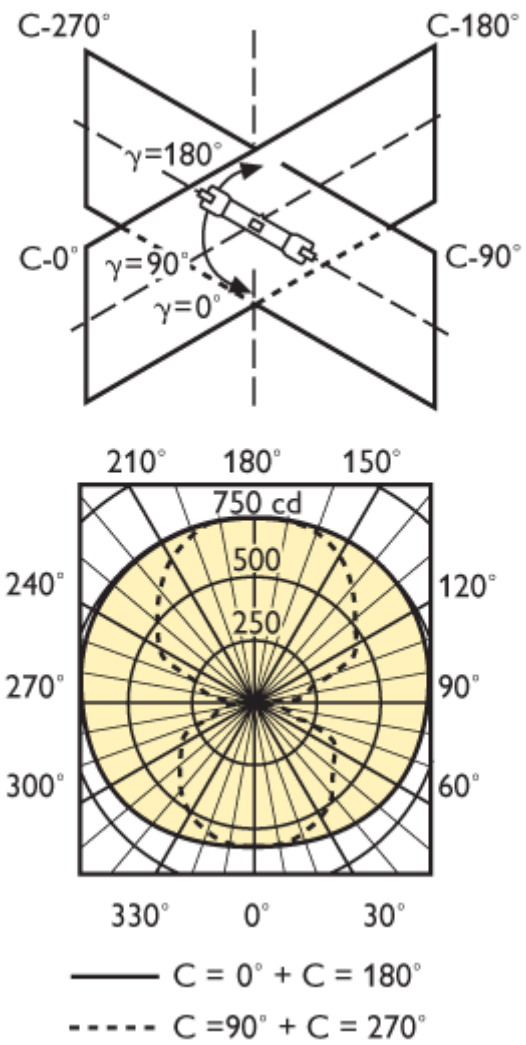

CDM-TD

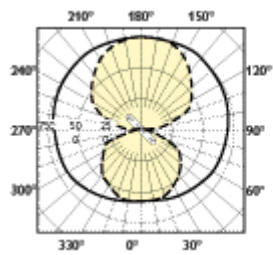

CDM-TD

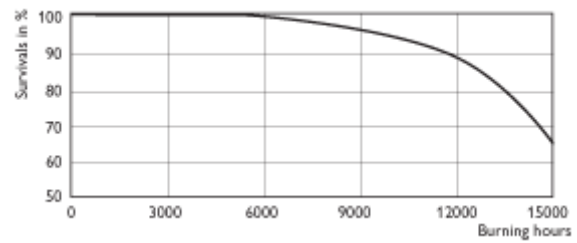

CDM-TD

no image available

CDM-TD

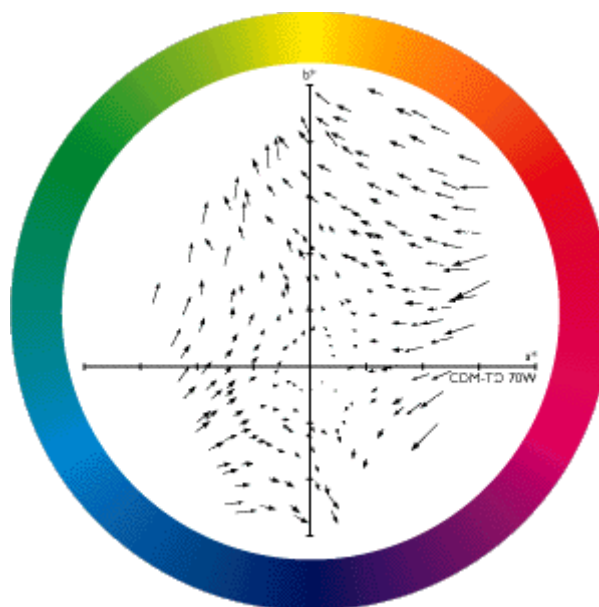

CDM-TD

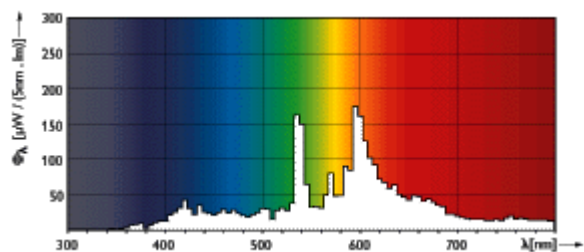

CDM-TD

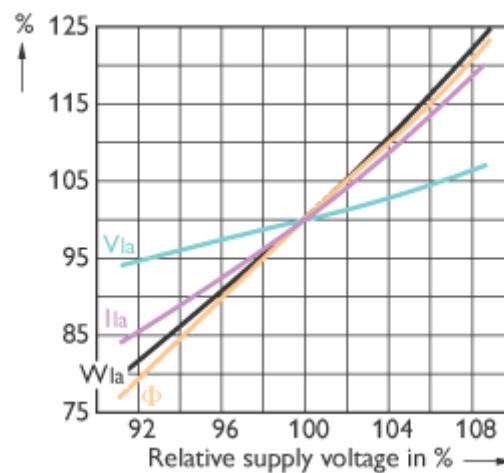

CDM-TD

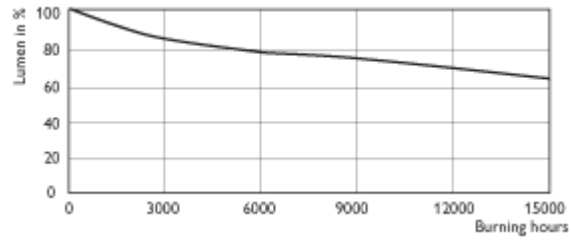

CDM-TD

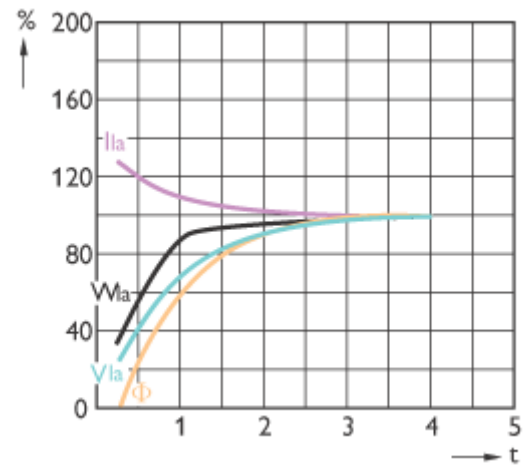

CDM-TD

