

PLX
LED PANEL

Type: _____

Project: _____

Low profile frame is just 0.5" thick



DIFFUSERS: Layers of light-shaping diffusers for uniform light distribution

FRAME: White powder coated extruded aluminum frame

Delivered Lumens:
1203 lm

Input Wattage:
20W

Efficacy:
71 lm/W

Colour Temperatures:
3000K
4000K
5700K

Projected Lumen Maintenance:
L₇₀ @ >50,000 hrs.

INSTALLATION:
Suitable for use in insulated ceilings

■ **APPLICATIONS:** The PLANEX® is ideal for hospitality, healthcare, offices, banks, retail, hotels, restaurants and schools

CONFIGURATIONS

MODEL	SIZE	COLOUR TEMPERATURE	INPUT
PLX	1 (1' x 1')	WT30 (3000K)	120/277V
		WT40 (4000K)	
		WT57 (5700K)	

ACCESSORIES (ORDER SEPARATELY)

MOUNTING	SPIRAL CORD	INPUT
SPS (32" aircraft cable)	SPCW (spiral cord white)	347V
SM (Surface mount)	SPCB (spiral cord black)	
RM (Recessed mount)		

MECHANICAL: Extruded aluminum frame with a white powder coat finish.

ELECTRICAL: Driver operates 100V-277V, 50-60Hz. Optional 347V transformer is available - sold separately. For transformer sizes, consult factory.

INPUT POWER: 20W for the 1x1.

DIMMING: Not available on the 1x1.

LEDS: White LEDs are offered in 3000K, 4000K & 5700K colour temperatures. Over 50,000 hour LED life at L₇₀.

Also available in 2x2, 1x4, 2x4

DIFFUSION: Layers of light shaping diffusers provide effective and uniform light distribution without glare or hot spots.

WARRANTY: 5 year LED warranty, see website for full warranty details.

- MOUNTING:**
Shipped separately
- Grid ceilings (standard)
 - 32" Adjustable suspension mount kit (SPS)
 - Surface mount kit (SM) for wall or ceiling
 - Recessed mount kit (RM) for drywall - wall or ceiling

Size	A	B	C	D
1x1	11.8"	11.8"	1.8"	0.5"
1x1	300 mm	300 mm	46 mm	13 mm

PLANEX-1-WT40-120/277V

CANDELA DISTRIBUTION

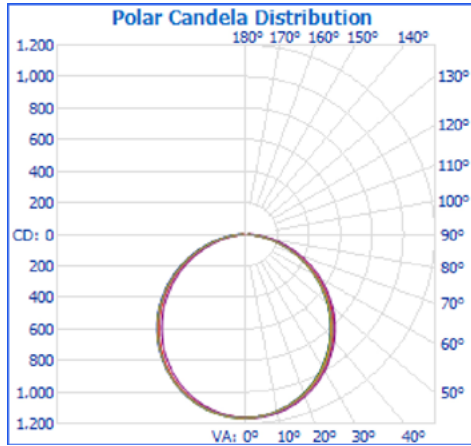

Efficiency Total: 100% Lumen Rating: 1203
 Efficacy Total: 71 lm/W Input Wattage: 20W

ZONAL LUMEN SUMMARY

ZONE	LUMENS	% LAMP/LUMINAIRE
0-60	78.52	78.52%
60-90	21.48	21.48%
0-90	1203	100.0%
90-180	0.0	0.0%
0-180	1203	100.0%

Tested in accordance with IESNA LM-80-08

ENERGY COMPARISON CHART

MODEL	EFFICACY	INPUT WATTAGE	LUMEN OUTPUT	CRI	Lifespan
PLANEX 1'x1' 4000K	71 lm/W	20W	1203	80+	50,000

*Projected

PLX
LED PANEL

DESIGNLIGHTS CONSORTIUM™ QUALIFIED AS:
LUMINAIRES FOR AMBIENT LIGHTING OF INTERIOR COMMERCIAL SPACES

Type: _____

Project: _____

Suitable for damp locations

Low profile frame is just 0.5" thick



DIFFUSERS: Layers of light-shaping diffusers for uniform light distribution

INSTALLATION: Suitable for use in insulated ceilings

■ **APPLICATIONS:** The PLANEX® is ideal for hospitality, healthcare, offices, banks, retail, hotels, restaurants and schools

DIMMING: Built in 3-in-1 dimming function is standard on 2'x2'

FRAME: White powder coated extruded aluminum frame

Delivered Lumens:
3277 lm

Input Wattage:
40W

Efficacy:
82 lm/W

Colour Temperatures:
3000K
3500K
4000K
5000K

Projected Lumen Maintenance:
L₇₀ @ > 50,000 hrs.

CONFIGURATIONS

MODEL	SIZE	COLOUR TEMPERATURE	INPUT
PLX	2 (2' x 2')	WT30 (3000K)	120/277V
		WT35 (3500K)	
		WT40 (4000K)	
		WT50 (5000K)	

ACCESSORIES (ORDER SEPARATELY)

EMERGENCY	MOUNTING	SPIRAL CORD	INPUT
EM (Remote emergency, 90 min.)	SPS (50" aircraft cable)	SPCW (spiral cord white)	347V
	SM (Surface mount)	SPCB (spiral cord black)	
	RM (Recessed mount)		

MECHANICAL: Extruded aluminum frame with a white powder coat finish.

ELECTRICAL: Driver operates 100V-277V, 50-60Hz. Optional 347V transformer is available - sold separately. For transformer sizes, consult factory.

INPUT POWER: 40W for the 2x2.

DIMMING: Built in 3-in-1 dimming function

- 1-10V down to 10%
- PWM
- Resistance

Also available in 1x1, 1x4, 2x4

LEDs: White LEDs are offered in 3000K, 3500K, 4000K & 5000K colour temperatures. Over 50,000 hour LED life at L₇₀.

MOUNTING: Accessories are shipped separately

- Grid ceilings (standard)
- 50" Adjustable suspension mount kit (SPS)
- Surface mount kit (SM) for wall or ceiling
- Recessed mount kit (RM) for drywall - wall or ceiling

EMERGENCY: 1300 lumens for a minimum 90 minute duration. 120V only.

DIFFUSION: Layers of light shaping diffusers provide effective and uniform light distribution without glare or hot spots.

WARRANTY: 5 year LED warranty, see website for full warranty details.

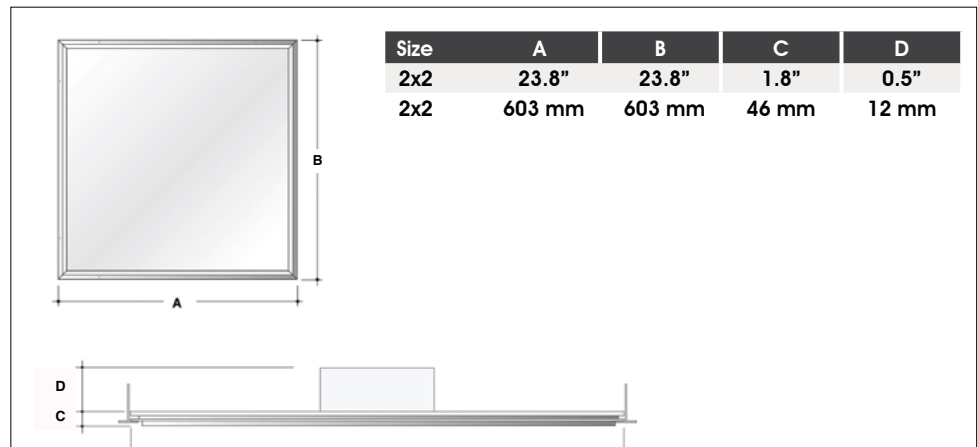

PLANEX-2-WT50-120/277V

CANDELA DISTRIBUTION

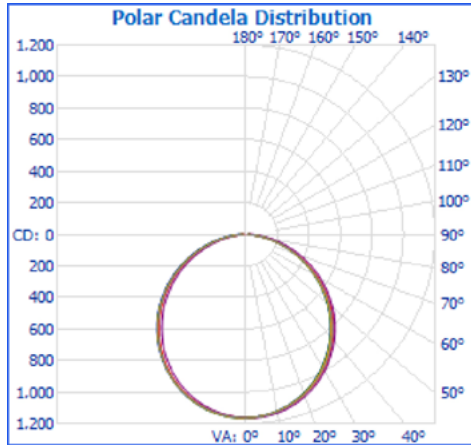

Efficiency Total: 100% Lumen Rating: 3464
 Efficacy Total: 93 lm/W Input Wattage: 40W

ZONAL LUMEN SUMMARY

ZONE	LUMENS	% LAMP/LUMINAIRE
0-60	2871.8	78.2%
60-90	800.5	21.8%
0-90	3672.3	100.0%
90-180	0.0	0.0%
0-180	3672.3	100.0%

Tested in accordance with IESNA LM-80-08

PLANEX-2-WT40-120/277V

CANDELA DISTRIBUTION

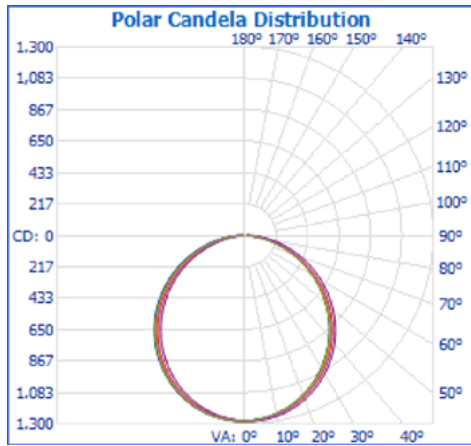

Efficiency Total: 100% Lumen Rating: 3277
 Efficacy Total: 82 lm/W Input Wattage: 40W

ZONAL LUMEN SUMMARY

ZONE	LUMENS	% LAMP/LUMINAIRE
0-60	2625.5	78.1%
60-90	736.6	21.9%
0-90	3362.1	100.0%
90-180	0.0	0.0%
0-180	3362.1	100.0%

Tested in accordance with IESNA LM-80-08

ENERGY COMPARISON CHART

MODEL	EFFICACY	INPUT WATTAGE	LUMEN OUTPUT	CRI	BEAM ANGLE	*L70 (HRS.)
PLANEX 2'x2' 4000K	82 lm/W	40W	3277	80+	113°	50,000
PLANEX 2'x2' 5000K	93 lm/W	40W	3464	80+	113°	50,000

*Projected

PLX
LED PANEL

DESIGNLIGHTS CONSORTIUM™ QUALIFIED AS:
LUMINAIRES FOR AMBIENT LIGHTING OF INTERIOR COMMERCIAL SPACES

Type: _____

Project: _____

Low profile frame is just 0.5" thick

Suitable for damp locations

DIMMING: Built in 3-in-1 dimming function is standard on 1'x4'

INSTALLATION: Suitable for use in insulated ceilings

■ **APPLICATIONS:** The PLANEX® is ideal for hospitality, healthcare, offices, banks, retail, hotels, restaurants and schools

DIFFUSERS: Layers of light-shaping diffusers for uniform light distribution

FRAME: White powder coated extruded aluminum frame

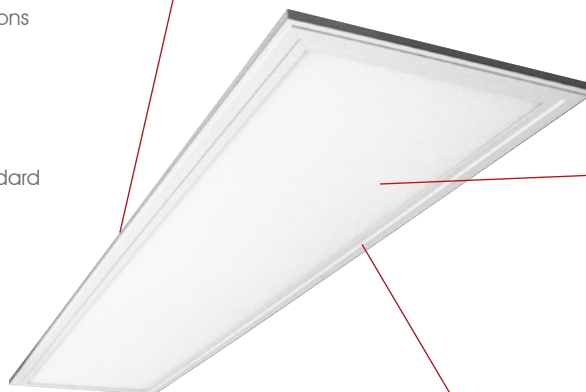

Delivered Lumens:
3285 lm

Input Wattage:
40W

Efficacy:
87 lm/W

Colour Temperatures:
3000K
3500K
4000K
5000K

Projected Lumen Maintenance:
L₇₀@ >50,000 hrs.

CONFIGURATIONS

MODEL	SIZE	COLOUR TEMPERATURE	INPUT
PLX	14 (1' x 4')	WT30 (3000K)	120/277V
		WT35 (3500K)	
		WT40 (4000K)	
		WT50 (5000K)	

ACCESSORIES (ORDER SEPARATELY)

	MOUNTING	SPIRAL CORD	INPUT
EM (Remote emergency, 90 min.)	SPS (50" aircraft cable)	SPCW (spiral cord white)	347V
	SM (Surface mount)	SPCB (spiral cord black)	
	RM (Recessed mount)		

MECHANICAL: Extruded aluminum frame with a white powder coat finish.

ELECTRICAL: Driver operates 100V-277V, 50-60Hz. Optional 347V transformer is available - sold separately. For transformer sizes, consult factory.

INPUT POWER: 40W for the 1x4.

DIMMING: Built in 3-in-1 dimming function

- 1-10V down to 10%
- PWM
- Resistance

Also available in 1x1, 2x2, 2x4

LEDs: White LEDs are offered in 3000K, 3500K, 4000K & 5000K colour temperatures. Over 50,000 hour LED life at L₇₀.

DIFFUSION: Layers of light shaping diffusers provide effective and uniform light distribution without glare or hot spots.

MOUNTING: Accessories are shipped separately

- Grid ceilings (standard)
- 50" Adjustable suspension mount kit (SPS)
- Surface mount frame (SM) for wall or ceiling
- Recessed mount kit (RM) for drywal - ceiling

WARRANTY: 5 year LED warranty, see website for full warranty details.

Size	A	B	C	D
1x4	11.8"	47.7"	1.8"	0.5"
1x4	300 mm	1212 mm	46 mm	12 mm

PLANEX-14-WT50-120/277V

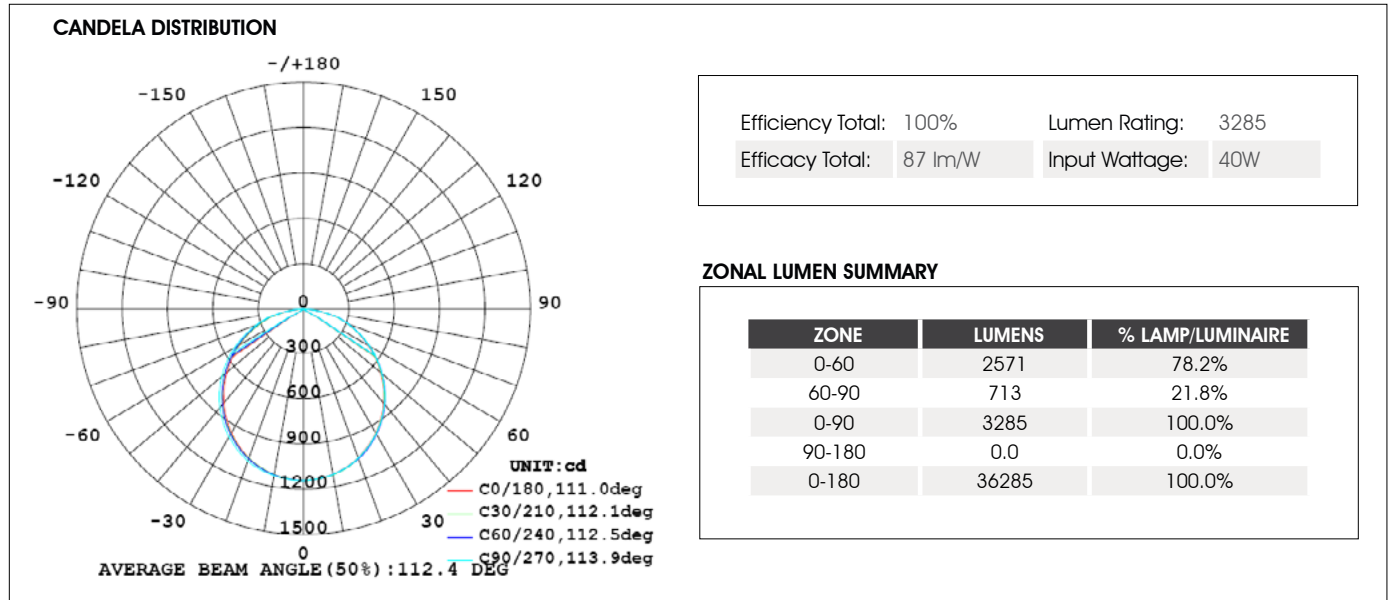

Tested in accordance with IESNA LM-80-08

ENERGY COMPARISON CHART

MODEL	EFFICACY	INPUT WATTAGE	LUMEN OUTPUT	CRI	BEAM ANGLE	*L70 (HRS.)
PLANEX 1'x4' 5000K	87 lm/W	40W	3285	80+	113°	50,000

*Projected

PLANEX
LED PANEL

DESIGNLIGHTS CONSORTIUM™ QUALIFIED AS:
LUMINAIRES FOR AMBIENT LIGHTING OF INTERIOR COMMERCIAL SPACES

Type: _____

Project: _____

Suitable for damp locations

Low profile frame is just 0.5" thick

Delivered Lumens:
6541 lm

Input Wattage:
77W

Efficacy:
85 lm/W

Colour Temperatures:
3000K
3500K
4000K
5000K

Projected Lumen Maintenance:
L₇₀@ >50,000 hrs.

DIMMING: Built in 3-in-1 dimming function is standard on 2'x4'

INSTALLATION: Suitable for use in insulated ceilings

■ **APPLICATIONS:** The PLANEX® is ideal for hospitality, healthcare, offices, banks, retail, hotels, restaurants and schools



DIFFUSERS: Layers of light-shaping diffusers for uniform light distribution

FRAME: White powder coated extruded aluminum frame

CONFIGURATIONS

MODEL	SIZE	COLOUR TEMPERATURE	INPUT
PLX	4 (2' x 4')	WT30 (3000K)	120/277V
		WT35 (3500K)	
		WT40 (4000K)	
		WT50 (5000K)	

ACCESSORIES (ORDER SEPARATELY)

	MOUNTING	SPIRAL CORD	INPUT
EM (Remote emergency, 90 min.)	SPS (50" aircraft cable)	SPCW (spiral cord white)	347V
	SM (Surface mount)	SPCB (spiral cord black)	
	RM (Recessed mount)		

MECHANICAL: Extruded aluminum frame with a white powder coat finish.

ELECTRICAL: Driver operates 100V-277V, 50-60Hz. Optional 347V transformer is available - sold separately. For transformer sizes, consult factory.

INPUT POWER: 77W for the 2x4.

DIMMING: Built in 3-in-1 dimming function

- 1-10V down to 10%
- PWM
- Resistance

Also available in 1x1, 2x2, 1x4

LEDS: White LEDs are offered in 3000K, 3500K, 4000K & 5000K colour temperatures. Over 50,000 hour LED life at L₇₀.

DIFFUSION: Layers of light shaping diffusers provide effective and uniform light distribution without glare or hot spots.

MOUNTING: Accessories are shipped separately

- Grid ceilings (standard)
- 50" Adjustable suspension mount kit (SPS)
- Surface mount frame (SM) for wall or ceiling
- Recessed mount kit (RM) for drywall - ceiling

WARRANTY: 5 year LED warranty, see website for full warranty details.

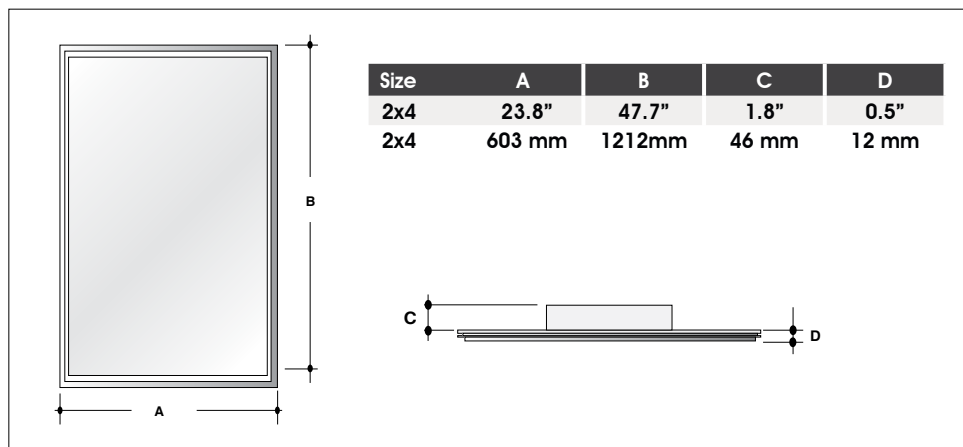

PLANEX-4-WT40-120/277V

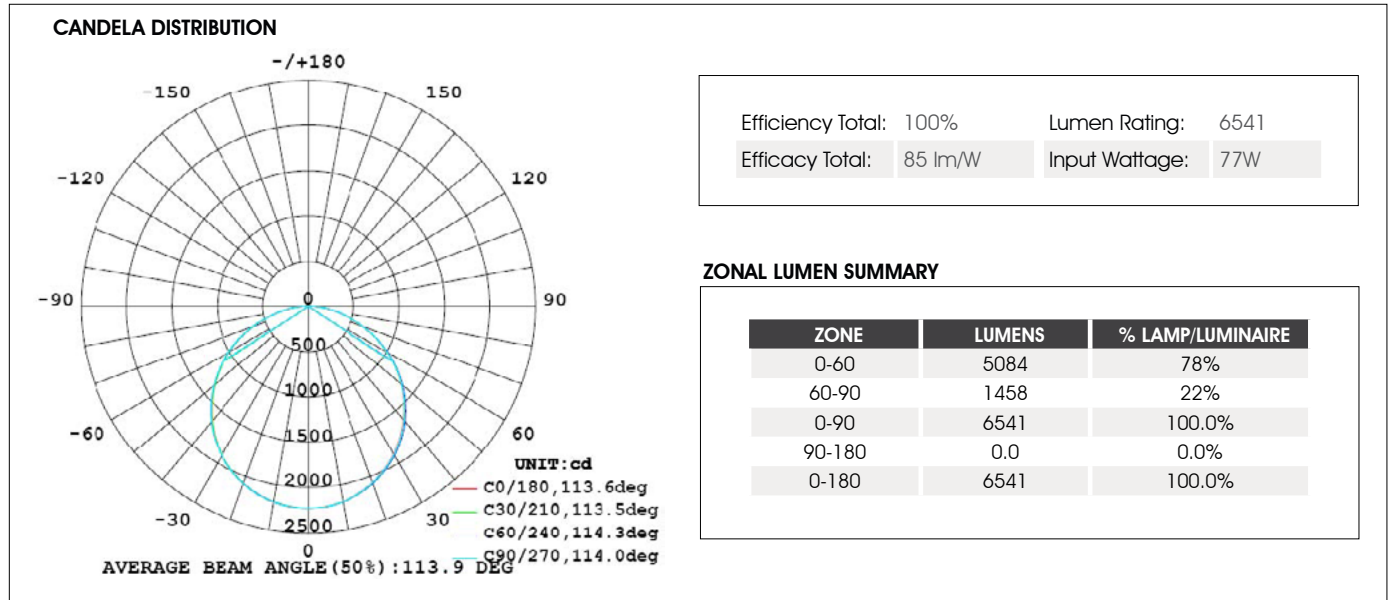

Tested in accordance with IESNA LM-80-08

ENERGY COMPARISON CHART

MODEL	EFFICACY	INPUT WATTAGE	LUMEN OUTPUT	CRI	BEAM ANGLE	*L70 (HRS.)
PLANEX 2'x4' 4000K	85 lm/W	77W	6541	80+	113°	50,000

*Projected