



Pass & Seymour

Wall Plates Dustproof Stainless Steel Covers One & Two Gang

WP1, WP2, WP7, WP8, WPH8, WP26, WPH26, WP13, WP23, WPH1-L, WPH7-L, WPH8-L, WP26-L

Exceptional durability plus dust protection.

These brushed stainless steel dust covers are designed to handle challenging conditions including dusty, corrosive environments, or hard-use areas. Yet they provide a smooth, handsome style that fits in anywhere. Note: these covers are not suitable for wet locations — see our Weatherproof Covers if water resistance is required.



Features & Benefits

Aesthetically pleasing design.

These stainless steel covers are dustproof only and do not meet NEC 406.8(A) or (B).



Stainless steel springs.

Made of .030 inch thick 302 brushed stainless steel to help protect against corrosion.









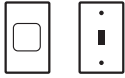
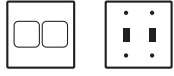

WP26-L

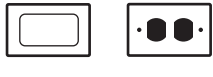
Field Uses/Vertical Markets

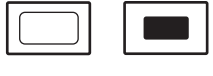
- Industrial
- Health Care
- Education
- Institutional
- Retail
- Office
- Hospitality/Lodging
- Multiple Dwelling

Wall Plates Dustproof Stainless Steel Covers One & Two Gang

Ordering Information

| Catalog Number | Description |
|---|--|
| One & Two Gang Dust Covers | |
|  WP1 | 1 Toggle Switch 1 Small Cover, Vertical 1 Gang Plate Available for Box Mount – add suffix -FS. |
|  WP2 | 2 Toggle Switches 2 Small Covers, Vertical 2 Gang Plate |
|  WP7 | 1 Single Receptacle 1 Small Cover, Vertical 1 Gang Plate Available for Box Mount – add suffix -FS. |
|  WP8 | 1 Duplex Receptacle 1 Long Cover, Vertical 1 Gang Plate |
|  WPH8 | 1 Duplex Receptacle 1 Long Cover, Horizontal 1 Gang Plate |
|  WP26 | 1 Decorator/GFCI 1 Long Cover, Vertical 1 Gang Plate |
|  WPH26 | 1 Decorator/GFCI 1 Long Cover, Horizontal 1 Gang Plate |
|  WP13 | 1 Gang Blank (Box Mounted) Gasketed |
|  WP23 | 2 Gang Blank (Box Mounted) Gasketed |
| Locking Dust Covers | |
|  WPH1-L | Toggle Opening Horizontal |
|  WPH7-L | Single Receptacle Opening Horizontal |
|  WPH8-L | Duplex Receptacle Opening Horizontal |
|  WP26-L | Decorator/GFCI Vertical |
| WP255-K | Key for all Dustproof Locking Covers. (Two keys furnished with each unit.) |

For more information on these and other P&S products refer to our Product Guide or visit our web site.

Wall Plates Dustproof Stainless Steel Covers One & Two Gang



Pass & Seymour

Technical Specifications

| 3rd Party Compliance | |
|------------------------------|--|
| UL Listed. CSA Certified. | |

| Performance | |
|---------------|----------------|
| Environmental | Dustproof Only |

| Materials | |
|-----------|---------------------------|
| Body | .030" 302 Stainless Steel |
| Finish | Brushed |
| Springs | Stainless Steel 17-7 |
| Screws | 302 Stainless Steel |
| Gasket | Vinyl |
| Lock | Stainless Steel |

Warranty

1 Year

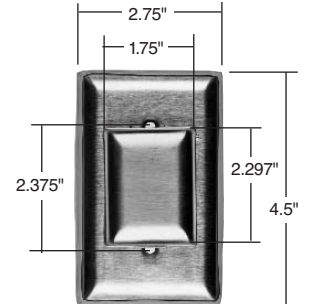

Dimensions for
WP1 & WP7

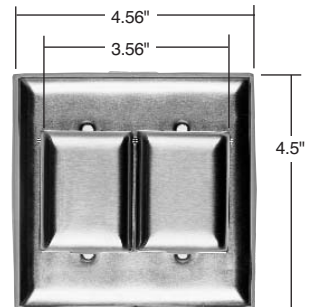

Dimensions for
WP2

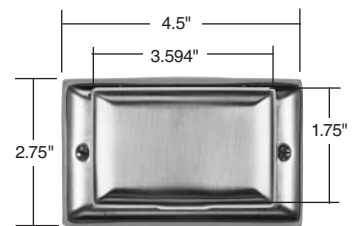

Dimensions for
WPH8 & WPH26

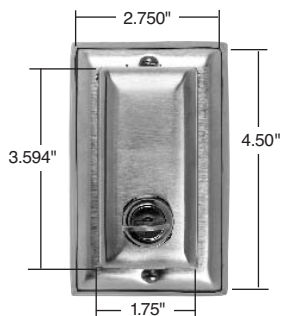

Dimensions for
Vertical Locking



Dimensions for
Horizontal Locking

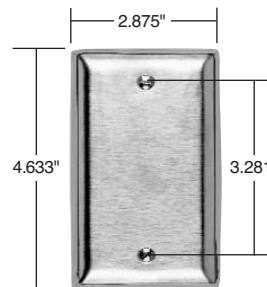

Dimensions for
WP13

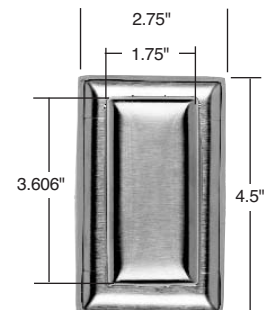

Dimensions for
WP8 & WP26

Complementary Devices & Accessories



WALL PLATES

- TradeMaster® Thermoplastic Nylon
- Stainless Steel
- Brass
- Aluminum

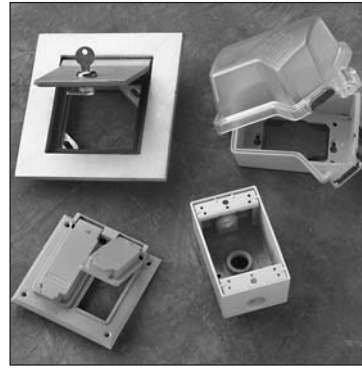

WEATHERPROOF BOXES & COVERS

- While-In-Use Covers
- Heavy Cast Aluminum Covers
- Cast Covers
- Boxes

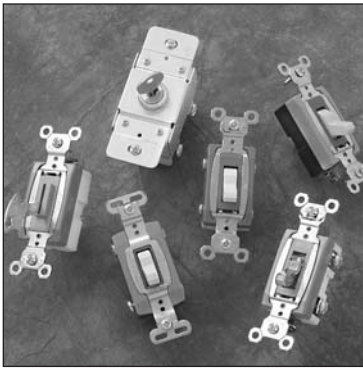

SWITCHES

- Heavy-Duty Toggle
- Heavy-Duty Lighted Toggle
- Heavy-Duty Security
- Heavy-Duty Locking
- Construction Grade Toggle
- Commercial Grade Toggle

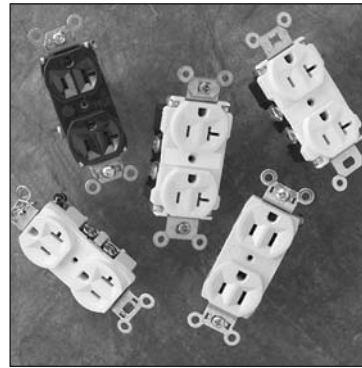

STRAIGHT BLADE RECEPTACLES

- Extra Heavy-Duty
- Heavy-Duty
- Construction Grade
- Commercial Grade

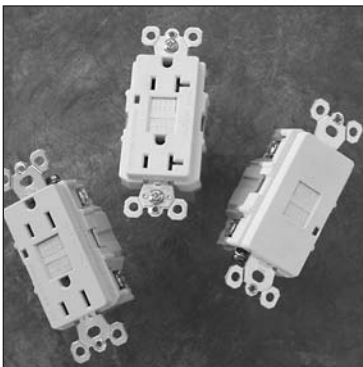

GFCIs

- Construction Grade with Auto-Ground
- Construction Grade
- Construction Grade Dead Front

Also available...

- Light Almond Devices
- Decorator Devices
- Hospital Grade Devices
- PlugTail™ Devices
- TVSS & Isolated Ground Devices
- Ground Continuity Monitoring (GCM)
- Straight Blade Plugs & Connectors
- Turnlok® Locking Devices
- IEC 309 Industrial Products
- Flexcor® Wire Mesh Grips
- Configurable Solutions



Legrand/Pass & Seymour
P.O. Box 4822
Syracuse, NY 13221-4822
800-223-4185

North America Headquarters
60 Woodlawn Street
West Hartford, CT 06110
Phone: 1.877.BY.LEGRAND (295.3472)
Fax: 1.860.232.2062
www.legrand.us

Legrand Canada
570 Applewood Crescent
Vaughan, ON, L4K 4B4
Phone: 905.738.9195
Fax: 905.738.9721
www.legrand.ca