



# MARCUS

Marcus Transformer LTD  
 Phone: 1-800-267-7376  
 Fax: 1-866-205-7526  
 Email: Info@marcustransformer.com

## TECHNICAL DATA

SINGLE PHASE CONTROL TRANSFORMER

### DESCRIPTION

MODEL	MO150E
Type	Open
VA	150
Primary (Volts)	240 / 480
Secondary (Volts)	120 / 240
Input /Output Amps	0.63 , 0.31 / 1.25 , 0.63
Temperature Rise	80°C
Insulation Class	B (130°C)
Frequency	60Hz
Polarity	additive
Noise level	less than 40DB
Winding	Copper
Approvals	CE compliant UL listed CSA approved

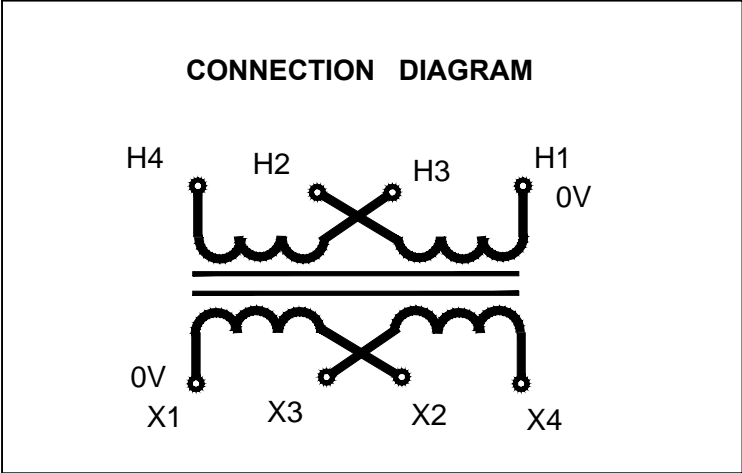

### WIRING CONNECTION

PRIMARY :		
VOLTS	INTERCONNECT:	CONNECT LINES TO :
240	H1-H3 AND H2-H4	H1-H4
480	H2-H3	H1-H4
SECONDARY :		
VOLTS	INTERCONNECT:	CONNECT LINES TO :
120	X1-X3 AND X2-X4	X1-X4
240	X2-X3	X1-X4

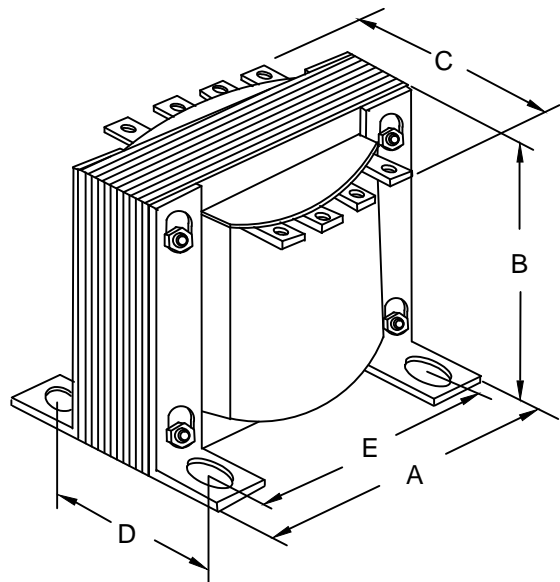

### DIMENSIONS INCHES / MM

VA	A	B	C	D	E	MOUNTING HOLES INCHES / MM	SHIP WEIGHT LBS / KG
150	3.75 95.3	3.13 79.5	4.02 102.1	3.00 76.2	3.13 79.5	0.21 x 0.625 5.3 x 15.9	5.75 2.6

Notes: